

GASKETS

 **Payen**®

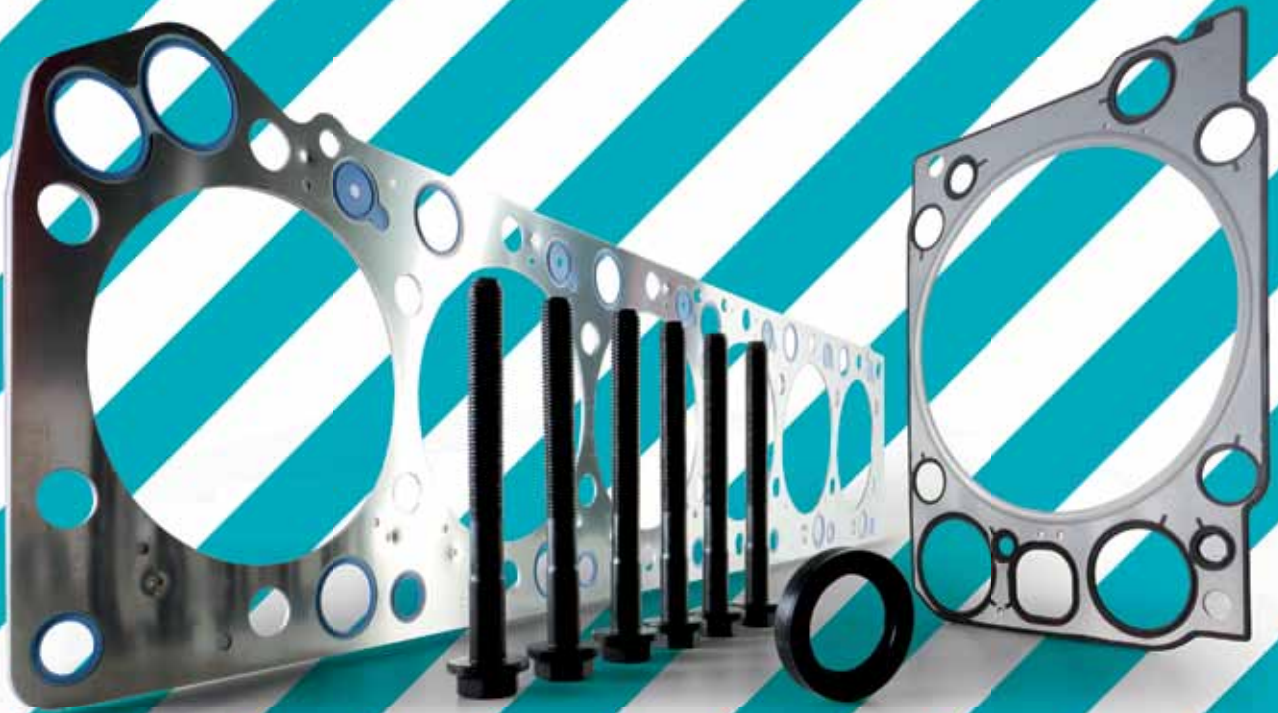

2012
2013

CATPA1101



Gaskets, Oil Seals and Cylinder Headbolts

**Dichtungen, Wellendichtringe und
Zylinderkopfschrauben**

Guarnizioni, Paraoli e Viti Testa Cilindro

Joints, Bagues d'étanchéité et Vis de culasse

Juntas, retenes de aceite y tornillos de culata

Uszczelki, uszczelnienia olejowe i śruby głowicowe

Прокладки, Сальники и Болты ГБЦ

حشيات رؤوس الأسطوانات وسدادات الزيت ومسامير رؤوس الأسطوانات

 **FEDERAL
MOGUL**



 **GLYSCO**

 **GOETZE**

Niral

 **Payen**

GASKETS



PERFORMS UNDER PRESSURE



- Wide coverage with almost 1200 references for about 3500 CV engines
- OE-specification gasket designs and materials engineered in Germany
- LEM® and HTA™ award-winning technologies included
- Innovative, market-leading anti-counterfeit programme



COMPLETE ENGINE EXPERTISE

VALVES



TOP ENGINE EXPERT



FEDERAL MOGUL AE GLYCO GOETZE Niral Payen

GASKETS



PERFORMS UNDER PRESSURE



FEDERAL MOGUL AE GLYCO GOETZE Niral Payen

www.fmeat.eu

BEARINGS



EVERY BEARING YOU NEED



FEDERAL MOGUL AE GLYCO GOETZE Niral Payen

GOETZE

THE BEST YOU CAN GET



FEDERAL MOGUL AE GLYCO GOETZE Niral Payen

PISTONS

Niral

GIVES YOU MORE



FITTED WITH GOETZE RINGS

FEDERAL MOGUL AE GLYCO GOETZE Niral Payen

CONTENTS



Contents	II
Payen history & worldwide presence	IV
Manufacturers list	V
Terms of business	VI
Federal-Mogul latest Engine & Sealing catalogues	VIII
Payen part numbering structure	IX
How to use this catalogue	X - XI
Step-by-step installation guide	XVIII
PERFORMS UNDER PRESSURE:	
A Heritage of Quality and Innovation with Payen®	XXVI - XXVII
BER Certificate	XLII
New parts list	XLIII
New engines list	XLIV
Applications by manufacturer	2
Numerical parts list	294
Interchange OE -> Payen	300
Technical notes	312



Sommario	II
Payen: storia e presenza nel mondo	IV
Elenco costruttori	V
Condizioni di vendita	VI
Ultimi cataloghi per motori e sistemi di tenuta di Federal-Mogul	VIII
Struttura dei codici articolo Payen	IX
Come utilizzare il catalogo	XII - XIII
Guida all'installazione passo a passo	XX
MASSIMA TENUTA, MASSIMA PRESTAZIONE:	
un patrimonio di Conoscenza, Qualità ed Innovazione con Payen®	XXX - XXXI
Certificazione BER	XLII
Elenco codici nuovi	XLIII
Elenco nuovi motori	XLIV
Applicazioni per produttore	2
Elenco numerico articoli	294
Intercambio OE -> Payen	300
Note tecniche	312



Inhalt	II
Historischer Überblick & weltweite Präsenz	IV
Herstellerliste	V
Verkaufsbedingungen	VI
Aktuelle Motorenteile- und Dichtungskataloge von Federal-Mogul	VIII
Payen Artikelnummernstruktur	IX
Hinweise zur Benutzung des Katalogs	X - XI
Montagehinweise Schritt für Schritt	XIX
HÖCHSTLEISTUNG UNTER DRUCK:	
Bewährte Qualität und Innovation mit Payen®	XXVIII - XXIX
GVO Zertifikat	XLII
Liste der Neuaufnahmen	XLIII
Liste neu aufgenommenen Motoren	XLIV
Anwendungen, geordnet nach Hersteller	2
Numerische Teileliste	294
Vergleichsliste OE -> Payen	300
Technische Hinweise	312



Sommaire	II
Historique et présence mondiale de Payen	IV
Index par constructeur	V
Conditions générales de vente	VI
Derniers catalogues de pièces Moteur & Etanchéité de Federal-Mogul	VIII
Structure de référencement des pièces Payen	IX
Comment utiliser ce catalogue	XII - XIII
Guide d'installation étape par étape	XXI
L'ÉTANCHÉITÉ SOUS PRESSION:	
la tradition de la qualité et de l'innovation avec Payen®	XXXII - XXXIII
Certificat REC	XLII
Liste des nouvelles références	XLIII
Liste des nouveaux moteurs	XLIV
Applications par constructeur	2
Liste des références classées par ordre alphanumérique	294
Références croisées 1ère Monte -> Payen	300
Notes techniques	312

CONTENTS



Índice	III
Historia y presencia mundial de Payen	IV
Aplicaciones por fabricante	V
Términos y condiciones de venta	VII
Últimos catálogos de juntas y motor de Federal-Mogul	VIII
Estructura de referencias de Payen	IX
Cómo usar este catálogo	XIV - XV
Manual de instalación paso a paso	XXII
FUNCIONA BAJO PRESIÓN:	
Tradición de calidad e innovación con Payen®	XXXIV - XXXV
Certificado BER	XLII
Lista de referencias nuevas	XLIII
Lista de nuevos motores	XLIV
Aplicaciones por fabricante	2
Lista de referencias numéricas	294
Intercambio entre equipo original y Payen	300
Notas técnicas	312



Содержание	III
Payen: история и присутствие на мировом рынке	IV
Модели автомобилей, сортировка по производителю	V
Условия сотрудничества	VII
Новейшие каталоги Federal-Mogul по деталям двигателя и уплотнениям	VIII
Структура нумерации деталей Payen	IX
Как пользоваться каталогом	XVI - XVII
Руководство по установке прокладки головки блока цилиндров и болтов	XXIV
Эффективность под давлением:	
наследие качества и инноваций - Payen®	XXXVIII - XXXIX
Сертификат BER	XLII
Список новой продукции	XLIII
Список новых двигателей	XLIV
Модели автомобилей, сортировка по производителю	2
Список номеров деталей	294
Взаимозаменяемость OE → Payen	300
Технические примечания	312



Zawartość	III
Payen - historia i obecność na świecie	IV
Zastosowania w kolejności producentów	V
Warunki i wymagania sprzedaży	VII
Najnowsze katalogi Federal-Mogul dotyczące części silnikowych i uszczelnień	VIII
System oznaczania części Payen	IX
Jak korzystać z tego katalogu	XIV - XV
Poradnik montażowy uszczelek i śrub głowicowych	XXIII
PEWNOŚĆ W KAŻDYCH WARUNKACH:	
Efekt jakości i innowacyjności marki Payen®	XXXVI - XXXVII
Certyfikat BER	XLII
Lista nowych części	XLIII
Lista nowych silników	XLIV
Zastosowania w kolejności producentów	2
Numeryczna lista części	294
Lista zamienników z numerów OE na Payen	300
Notatki techniczne	312



المحتويات	III
تاريخ Payen وتواجدها العالمي	IV
التطبيقات حسب جهة التصنيع	V
بنود وشروط المبيعات	VII
أحدث كتالوجات Federal-Mogul للمحركات ومنتجات منع التسرب	VIII
نظام ترقيم قطع Payen	IX
كيفية استخدام هذا الكتالوج	XVI - XVII
دليل تركيب حشية رأس الأسطوانة والمسامير	XXV
جودة الأداء حتى في أصعب الظروف:	
تاريخ من الجودة والابتكار يتمثل في ماركة Payen®	XL - XLI
شهادة BER	XLII
قائمة القطع الجديدة	XLIII
قائمة محركات جديدة	XLIV
التطبيقات حسب جهة التصنيع	2
قائمة القطع المرقمة	294
تبدل المعدات الأصلية - Payen	300
ملاحظات فنية	312

PAYEN HISTORY

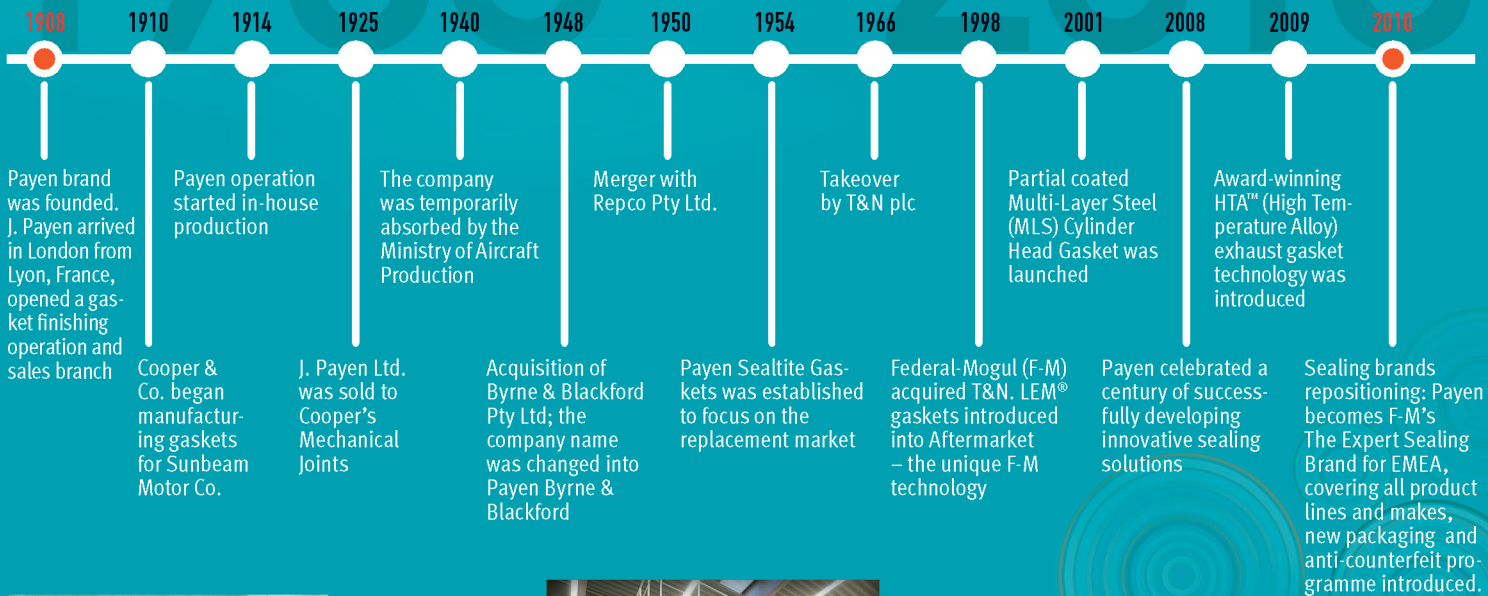

WORLDWIDE PRESENCE

PAYEN WORLDWIDE – BRINGING YOU GLOBAL EXPERTISE AND LOCAL KNOWLEDGE THROUGH WORLD CLASS PRODUCTS

PAYEN WELTWEIT – IN UNSEREN WELTKLASSEPRODUKTEN VEREINEN SICH GLOBALE FACHKENNTNIS UND LOKALE KOMPETENZ

PAYEN NEL MONDO – TUTTA LA CONOSCENZA E ESPERIENZA ATTRAVERSO PRODOTTI A DIFFUSIONE MONDIALE

PAYEN UNE PRÉSENCE MONDIALE – DES PRODUITS RÉPUTÉS DANS LE MONDE ENTIER, PORTÉS PAR UNE EXPERTISE MONDIALE ET DES SAVOIR-FAIRES LOCAUX

PAYEN POR TODO EL MUNDO – APORTANDO LA EXPERIENCIA GLOBAL Y EL CONOCIMIENTO LOCAL CON NUESTROS PRODUCTOS DE PRIMERA CLASE

PAYEN NA CAŁYM ŚWIECIE – DOSTARCZA CI ŚWIATOWĄ WIEDZĘ ORAZ ZNAJOMOŚĆ LOKALNYCH ZAGADNIEŃ OFERUJĄC PRODUKTY NA NAJWYŻSZYM ŚWIATOWYM POZIOMIE

PAYEN ВО ВСЕМ МИРЕ – ОБЕСПЕЧИВАЕМ ВАМ ГЛОБАЛЬНУЮ КОМПЕТЕНТНОСТЬ И ЛОКАЛЬНЫЕ ЗНАНИЯ ЧЕРЕЗ ПРОДУКТЫ МИРОВОГО КЛАССА

PAYEN العالمية – تزودك بالخبرة العالمية والمعرفة المحلية من خلال منتجات من الفئة العالمية



MANUFACTURERS LIST

Bedford	2
Cummins	4
DAF	6
Deutz/KHD	17
Fiat Commercial	24
Ford Commercial	38
Gardner	44
Hino	46
Isuzu	52
Iveco	54
Leyland	78
MAN	86
Mercedes-Benz	124
Mitsubishi	204
MWM	206
New Holland	208
Nissan	216
OM	218
Perkins	220
Renault Trucks/RVI	250
Scania	268
Volvo Commercial	282

TERMS OF BUSINESS

IMPORTANT



Reproduction of this catalogue or parts thereof is only allowed with our explicit permission in writing. Pictorial representations and design are copyrighted. Claims for damages, of any form whatsoever, resulting from details made in this catalogue or from incorrect use, application, storage or handling, are explicitly excluded. Contractual rights and any resulting or related claims based thereon, irrespective of form, initially come into being on the basis of a separate written agreement, in particular on the basis of our general terms of sale and delivery.

All former statements lose their validity with the publication of this catalogue.

The catalogue is not an operating manual for the use and installation of cylinder head gaskets, oil seals and cylinder headbolts. It does not contain any advice in a legal sense. The catalogue neither replaces the constantly applicable technical regulations – particularly for tolerances – nor the installation and maintenance stipulations of the individual engine manufacturer.

Also, it is not possible to forego the expertise of those carrying out the installation and application. The individual references made in this catalogue for the installation and the application of cylinder head gaskets, oil seals and cylinder headbolts are instructions solely for the technically qualified specialist and are to be checked and verified by them for their suitability in each case. Federal-Mogul accepts no responsibility for application decisions. The contents of the catalogue are not intended to create or substitute any contractual agreement which has to be reserved exclusively to a separate agreement between 2 identified parties, whereby seller can be only one of our Federal-Mogul entities as mentioned on the inside back cover.

The right is retained to correct errors and alterations, particularly with regard to amendments in the engine manufacturers' details and stipulations.

ZUR BEACHTUNG



Die Reproduktion dieses Katalogs ist nur mit unserer ausdrücklichen Genehmigung gestattet. Bildliche Darstellungen und der Entwurf sind urheberrechtlich geschützt. Schadenersatzansprüche in jedweder Form unter Berufung auf die Angaben in diesem Katalog oder infolge unsachgemäßen Gebrauchs, unsachgemäßer Anwendung, Lagerung oder Handhabung sind ausdrücklich ausgeschlossen. Vertragliche Rechte und etwaige hieraus folgende oder abgeleitete Ansprüche jedweder Art werden erst durch getrennte schriftliche Vereinbarung, im Besonderen auf der Grundlage unserer allgemeinen Verkaufs- und Lieferbedingungen, begründet. Mit Erscheinen dieses Katalogs verlieren alle früheren Angaben ihre Gültigkeit.

Der Katalog stellt keine Anleitung für den Gebrauch und den Einbau von Zylinderkopfdichtungen, Wellendichtringe und Zylinderkopfschrauben dar. Es werden keine Ratschläge im rechtlichen Sinne abgegeben. Der Katalog ersetzt weder die jeweils geltenden technischen Maßgaben – insbesondere für Toleranzen – noch die Einbau- und Wartungsvorschriften des jeweiligen Motorenherstellers. Auch ist die Sachkenntnis derer, die den Einbau und die Anwendung vornehmen, eine wesentliche Größe. Die Aussagen in diesem Katalog zum Einbau und Einsatz von Zylinderkopfdichtungen, Wellendichtringe und Zylinderkopfschrauben richten sich ausschließlich an den technisch versierten Fachmann und sind von Fall zu Fall auf Eignung und Gültigkeit zu überprüfen. Federal-Mogul übernimmt keine Verantwortung für Anwendungsentscheidungen.

Der Inhalt des Katalogs begründet oder ersetzt keine vertragliche Vereinbarung, welche ausschließlich einer getrennten Vereinbarung zwischen zwei bestimmten Parteien vorbehalten sein muss, in der die Verkäuferpartei eine unserer innen im Rückdeckel genannten Federal-Mogul Gesellschaften ist. Das Recht auf Berichtigung von Irrtümern und Abänderungen, insbesondere hinsichtlich geänderter Angaben und Bestimmungen der Motorenhersteller, bleibt vorbehalten.

IMPORTANTE



La riproduzione di questo catalogo, anche parziale, è permessa soltanto in seguito ad una autorizzazione scritta. I grafici ed i disegni sono a marchio depositato ed e depositato coperti da copyright. Reclami per difetti, di qualsiasi natura essi siano, relativi al contenuto di questo catalogo, o all'uso improprio, verranno respinti. Le pretese avanzate od i reclami dovranno essere in conformità con le nostre condizioni generali di vendita.

Il presente catalogo annulla e sostituisce tutte le edizioni precedenti.

Il catalogo non è un manuale per l'utilizzo ed il montaggio di guarnizioni testa cilindro, paraoli e viti testa. Non contiene indicazioni in questo senso. Esso non sostituisce le descrizioni tecniche, sempre prioritarie, in particolare per le tolleranze, ne' le istruzioni relative al montaggio ed alla manutenzione date dai costruttori dei rispettivi motori. Non può in nessun caso essere paragonato alla conoscenza professionale necessaria per il montaggio e l'utilizzo. Le considerazioni sul montaggio di guarnizioni testa cilindro, paraoli e viti testa, fatte su questo catalogo, sono destinate esclusivamente a professionisti con formazione tecnica i quali verificheranno l'esattezza delle informazioni, in ogni caso. Le responsabilità derivanti dall'utilizzo improprio dello stesso non potranno essere addebitate alla Federal-Mogul.

I contenuti del catalogo non sostituiscono in alcun modo gli accordi contrattuali che sono riservati esclusivamente a due contraenti definiti; come venditore si intende una delle società Federal-Mogul menzionate sul retro del catalogo.

Ci riserviamo il diritto di apportare correzioni e modifiche al contenuto del catalogo su istruzioni ricevute dal costruttore del motore.

IMPORTANT



La reproduction de ce catalogue, même partielle, n'est autorisée qu'avec notre accord préalable et par écrit. Les illustrations graphiques et la présentation font l'objet d'un copyright. Nous excluons toutes réclamations ayant pour objet ce catalogue ou pouvant résulter de son incompréhension, portant sur de mauvaises utilisations, manipulations, manutentions ou mauvais stockage. Des droits contractuels et des droits dérivés, de quelque nature qu'ils soient, ne peuvent résulter que d'un accord écrit, sur la base de nos conditions générales de ventes et de livraisons. Ce catalogue annule et remplace toute édition antérieure.

Le catalogue n'est pas une notice d'utilisation et de montage des joints de culasse, bagues d'étanchéité et vis de culasse. Il ne contient pas de directives en tant que telles. Le catalogue ne remplace ni les prescriptions techniques, toujours prioritaires, particulièrement pour les tolérances, ni les prescriptions de montage et d'entretien des fabricants des moteurs figurant dans ce catalogue. Il ne peut en aucun cas remplacer les connaissances professionnelles nécessaires pour le montage et l'utilisation des produits. Les remarques données pour le montage et l'utilisation des joints de culasse, bagues d'étanchéité et vis de culasse sont exclusivement destinées au professionnel averti et de formation technique, à qui il appartiendra de vérifier la conformité des indications pour chaque cas. La responsabilité quant aux décisions d'utilisation ne peut être prise en charge par Federal-Mogul.

Le contenu de ce catalogue ne peut constituer ou remplacer un contrat qui doit faire l'objet d'un document séparé établi entre 2 parties, dont l'une doit être une entité légale de Federal-Mogul (dont la liste figure sur la couverture arrière).

Nous nous réservons le droit d'apporter toutes corrections d'erreurs et modifications, suite notamment à de nouvelles données fournies par les constructeurs.

TERMS OF BUSINESS

IMPORTANTE



Queda totalmente prohibida la reproducción, total o parcial, del contenido de este catálogo, salvo previa autorización nuestra, realizada por escrito. Están, asimismo, reservados todos los derechos sobre el diseño y presentación del catálogo. No se aceptará ningún tipo de reclamación que esté basada en la interpretación de los datos contenidos en este catálogo, así como en el incorrecto uso, manipulación o almacenaje de nuestras piezas. Únicamente se aceptarán reclamaciones que estén basadas en derechos contractuales o en los motivos arriba indicados, siempre que exista un acuerdo especial y por escrito basado en nuestras condiciones generales de venta y suministro.

Con la edición de este catálogo queda anulada toda la información contenida en catálogos anteriores.

El catálogo no es un manual para el uso e instalación de las juntas de culata, retenes de aceite y tornillos de culata, y no representa una asesoría técnica en el sentido legal. Los datos del catálogo no sustituyen, en ningún caso, a las especificaciones técnicas, tanto en lo que se refiere a tolerancias como a las instrucciones de instalación y mantenimiento, indicadas por los fabricantes de los motores, especificaciones que serán siempre prioritarias. Se entiende que el uso y montaje de estas piezas está encomendado a personal debidamente cualificado. Las indicaciones sobre uso y montaje de las juntas de culata, retenes de aceite y tornillos de culata, contenidas en este catálogo, están exclusivamente dirigidas a profesionales con la debida capacitación y formación técnica, que deben decidir en cada caso sobre la exactitud de las mismas. La responsabilidad de estas decisiones no puede ser, en ningún caso atribuidas a Federal-Mogul.

La información facilitada en el catálogo no representa o sustituye ningún tipo de acuerdo, quedando a tal efecto, el acuerdo por separado entre dos partes donde sólo entidades de Federal-Mogul, pueden ser identificadas como la parte vendedora como se menciona en la contraportada.

Los datos e instrucciones contenidos en este catálogo podrán ser corregidos o modificados sin previo aviso.

WAŻNE



Reprodukcja tego katalogu lub jego części jest możliwa tylko za wyraźną zgodą na piśmie. Ilustracje i grafika są chronione prawem autorskim. Roszczenia dotyczące szkód, niezależnie od formy, wynikających z przedstawionych w tym katalogu treści lub z nieprawidłowego użycia, zastosowania, przechowywania lub obsługi są w sposób wyraźny wyłączone. Prawa umowne i inne wynikające lub związane z roszczeniami w nimi opartymi, niezależnie od formy, są tworzone na podstawie oddzielnej umowy pisemnej, w szczególności na podstawie naszych ogólnych warunków sprzedaży i dostawy.

Wszystkie wcześniejsze oświadczenia tracą ważność wraz z opublikowaniem tego katalogu.

Katalog nie jest instrukcją obsługi i instalacji uszczeltek głowicowych, uszczelnień olejowych i śrub głowicowych. Nie zawiera porad w sensie prawnym. Katalog nie zastępuje obowiązujących uregulowań technicznych – zwłaszcza w zakresie tolerancji – ani opisów montażu i konserwacji poszczególnych producentów silników.

Nie jest również możliwe pominięcie doświadczenia osób dokonujących doboru i przeprowadzających montaż części. Poszczególne odniesienia zawarte w tym katalogu, a dotyczące doboru, montażu i stosowania uszczeltek głowicowych, uszczelnień olejowych i śrub głowicowych, są instrukcjami wyłączone dla wykwalifikowanego technicznie specjalisty, który w każdym przypadku musi je sprawdzić i zweryfikować ich przydatność. Federal-Mogul nie przyjmuje odpowiedzialności za decyzje dotyczące zastosowania.

Zawartość tego katalogu nie stanowi ani nie zastępuje umowy, która może być zawarta jedynie jako oddzielny dokument podpisany przez dwie strony, przy czym sprzedawcą może być tylko jedna z jednostek koncernu Federal-Mogul, zgodnie z opisem na wewnętrznej stronie tylnej okładki.

Zachowane zostaje prawo korygowania błędów i wprowadzania zmian, zwłaszcza odnośnie zmian dotyczących parametrów i warunków pracy określonych przez producentów silników.

ВАЖНО



Воспроизводство данного каталога или ее частей позволено только с нашим явным разрешением в письменной форме. Иллюстрации и дизайн защищены авторским правом. Требования о возмещении ущерба, любой формы, исходя из содержания каталога или от неправильного использования, хранения или обращения, явно исключены. Договорные права и любые связанные требования базировались вслед за тем, независимо от формы, отдельного первоначально письменного соглашения, в особенности на основе наших общих условий продаж и поставок. Все прежние утверждения теряют свою юридическую силу с публикацией данного каталога.

Каталог не операционное руководство для использования и установки уплотнений, сальников и болтов головки блока цилиндра. Оно не содержит совета в юридическом смысле. Каталог не заменяет постоянно применимые технические инструкции – особенно при допусках – соглашения установки и обслуживания отдельного автопроизводителя. Кроме того, не возможно предсказать профессионализм тех, кто выполняют установку и ремонт.

Отдельные ссылки, сделанные в этом каталоге для установки и замены уплотнений, сальников и болтов головки блока цилиндра являются инструкциями исключительно для технически компетентного специалиста и должны быть проверены ими для их пригодности в каждом случае. Federal-Mogul не несет ответственность за ремонтные работы.

Содержание каталога не предназначено, чтобы создавать или заменять любые договорные соглашения, которое должны быть сохранены исключительно к отдельному соглашению между 2мя сторонами, посредством чего продавец может быть только одним из юридических лиц Federal-Mogul как упомянуто на странице обратной стороны.

Сохраняется право, исправлять ошибки и изменения, особенно относительно к поправкам по деталям изготовителей двигателя и их условиям.



لا يُسمح بنسخ هذا الدليل أو أي جزء منه إلا بتصريح كتابي صريح. جميع التمثيلات التصويرية والتصميمات محفوظة بموجب حقوق الطبع والنشر ولا تتحمل الشركة صراحة أي مطالبات بخسائر، أيًا كانت صورتها، تنشأ عن التفاصيل الواردة في هذا الدليل أو نتيجة لسوء الاستخدام أو التطبيق أو التخزين أو النقل. أي حقوق تعاقدية أو أي مطالبات لها علاقة بتلك الحقوق أو تنشأ تأسيسًا عليها، بغض النظر عن صورتها، تنشأ تأسيسًا على اتفاق كتابي منفصل، وبخاصة تأسيسًا على شروط البيع والتسليم الخاصة بنا. تفقد كل البيانات السابقة صلاحيتها بمجرد نشر هذا الدليل.

هذا الدليل ليس دليلًا للتشغيل لتوضيح استخدام وتركيب المكابس أو البطانة أو التجميع. كما لا يحتوي على أي نصيحة بالمعنى القانوني، ولا يحل هذا الدليل محل القواعد الفنية المطبقة باستمرار خاصة فيما يتعلق بالتحميل، كما لا يحل محل شروط التركيب والصيانة الخاصة بمصنعي المحركات الفردية.

كذلك لا يمكن الاستغناء عن خبرة الفنيين الذين يقومون بالتركيب أو التطبيق. وجميع الإشارات الواردة في هذا الدليل والتي تتعلق بتركيب وتطبيق المكابس والبطانة وعمليات التجميع هي إرشادات للمتخصصين الفنيين المؤهلين فحسب ويتم مراجعتها والتأكد من ملاءمتها في كل حالة على حده. ولا تتحمل شركة Federal-Mogul أي مسؤولية تتعلق بقرارات التطبيق.

ليس المقصود بمحتوى هذا الدليل أن يخلق أو يستبدل أي اتفاقات تعاقدية يتم الاحتفاظ بها حصريًا في اتفاقية منفصلة بين طرفين محددتين، والتي يمكن أن يكون بموجبها أحد الكيانات التابعة لشركة Federal-Mogul هو الطرف البائع كما هو موضح في الوجه الداخلي للغلاف الخارجي. وتحتفظ الشركة بحقوقها في تصحيح أي أخطاء وإجراء أي تعديلات وبخاصة فيما يتعلق بتعديل تفاصيل مصنع المحرك والأحكام المنصوص عليها.

© Federal-Mogul Corporation 2010

The contents of this publication are the copyright of Federal-Mogul Corporation. Unauthorised reproduction in whole or in part is expressly forbidden.



Payen is a trademark of Federal-Mogul Corporation



CHECK OUT OUR CATALOGUES



CATAE901



CATAE902



CATAE1101



CATGY901



CATGT1001



CATMX901



CATPA1001



CATPA1101



XCD11

YOU CAN OBTAIN THESE CATALOGUES THROUGH YOUR Federal-Mogul SALES REPRESENTATIVE OR THROUGH YOUR LOCAL DISTRIBUTOR

PAYEN PART NUMBERING STRUCTURE

2 LETTERS PREFIX for GASKETS and SEALS

3 LETTERS PREFIX for HEADBOLTS

AA – BZ CYLINDER HEAD GASKETS
CA – DZ HEAD SETS
EA – EZ CONVERSION SETS
FA – GZ FULL SETS



JM – JP VALVE COVER GASKETS
HM VALVE COVER SETS
PA – PB SINGLE VALVE STEM SEALS
HR VALVE STEM SEALS SETS



JH – JJ SUMP GASKETS
JA – JD MANIFOLD GASKETS
JE – JF EXHAUST PIPE JOINTS
JR – JS TIMING CASE GASKETS
KA WATER PUMP GASKETS
KK MISCELLANEOUS JOINTS
HA MANIFOLD SETS

HBS HEADBOLT SETS



NA – NZ DYNAMIC OIL SEALS
LK INTEGRATED SEAL and HOUSING
LC – KV MISCELLANEOUS SEALS
HL MISCELLANEOUS SETS

HL5xxx TIMING OIL SEAL SETS





HOW TO USE THIS CATALOGUE

MERCEDES-BENZ									
1	2	3	4	5	6	7			
Engine code	Engine info	Payen ref.	New parts	Cylinder head gasket	Head set	Full set			
cc	Ø	!	kW/PS						
46	OM 401.975/OM 401.976	9572	6	125.00	OM 401 LA/Euro 1/ Turbo Intercooled/V	180/245	AH5450 (Fibre) (x6)[274] BG850 (SE) (x6)	DG853 (x6) DG854 ○ (x6)	EX851
	OM 401.983/OM 401.984/ OM 401.990/OM 401.994	9572	6	125.00	OM 401 LA/Turbo Intercooled/V	180/245			
	OM 401.973	9572	6	125.00	OM 401 LA/Turbo Intercooled/V	200/272			
	OM 401.974/OM 401.977/	9572	6	125.00	OM 401 LA/Euro 1/	200/272			

- 1 Engine code
- 2 Engine information
- 3 Payen reference
- 4 New parts (highlighted in colour)

- 5 **CYLINDER HEAD GASKET**
 - ☐ = Left
 - ☒ = Right
 - ⊖ = Piston protrusion
 - 1.55mm = Thickness
 - 1 hole = Identification mark

- 6 **HEAD SET**
 - ▲ Without cylinder head gasket
 - Without seals
 - ☒ Without valve cover gasket
 - Without valve stem seals
- 7 **FULL SET
CONVERSION SET**
 - ▲ Without cylinder head gasket
 - Without seals
 - ☒ Without valve cover gasket
 - Without valve stem seals



HINWEISE ZUR BENUTZUNG DES KATALOGS

MERCEDES-BENZ									
1	2	3	4	5	6	7			
Motor-Nr.	Motor-Angaben	Payen Best.-Nr.	Neue Dichtungen	Zylinderkopfdichtung	Zylinderkopfdichtungssatz	Vollständiger Satz			
cc	Ø	!	kW/PS						
46	OM 401.975/OM 401.976	9572	6	125.00	OM 401 LA/Euro 1/ Turbo Intercooled/V	180/245	AH5450 (Fibre) (x6)[274] BG850 (SE) (x6)	DG853 (x6) DG854 ○ (x6)	EX851
	OM 401.983/OM 401.984/ OM 401.990/OM 401.994	9572	6	125.00	OM 401 LA/Turbo Intercooled/V	180/245			
	OM 401.973	9572	6	125.00	OM 401 LA/Turbo Intercooled/V	200/272			
	OM 401.974/OM 401.977/	9572	6	125.00	OM 401 LA/Euro 1/	200/272			

- 1 Motor-Nr.
- 2 Motor-Angaben
- 3 Payen Best.-Nr.
- 4 Neue Dichtungen
(Farbig hervorgehoben)

- 5 **ZYLINDERKOPFDICHTUNG**
 - ☐ = Links
 - ☒ = Rechts
 - ⊖ = Kolbenüberstand
 - 1.55mm = Dicke
 - 1 Loch = Identifizierungs-Hinweis

- 6 **ZYLINDERKOPFDICHTUNGSSATZ**
 - ▲ Ohne Zylinderkopfdichtung
 - Ohne Wellendichtringe
 - ☒ Ohne Ventildeckeldichtung
 - Ohne Ventilschaftdichtungen
- 7 **VOLLSTÄNDIGER SATZ
KURBELGEHÄUSESATZ**
 - ▲ Ohne Zylinderkopfdichtung
 - Ohne Wellendichtringe
 - ☒ Ohne Ventildeckeldichtung
 - Ohne Ventilschaftdichtungen

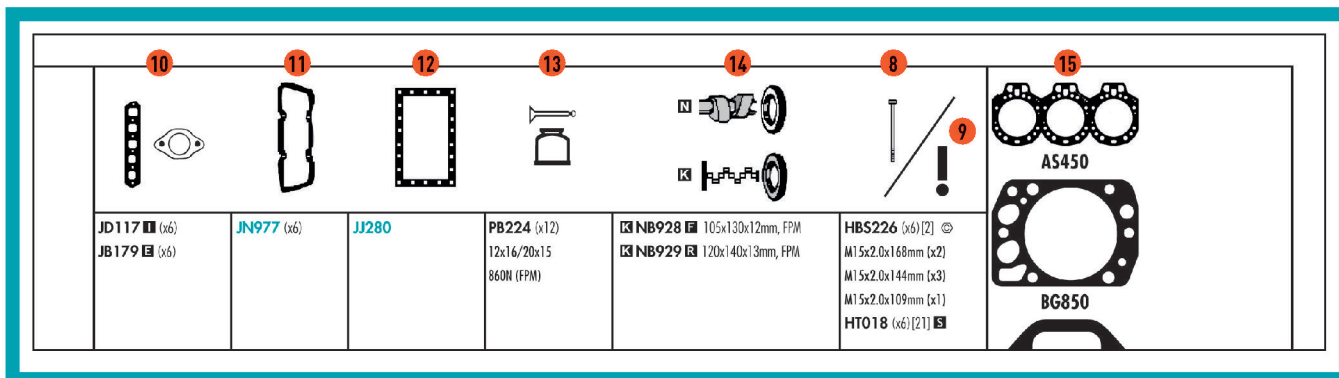

8 = HEADBOLT SET
 = HEADBOLT SHAPE

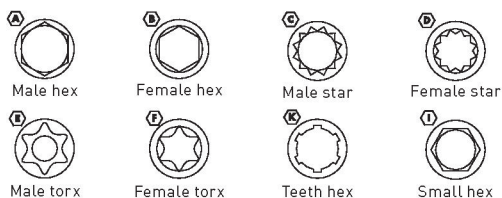

9 MISCELLANEOUS GASKET/SEALS

- Front = F
 Rear = R
 Inner = X
 Outer = D
 [86] = Technical note

10 MANIFOLD GASKET

- Left = K
 Right = P
 Set = S
 Inlet = I
 Exhaust = E
 Upper = A
 Lower = V
 = EXHAUST PIPE GASKET

11 VALVE COVER GASKET

- Left = K
 Right = P
 Inlet = I
 Exhaust = E

12 SUMP GASKET

- Set = S
 [57] = Technical note

13 VALVE STEM SEAL

- Set = S
 Inlet = I
 Exhaust = E

14 OIL SEALS

- Front = F
 Rear = R
 Camshaft seal = N
 Crankshaft seal = K

15 SHADOWGRAPH

HINWEISE ZUR BENUTZUNG DES KATALOGS

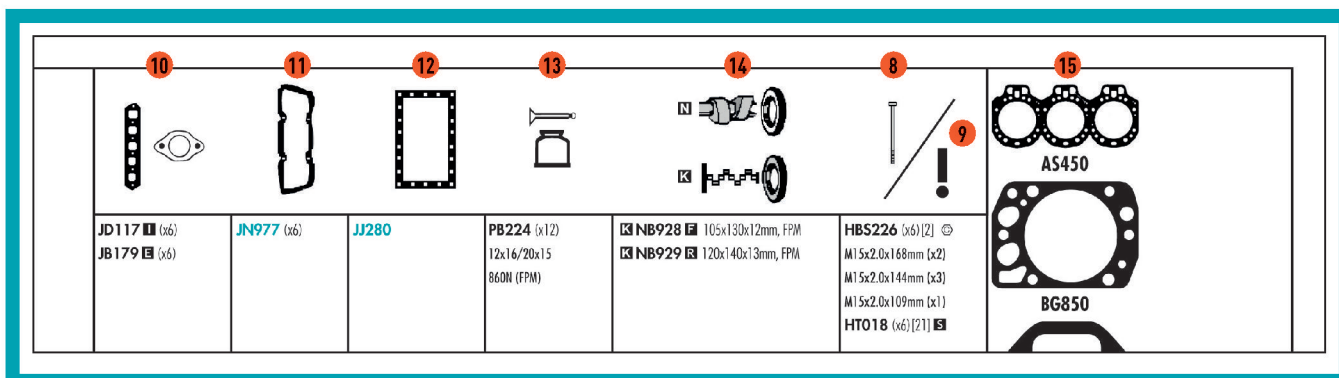

8 = ZYLINDERKOPFSCHRAUBEN-SATZ
 = ZYLINDERKOPF-SCHRAUBEN-FORM



9 VERSCHIEDENE DICHTUNGEN/DICHRINGE

- Vorn = F
 Hinten = R
 Innen = X
 Außen = D
 [86] = Technischer Hinweis

10 ANSAUGKRÜMMER-DICHTUNG

- Links = K
 Rechts = P
 Satz = S
 Einlass = I
 Auslass = E
 Obere = A
 Untere = V
 = AUSPUFF-KRÜMMERDICHTUNG

13 VENTILSCHACHTDICHTUNG

11 VENTILDECKELDICHTUNG

- Links = K
 Rechts = P
 Einlass = I
 Auslass = E

12 ÖLWANNENDICHTUNG

- Satz = S
 [57] = Technischer Hinweis

14 ÖLDICHTUNGEN

- Links = K
 Rechts = P
 Einlass = I
 Auslass = E

14 ÖLDICHTUNGEN

- Vorn = F
 Hinten = R
 Nockenwellendichtring = N
 Kurbelwellendichtring = K

15 PHANTOMZEICHNUNG

COME UTILIZZARE IL CATALOGO

MERCEDES-BENZ									
1	2	3	4	5	6	7			
	cc			kW/PS					
46	OM 401.975/OM 401.976	9572	6	125.00	OM 401 LA/Euro 1/ Turbo Intercooled/V	180/245	AH5450 (Fibre) (x6)[274]	DG853 (x6)	
	OM 401.983/OM 401.984/ OM 401.990/OM 401.994	9572	6	125.00	OM 401 LA/Turbo Intercooled/V	180/245	BG850 (SE) (x6)	DG854 (x6)	
	OM 401.973	9572	6	125.00	OM 401 LA/Turbo Intercooled/V	200/272			
	OM 401.974/OM 401.977/	9572	6	125.00	OM 401 LA/Euro 1/	200/272			

- 1 Codice motore
- 2 Informazioni sul motore
- 3 Riferimento Payen
- 4 Nuovi articoli (evidenziati con colore)

- 5 **GUARNIZIONE TESTA CILINDRO**
 - = Sinistra
 - = Destra
 - = Sporgenza pistone al PMS
 - 1.55mm = Spessore
 - 1 foro = Segno di identificazione

- 6 **SERIE SMERIGLIO**
 - ▲ Senza guarnizione testa cilindro
 - Senza paraoli
 - ☒ Senza guarnizione coperchio valvola
 - Senza paraoli gambo valvola
- 7 **SERIE MOTORE COMPLETA**
SERIE COMPLEMENTARE
 - ▲ Senza guarnizione testa cilindro
 - Senza paraoli
 - ☒ Senza guarnizione coperchio valvola
 - Senza paraoli gambo valvola













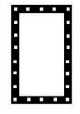

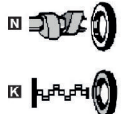
COMMENT UTILISER CE CATALOGUE

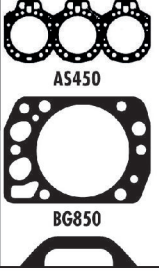
MERCEDES-BENZ									
1	2	3	4	5	6	7			
	cc			kW/PS					
46	OM 401.975/OM 401.976	9572	6	125.00	OM 401 LA/Euro 1/ Turbo Intercooled/V	180/245	AH5450 (Fibre) (x6)[274]	DG853 (x6)	
	OM 401.983/OM 401.984/ OM 401.990/OM 401.994	9572	6	125.00	OM 401 LA/Turbo Intercooled/V	180/245	BG850 (SE) (x6)	DG854 (x6)	
	OM 401.973	9572	6	125.00	OM 401 LA/Turbo Intercooled/V	200/272			
	OM 401.974/OM 401.977/	9572	6	125.00	OM 401 LA/Euro 1/	200/272			

- 1 Code moteur
- 2 Identification moteur
- 3 Référence Payen
- 4 Nouveaux produits (surlignés)

- 5 **JOINT DE CULASSE**
 - = Gauche
 - = Droit
 - = Piston protrusion
 - 1.55mm = Epaisseur
 - 1 trou = marque d'identification

- 6 **POCHETTE RODAGE**
 - ▲ Joint de culasse non inclus
 - Bagues d'étanchéité non incluses
 - ☒ Joint de couvre-culbuteurs non inclus
 - Joints de queue de soupape non inclus
- 7 **POCHETTE COMPLÈTE**
POCHETTE COMPLÉMENT
 - ▲ Joint de culasse non inclus
 - Bagues d'étanchéité non incluses
 - ☒ Joint de couvre-culbuteurs non inclus
 - Joints de queue de soupape non inclus

10	11	12	13	14	8	15
						
JD117  (x6) JB179  (x6)	JN977 (x6)	JJ280	PB224 (x12) 12x16/20x15 860N (FPM)	 NB928  105x130x12mm, FPM  NB929  120x140x13mm, FPA	HBS226 (x6) [2]  M1 5x2.0x168mm (x2) M1 5x2.0x144mm (x3) M1 5x2.0x109mm (x1) HTO18 (x6) [21] 	AS450 BG850

8  = **SERIE BULLONI TESTA**

 = **FORMA VITI TESTA**

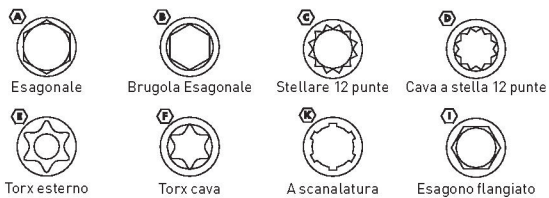

9 **TENUTE/GUARNIZIONI VARIE**

- Anteriore = **F**
- Posteriore = **R**
- Interna = **X**
- Esterna = **K**
- [86] = Nota tecnica

10 **GUARNIZIONE COLLETTORE**

- Sinistro = **K**
- Destro = **P**
- Serie = **S**
- Aspirazione = **I**
- Scarico = **E**
- Superiore = **A**
- Inferiore = **M**

 = **GUARNIZIONE TUBO DI SCAPPAMENTO**

11 **GUARNIZIONE COPERCHIO VALVOLA**

- Sinistro = **K**
- Destro = **P**
- Aspirazione = **I**
- Scarico = **E**

12 **GUARNIZIONE COPPA**

- Serie = **S**
- [57] = Nota tecnica

13 **PARAOLIO GAMBO VALVOLA**













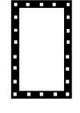

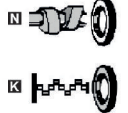
- Serie = **S**
- Aspirazione = **I**
- Scarico = **E**

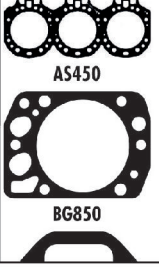
14 **PARAOILI**

- Anteriore = **F**
- Posteriore = **R**
- Paraolio albero a camme = **N**
- Paraolio albero motore = **K**

15 **TENUTE/GUARNIZIONI VARIE**

- Anteriore = **F**
- Posteriore = **R**
- Interna = **X**
- Esterna = **K**
- [86] = Nota tecnica

10	11	12	13	14	8	15
						
JD117  (x6) JB179  (x6)	JN977 (x6)	JJ280	PB224 (x12) 12x16/20x15 860N (FPM)	 NB928  105x130x12mm, FPM  NB929  120x140x13mm, FPA	HBS226 (x6) [2]  M1 5x2.0x168mm (x2) M1 5x2.0x144mm (x3) M1 5x2.0x109mm (x1) HTO18 (x6) [21] 	AS450 BG850

8  = **POCHETTE DE VIS DE CULASSE**

 = **FORME DE LA VIS DE CULASSE**

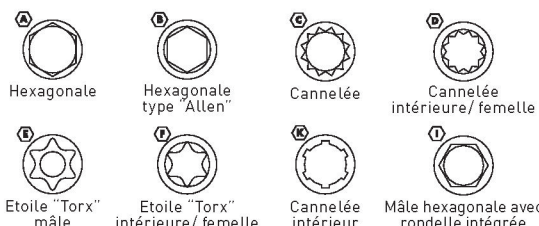

9 **JOINTS/ BAGUES DIVERS**

- Avant = **F**
- Arrière = **R**
- Intérieur = **X**
- Extérieur = **K**
- [86] = Note technique

10 **JOINT DE COLLECTEUR**

- Gauche = **K**
- Droit = **P**
- Pochette = **S**
- Admission = **I**
- Échappement = **E**
- Supérieur = **A**
- Inferieur = **M**

 = **BRIDE D'ÉCHAPPEMENT**

11 **JOINT DE COUVRE-CULBUTEURS**

- Gauche = **K**
- Droit = **P**
- Admission = **I**
- Échappement = **E**

12 **JOINT DE CARTER D'HUILE**

- Pochette = **S**
- [57] = Note technique

13 **JOINT DE QUEUE DE SOUPAPE**

- Pochette = **S**
- Admission = **I**
- Échappement = **E**

14 **BAGUES D'ÉTANCHÉITÉ**

- Avant = **F**
- Arrière = **R**
- Bagues d'étanchéité d'arbre à cames = **N**
- Bagues d'étanchéité de vilebrequin = **K**

15 **SILHOUETTE**



CÓMO USAR ESTE CATÁLOGO

MERCEDÉS-BENZ									
1	2	3	4	5	6	7			
	cc			kW/PS					
46	OM 401.975/OM 401.976	9572	6	125.00	OM 401 LA/Euro 1/ Turbo Intercooled/V	180/245	AH5450 (Fibra) (x6)[274]	DG853 (x6)	EX851
	OM 401.983/OM 401.984/ OM 401.990/OM 401.994	9572	6	125.00	OM 401 LA/Turbo Intercooled/V	180/245	BG850 (SE) (x6)	DG854 (x6)	
	OM 401.973	9572	6	125.00	OM 401 LA/Turbo Intercooled/V	200/272			
	OM 401.974/OM 401.977/	9572	6	125.00	OM 401 LA/Euro 1/	200/272			

- 1 Código del motor
- 2 Información sobre el motor
- 3 Referencia de Payen
- 4 Nuevas referencias (resaltado en color)

- 5 **JUNTA DE CULATA**
 - = Izquierda
 - = Derecha
 - = Resalte del pistón
 - 1.55mm = Espesor de la junta
 - 1 hole = N° de muescas

- 6 **JUEGO PARTE ALTA**
 - ▲ Sin junta de culata
 - Sin retenes
 - ☒ Sin junta de tapa de válvulas
 - Sin retenes de válvula
- 7 **JUEGO COMPLETO**
JUEGO DE PARTE BAJA
 - ▲ Sin junta de culata
 - Sin retenes
 - ☒ Sin junta de tapa de válvulas
 - Sin retenes de válvula









JAK UŻYWAĆ TEGO KATALOGU

MERCEDÉS-BENZ									
1	2	3	4	5	6	7			
	cc			kW/PS					
46	OM 401.975/OM 401.976	9572	6	125.00	OM 401 LA/Euro 1/ Turbo Intercooled/V	180/245	AH5450 (Fibra) (x6)[274]	DG853 (x6)	EX851
	OM 401.983/OM 401.984/ OM 401.990/OM 401.994	9572	6	125.00	OM 401 LA/Turbo Intercooled/V	180/245	BG850 (SE) (x6)	DG854 (x6)	
	OM 401.973	9572	6	125.00	OM 401 LA/Turbo Intercooled/V	200/272			
	OM 401.974/OM 401.977/	9572	6	125.00	OM 401 LA/Euro 1/	200/272			

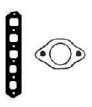
- 1 Kod silnika
- 2 Informacja o silniku
- 3 Numer referencyjny Payen (wyróżnione kolorem)
- 4 Nowe części

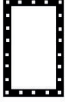
- 5 **USZCZELKA PODGŁOWICOWA**
 - = Lewy
 - = Prawy
 - = Wysunięcie tłoka
 - 1.55 mm = Grubość
 - 1 otwór = Znak identyfikujący

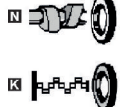
- 6 **ZESTAW GŁOWICOWY - GÓRA SILNIKA**
 - ▲ Bez uszczelki podgłowicowej
 - Bez uszczelnień
 - ☒ Bez uszczelki pokrywy zaworów
 - Bez uszczelnień trzonka zaworu
- 7 **ZESTAW KOMPLETNY**
ZESTAW USZCZELEK - DÓŁ SILNIKA
 - ▲ Bez uszczelki podgłowicowej
 - Bez uszczelnień
 - ☒ Bez uszczelki pokrywy zaworów
 - Bez uszczelnień trzonka zaworu

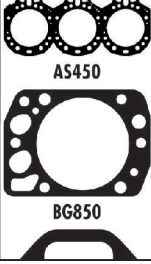
10	11	12	13	14	8	15
						
JD117 (x6) JB179 (x6)	JN977 (x6)	JJ280	PB224 (x12) 12x16/20x15 860N (FPM)	▣ NB928 (x6) 105x130x12mm, FPM ▣ NB929 (x6) 120x140x13mm, FPM	HBS226 (x6) [2] ⊕ M1.5x2.0x168mm (x2) M1.5x2.0x144mm (x3) M1.5x2.0x109mm (x1) HTO18 (x6) [21] ⊕	AS450 BG850

8 | = JUEGO DE TORNILLOS

⊕ = TIPOS FORMA CABEZA DE TORNILLOS

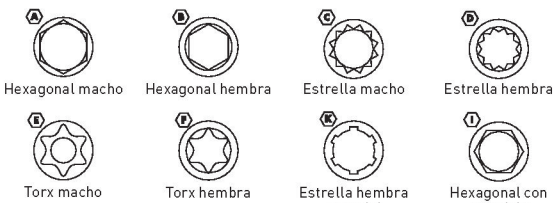

9 OTRAS JUNTAS Y RETENES

- Delantero = **F**
- Trasero = **R**
- Interior = **X**
- Exterior = **K**
- [86] = Nota técnica

10 JUNTA DEL COLECTOR DE ESCAPE

- Izquierda = **K**
- Derecha = **P**
- Conjunto = **S**
- Admisión = **I**
- Escape = **E**
- Superior = **▲**
- Inferior = **▼**

 = JUNTA DEL COLECTOR DE ADMISIÓN

11 JUNTA DE TAPA DE VÁLVULAS

- Izquierda = **K**
- Derecha = **P**
- Admisión = **I**
- Escape = **E**

12 JUNTA DEL CÁRTER

- Conjunto = **S**
- [57] = Nota técnica







13 RETÉN DE VÁLVULA

- Conjunto = **S**
- Admisión = **I**
- Escape = **E**

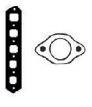
14 RETENES DE ACEITE

- Delantero = **F**
- Trasero = **R**
- Reten Árbol de Levas = **N**
- Reten de Cigüeñal = **K**

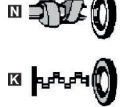
15 GRÁFICO SOBREADO

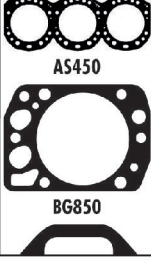
10	11	12	13	14	8	15
						
JD117 (x6) JB179 (x6)	JN977 (x6)	JJ280	PB224 (x12) 12x16/20x15 860N (FPM)	▣ NB928 (x6) 105x130x12mm, FPM ▣ NB929 (x6) 120x140x13mm, FPM	HBS226 (x6) [2] ⊕ M1.5x2.0x168mm (x2) M1.5x2.0x144mm (x3) M1.5x2.0x109mm (x1) HTO18 (x6) [21] ⊕	AS450 BG850

8 | = ZESTAW ŚRUB GŁOWICOWYCH

⊕ = KSZTAŁT ŁBÓW ŚRUB GŁOWICOWYCH



9 USZCZELKI/USZCZELNIENIA RÓŻNE

- Przedni = **F**
- Tylny = **R**
- Wewnętrzny = **X**
- Zewnętrzny = **K**
- [86] = Uwaga techniczna

10 USZCZELKA KOLEKTORA

- Lewy = **K**
- Prawy = **P**
- Komplet = **S**
- Dolotowy = **I**
- Wylotowy = **E**
- Górny = **▲**
- Dolny = **▼**

 = USZCZELKA RURY WYDECHOWEJ

11 USZCZELKA POKRYWY ZAWOROWEJ

- Lewy = **K**
- Prawy = **P**
- Dolotowy = **I**
- Wylotowy = **E**

12 USZCZELKA MISKI OLEJOWEJ

- Komplet = **S**
- [57] = Uwaga techniczna

13 USZCZELNIENIE TRZONKA ZAWORU

- Komplet = **S**
- Dolotowy = **I**
- Wylotowy = **E**

14 USZCZELNIENIA OLEJOWE

- Przedni = **F**
- Tylny = **R**
- Uszczelnienie wałka rozrządu = **N**
- Uszczelnienie wiatu korbowego = **K**

15 RYSUNEK



КАК ПОЛЬЗОВАТЬСЯ КАТАЛОГОМ

MERCEDES-BENZ										
1	2	3	4	5	6	7				
№ двигателя	Информация о двигателе	Код Рауен	Новые позиции в ассортименте (отмеченный цветом)	ПРОКЛАДКА ГОЛОВКИ БЛОКА ЦИЛИНДРОВ	КОМПЛЕКТЫ ГОЛОВКИ БЛОКА ЦИЛИНДРОВ	ПОЛНЫЙ КОМПЛЕКТ КОМПЛЕКТ БЛОКА ЦИЛИНДРОВ				
46	OM 401.975/OM 401.976	9572	6	125.00	OM 401 LA/Euro 1/ Turbo Intercooled/V	180/245	AH5450 (Fibra) (x6) [274]	DG853 (x6)	EX851	
	OM 401.983/OM 401.984/ OM 401.990/OM 401.994	9572	6	125.00	OM 401 LA/Turbo Intercooled/V	180/245	BG850 (SE) (x6)	DG854 (x6)		
	OM 401.973	9572	6	125.00	OM 401 LA/Turbo Intercooled/V	200/272				
	OM 401.974/OM 401.977/	9572	6	125.00	OM 401 LA/Euro 1/	200/272				

1 Номер двигателя

2 Информация о двигателе

3 Код Рауен

4 Новые позиции в ассортименте (отмеченный цветом)

5 ПРОКЛАДКА ГОЛОВКИ БЛОКА ЦИЛИНДРОВ

◀ = левая

▶ = правая

⊞ = выступ поршня

1.5 мм = Толщина

1 отверстие = Идентификационный знак

6 КОМПЛЕКТЫ ГОЛОВКИ БЛОКА ЦИЛИНДРОВ

▲ Без прокладки головки блока цилиндров

■ Без сальников

☒ Без прокладки крышки клапанного механизма

● Без сальников клапанов

7 ПОЛНЫЙ КОМПЛЕКТ

КОМПЛЕКТ БЛОКА ЦИЛИНДРОВ

▲ Без прокладки головки блока цилиндров

■ Без сальников

☒ Без прокладки крышки клапанного механизма

● Без сальников клапанов



كيفية استخدام هذا الكتالوج

10	11	12	13	14	8	15
JD117 (x6) JB179 (x6)	JN977 (x6)	JJ280	PB224 (x12) 12x16/20x15 860N (FPM)	<input checked="" type="checkbox"/> NB928 <input type="checkbox"/> 105x130x12mm, FPM <input checked="" type="checkbox"/> NB929 <input type="checkbox"/> 120x140x13mm, FPM	HBS226 (x6) [2] ⊕ M1 5x2.0x168mm (x2) M1 5x2.0x144mm (x3) M1 5x2.0x109mm (x1) HT018 (x6) [27] ⊞	AS450 BG850

14 سدادات الزيت

F = أمامية
R = خلفية
N = سداد عمود الكامنة
K = سداد عمود الكرنك

15 صورة شعاعية

11 حشية غطاء الصمام

◀ = يسرى
▶ = اليمنى
I = السحب
E = العادم

12 حشية الحوض

S = المجموعة
= [57] المذكرة التقنية

13 سدادة ساق الصمام

S = المجموعة
I = السحب
E = العادم

10 حشية المجمع

◀ = اليسرى
▶ = اليمنى
S = المجموعة
I = السحب
E = العادم
▲ = العلوية
▼ = السفلية

= حشية أنبوب العادم

8 = مجموعة مسمار الراس

⊞ = شكل مسمار الراس

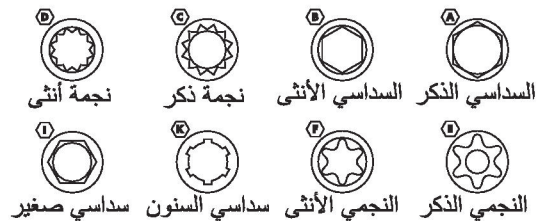

9 الحشيات / السدادات

المتنوعة

F = أمامية
R = خلفية
⊞ = داخلية
⊞ = خارجية
= [86] المذكرة التقنية



10	11	12	13	14	8	15
JD117 (x6) JB179 (x6)	JN977 (x6)	JJ280	PB224 (x12) 12x16/20x15 860N (FPM)	NB928 105x130x12mm, FPM NB929 120x140x13mm, FPM	HBS226 (x6) [2] ⊕ M1.5x2.0x168mm (x2) M1.5x2.0x144mm (x3) M1.5x2.0x109mm (x1) HTO18 (x6) [21] S	AS450 BG850

8 | = НАБОР БОЛТОВ
⊕ = ФОРМА ГОЛОВКИ БОЛТА



9 ПРОЧИЕ ПРОКЛАДКИ/УПЛОТНЕНИЯ

- Передние = F
- Задние = R
- Внутренние = X
- Наружные = K
- [86] = Техническое примечание

10 ПРОКЛАДКА КОЛЛЕКТОРА

- Левая = K
- Правая = P
- Комплект = S
- Впуск = I
- Выпуск = E
- Верхний = A
- Нижний = B

= ПРОКЛАДКА ВЫПУСКНОЙ ТРУБЫ

11 ПРОКЛАДКА КРЫШКИ КЛАПАННОГО МЕХАНИЗМА

- Левая = K
- Правая = P
- Впуск = I
- Выпуск = E

12 ПРОКЛАДКА ПОДДОНА КАРТЕРА

- Комплект = S
- [57] = Техническое примечание

13 САЛЬНИКИ КЛАПАНОВ

- Комплект = S
- Впуск = I
- Выпуск = E

14 САЛЬНИКИ ВАЛОВ

- Передние = F
- Задние = R
- Уплотнения распределительного вала = N
- Уплотнения коленчатого вала = K

15 ОЧЕРТАНИЕ

كيفية استخدام هذا الكتالوج



MERCEDES-BENZ									
1	2	3	4	5	6	7			
	cc		kW/PS						
46	OM 401.975/OM 401.976	9572	6	125.00	OM 401 LA/Euro 1/ Turbo Intercooled/V	180/245	AH5450 (Fibre) (x6) [27/4] BG850 (SE) (x6)	DG853 (x6) DG854 (x6)	EX851
	OM 401.983/OM 401.984/ OM 401.990/OM 401.994	9572	6	125.00	OM 401 LA/Turbo Intercooled/V	180/245			
	OM 401.973	9572	6	125.00	OM 401 LA/Turbo Intercooled/V	200/272			
	OM 401.974/OM 401.977/	9572	6	125.00	OM 401 LA/Euro 1/	200/272			

- 6** مجموعة الرأس
- ▲ بدون حشية رأس الأسطوانة
 - بدون السدادات
 - ☒ بدون حشية غطاء الصمام
 - بدون سدادات ساق الصمام

- 7** المجموعة الكاملة
- مجموعة التحويل
- ▲ بدون حشية رأس الأسطوانة
 - بدون السدادات
 - ☒ بدون حشية غطاء الصمام
 - بدون سدادات ساق الصمام

- 5** حشية رأس الأسطوانة
- ☒ يسرى
 - ☒ يمنى
 - ☒ بروز الكباس
 - ☒ سماكة = 1.55mm
 - ☒ تحديد علامة = 1 hole

- 1** المحرك
- 2** معلومات المحرك
- 3** رقم اللوحة
- 4** القطع الجديدة أبرزت في الألوان

STEP-BY-STEP INSTALLATION GUIDE

CYLINDER HEAD GASKET REPLACEMENT

1. Ensure both the head and block surfaces are clean and free from dirt, oil, coolant and old gasket material. Any debris on the surfaces could give rise to a leak path resulting in a failure of the new gasket. Avoid placing cleaned heads face down on the workbench or floor where fresh debris could be picked up.

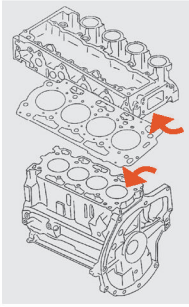

2. Take utmost care not to damage head and block surfaces if using a scraper to remove the old gasket. This is especially important with aluminium surfaces that are more easily damaged.

3. Ensure both head and block surface distortion is less than 0.05mm and that the surface finish is in line with the engine manufacturer's recommendations.

4. Ensure that all bolt-holes are clean from debris, coolant and oil. Avoid excessive use of lubricant especially in blind bolt-holes. This could result in a hydraulic lock adversely affecting the clamp load generated or even cracking the block.

5. For diesel engines check the piston height above the block to ensure that the correct gasket thickness is used.

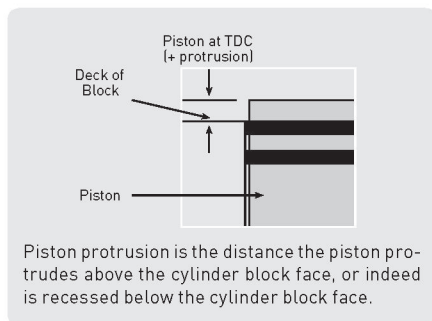

Protrusion + top of piston crown above the cylinder block face
Protrusion - Top of piston crown below the cylinder block face
 Both measured when piston is at TDC (top dead centre)

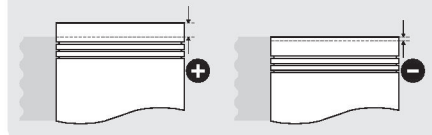

6. Avoid any form of additional sealant on a cylinder head gasket. This could lead to gasket extrusion and failure - plus it could be squeezed into the oil feed holes causing a blockage and consequent engine failure. However, there can be discrete areas where the engine manufacturer may advise the use of a sealant such as front cover 'T' joints.

7. Ensure that the gasket is fitted the right way up and correctly located on the engine and, where relevant, located on dowels prior to fitting the cylinder head.

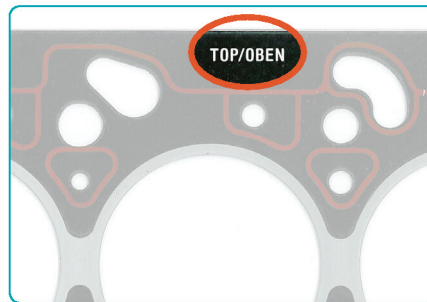

8. Inspect all head bolts for damage, length and cleanliness. If the engine uses stretch bolts (Torque-to-Yield), then use new bolts as recommended by the engine manufacturer.

9. Lightly oil the bolt threads and the bolt head undersides. Hand-tighten all bolts ensuring the correct bolt position when different bolt lengths are present. Torque the head bolts in the sequence recommended by the engine manufacturer. Use an angle indicator where required to ensure accuracy.

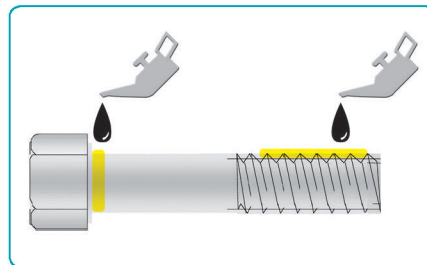

10. Where a retorque is recommended run the engine for 20 minutes. (Engines with aluminium cylinder heads should be allowed to cool to room temperature prior to a retorque).

CYLINDER HEAD BOLT TIGHTENING TIPS

- Inspect bolts and holes for cleanliness, damage and correct length/depth.
- Ensure blind holes are free of debris.
- Replace stretch bolts in accordance with the engine manufacturer's guidelines.
- Avoid excessive use of lubricant, sealant or adhesive on bolt threads and "blind" bolt-holes to alleviate the possibility of hydraulic lock and incorrect torque.
- Ensure that the joint surfaces are clean and free of oil.
- Torque the bolts using the recommended sequence.
- Stop pulling the torque wrench when it clicks!
- Use a degree wheel when required.
- Calibrate the torque wrench regularly - especially after it has been dropped!

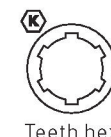
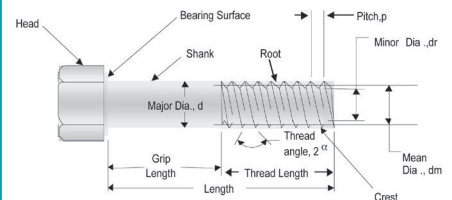

ZYLINDERKOPFDICHTUNG - AUS-/EINBAU

1. Sicherstellen, dass die Auflageflächen von Zylinderkopf und Motorblock frei von Schmutz, Öl, Kühlmittel und alten Dichtungsresten sind. Jede Verunreinigung auf den Auflageflächen kann einen Leckkanal bilden, wodurch die neue Dichtung ihre Funktion verliert. Den Zylinderkopf nicht mit der gereinigten Dichtfläche nach unten auf die Werkbank oder den Boden legen, wo neuer Schutz auf die Dichtfläche gelangen könnte.

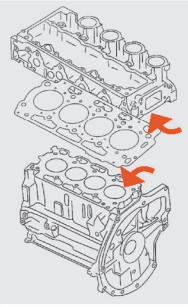

2. Bei Anwendung eines Schabers zum Entfernen von Dichtungsresten mit größter Vorsicht arbeiten, damit die Flächen von Zylinderkopf und Motorblock nicht beschädigt werden. Dies ist besonders wichtig bei Aluminiumflächen, die leichter beschädigt werden.

3. Sicherstellen, dass die Ungeradheit der Auflageflächen von Zylinderkopf und Motor nicht mehr als 0,05 mm beträgt und der Oberflächenzustand den Vorschriften des Motorenherstellers entspricht.

4. Alle Schraubenlöcher müssen frei von Schmutz, Kühlmittel und Öl sein. Übermäßige Anwendung von Schmiermittel, besonders in Sacklöchern, vermeiden. Andernfalls kann es zum einem hydraulischen Verschluss kommen, der die erzeugte Spannkraft herabsetzt oder sogar einen Riss im Motorblock verursacht.

5. Bei Dieselmotoren durch Kontrolle des Kolbenüberstands am Motorblock sicherstellen, dass die Dichtung die vorgeschriebene Dicke hat.

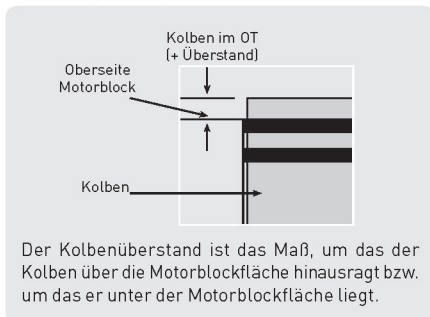

Überstand + Oberseite des Kolbenbodens oberhalb der Motorblockfläche
Überstand - Oberseite des Kolbenbodens unterhalb der Motorblockfläche
 In beiden Fällen wird bei OT-Stellung des Kolbens gemessen

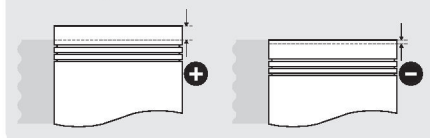

6. Niemals Dichtungsmittel bei einer Zylinderkopfdichtung verwenden! Dies könnte zu einer Ausweitung und einem Ausfall der Dichtung führen - und außerdem kann es in Ölbohrungen eindringen und den Ölfluss blockieren, was in einem Motorschaden resultiert. Es kann jedoch einzelne Stellen geben, für die der Motorenhersteller die Anwendung eines Dichtungsmittels empfiehlt, z. B. an 'T-Fugen' im vorderen Deckelbereich.

7. Die Dichtung mit der vorschriftsmäßigen Einbaurichtung und in der vorschriftsmäßigen Lage auf den Passstiften des Motorblockes auflegen.

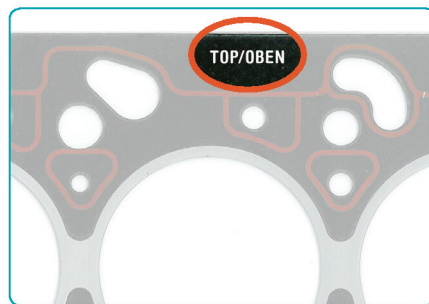

8. Alle Zylinderkopfschrauben auf Schäden, Länge und Sauberkeit kontrollieren. Wenn der Motor mit Dehnschrauben (Anziehen bis zur Streckgrenze) ausgestattet ist, neue Schrauben gemäß Empfehlung des Motorenherstellers verwenden.

9. Die Gewinde und die Unterseiten des Schraubenkopfes anölen. Alle Schrauben unter Beachtung der Schraubenposition, wenn unterschiedliche Längen vorkommen, von Hand anziehen. Die Zylinderkopfschrauben in der vom Motorenhersteller empfohlenen Reihenfolge anziehen. Falls erforderlich für die Genauigkeit einen Winkelanzeiger benutzen.

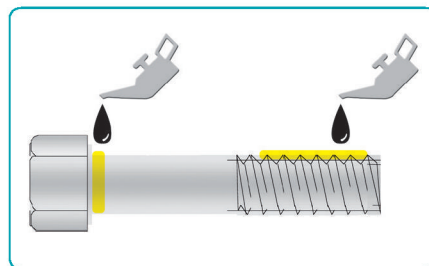

10. Wenn ein Nachziehen empfohlen ist, den Motor 20 Minuten laufen lassen. (Motoren mit Zylinderköpfen aus Aluminium müssen vor dem Nachziehen auf Raumtemperatur abkühlen).

ZYLINDERKOPFSCHRAUBEN TIPPS FÜR DAS ANZIEHEN

- Die Schrauben und Schraubenlöcher auf Sauberkeit, Schäden und vorschriftsmäßige Länge/Tiefe kontrollieren.
- Bei Sacklöchern sicherstellen, dass sie frei von Schmutz sind.
- Dehnschrauben gemäß den Richtlinien des Motorenherstellers erneuern.
- Jegliche übermäßige Anwendung von Schmier-, Dicht- und Haftmittel bei Schraubengewinden und Sacklöchern vermeiden, um die Möglichkeit eines hydraulischen Verschlusses und fehlerhaften Anziehmoments auszuschalten.
- Sicherstellen, dass die Trennflächen frei von Öl sind.
- Die Schrauben mit vorgeschriebenen Anziehmoment in der empfohlenen Reihenfolge anziehen.
- Wenn der Drehmomentschlüssel „klickt“, nicht weiter anziehen!
- Wenn erforderlich, eine Gradscheibe benutzen.
- Den Drehmomentschlüssel regelmäßig kontrollieren - insbesondere, wenn er auf den Boden gefallen ist!

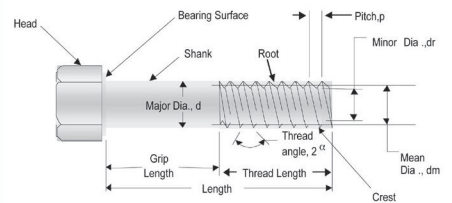

Außen-Sechskant

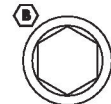

Innen-Sechskant



Außen-TORX



Innen-TORX



Außen-Stern



Innen-Stern



Zahn-Sechskant



Kleiner Sechskant

GUIDA ALL'INSTALLAZIONE PASSO A PASSO

SOSTITUZIONE DELLA GUARNIZIONE TESTA CILINDRO

1. Assicurarsi che le superfici della testata sia del monoblocco siano perfettamente pulite, libere da polvere, olio, adesivi o da residui della vecchia guarnizione. Ogni frammento sulla superficie può innescare un condotto di perdita di tenuta della nuova guarnizione. Evitare di appoggiare le superfici pulite della testata sul banco di lavoro o sul pavimento da dove potrebbero raccogliere impurità.

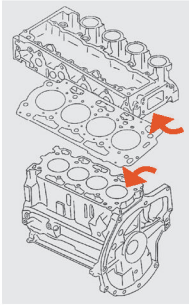

2. Avere estrema cura per non danneggiare le superfici della testa e del monoblocco quando si usa il raschietto per rimuovere la vecchia guarnizione. Questo è particolarmente importante quando le superfici sono di alluminio che può essere danneggiato più facilmente.

3. Assicurarsi che la deformazione della testata e delle superfici della testata e del monoblocco siano non superiori a 0.05 mm e che siano in linea con le raccomandazioni del costruttore.

4. Assicurarsi che tutti i fori delle viti siano puliti dai detriti, adesivi e lubrificanti. Evitare l'uso eccessivo di lubrificanti specialmente nei fori ciechi. Questo deposito potrebbe provocare un'alterazione della coppia di serraggio e un blocco idraulico che può condurre anche alla rottura del monoblocco.

5. Per i motori diesel controllare che la sporgenza dei pistoni sopra il basamento sia conforme allo spessore della guarnizione testa impiegata.



La sporgenza del pistone è la quota di quanto la testa del pistone sporge dalla superficie del monoblocco, oppure la quota di quanto il cielo del pistone è all'interno del cilindro rispetto la superficie del monoblocco.

Sporgenza + cielo del pistone che sporge dalla superficie del monoblocco

Sporgenza - cielo del pistone sotto il piano del monoblocco

Entrambe vanno misurate con il pistone al punto morto superiore.

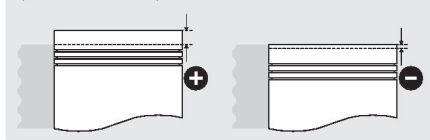

6. Evitare qualsiasi forma di collante o di adesivo sulla guarnizione della testata. Questo potrebbe portare all'estrusione del mastice e alla sua penetrazione nei passaggi olio con il conseguente danno all'intero motore. Ci sono però delle superfici dove il costruttore del motore può consigliare l'uso di un sigillante come nei giunti a "T" del coperchio anteriore.

7. Assicurarsi che la guarnizione sia montata con il verso corretto ovvero con la parte alta (TOP) verso l'alto. Inoltre, dove richiesto, posizionare i perni di riferimento prima di installare la guarnizione testa.

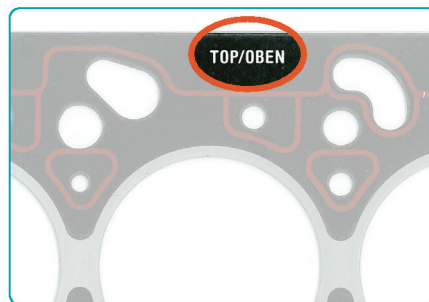

8. Controllare tutte le viti testa come lunghezza e verificarne la pulizia e l'assenza di urti o danneggiamenti. Se il motore richiede bulloni portati a stiramento, allora sostituirli sempre con viti testa nuove come raccomandato dai costruttori.

9. Oliare leggermente le filettature dei bulloni e la gola di scarico sotto la testa della vite. Avvitando i bulloni a mano si percepisce la corretta posizione quando si è in presenza di viti testa di diverse lunghezze. Serrare le viti testa secondo la sequenza raccomandata dal costruttore. Usare chiavi dinamometriche e indicatori d'angolo dove richiesto.

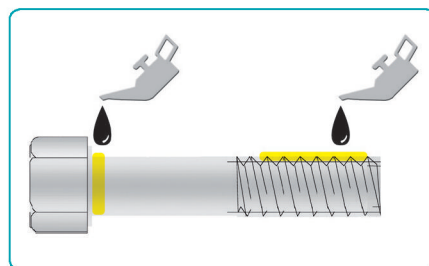

10. Quando è richiesto un doppio serraggio delle viti, è opportuno far funzionare il motore per circa 20 minuti. (I motori con testata in alluminio devono essere raffreddati fino a temperatura ambiente prima di procedere al riserraggio).

CONSIGLI PER IL SERRAGGIO DELLE VITI TESTA

- Controllare la pulizia dei bulloni e dei fori e verificare che non siano danneggiati e che abbiano la lunghezza e la profondità corrette.
- Assicurarsi che i fori ciechi siano liberi da sfridi e/o detriti.
- Sostituire i bulloni portati a stiramento secondo le norme stabilite dal costruttore del motore.
- Non fare uso eccessivo di lubrificanti, collanti o adesivi sulla filettatura e all'interno dei fori ciechi al fine di evitare il blocco idraulico della vite e l'alterazione del valore della coppia di serraggio.
- Assicurarsi che le superfici di tenuta siano pulite e libere dal lubrificante.
- Applicare alle viti le coppie di serraggio come raccomandato dal costruttore.
- Arrestare la chiave dinamometrica appena fa il tipico "click".
- Usare una chiave con goniometro se richiesto.
- Calibrare con regolarità le chiavi dinamometriche specialmente quando subiscono urti o cadono sul pavimento.

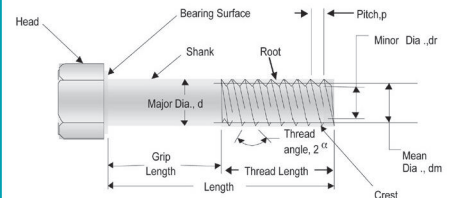

Testa esagonale



Testa a dado incassato esagonale (brugola)



Torx maschio



Torx femmina



Testa a stella maschio



Testa a stella femmina



Testa a scanalature



Testa piccola esagonale

REPLACEMENT DU JOINT DE CULASSE

1. S'assurer de la parfaite propreté des surfaces de la culasse et du bloc ainsi que de l'absence d'impuretés, d'huile, de liquide de refroidissement et de fragments de l'ancien joint. La présence de résidus sur les surfaces peut former une voie de fuite susceptible de compromettre l'efficacité du nouveau joint. Eviter de poser les culasses propres sur l'établi et/ou un sol où elles pourraient être souillées de nouvelles impuretés.
2. Utiliser le racleur avec la plus grande précaution pour déposer l'ancien joint afin de ne pas endommager les surfaces de la culasse et du bloc, tout particulièrement s'il s'agit de surfaces en aluminium plus fragiles.
3. Vérifier que la déformation de la surface de la culasse et du bloc est inférieure à 0,05 mm et que l'état de surface est conforme aux recommandations du fabricant du moteur.
4. Vérifier la propreté de tous les trous de vis, qui doivent en outre ne contenir aucun débris ou trace de liquide de refroidissement et d'huile. Eviter toute application excessive de lubrifiant, notamment dans les trous borgnes des vis. Cela pourrait provoquer un blocage hydraulique et donc affecter la force de serrage générée, ou même fissurer le bloc.
5. Pour les moteurs Diesel, mesurer le dépassement des pistons par rapport au bloc pour s'assurer que le joint de la bonne épaisseur est utilisé.

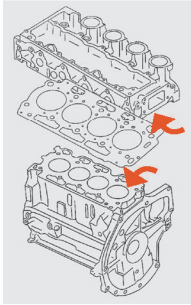

6. Eviter d'appliquer tout autre produit d'étanchéité sur le joint de culasse. Cela pourrait entraîner une extrusion et une dégradation du joint. De plus, ce produit pourrait pénétrer dans les orifices de passage d'huile, provoquant un blocage et donc une défaillance du moteur. Il peut toutefois exister des zones isolées où le fabricant du moteur peut recommander l'utilisation d'un mastic d'étanchéité, comme sur les soudures en T du carter de distribution.
7. Lors de sa pose, vérifier que le joint est bien orienté et positionné sur le moteur et, le cas échéant, qu'il est correctement disposé sur les douilles de centrage avant le montage de la culasse.

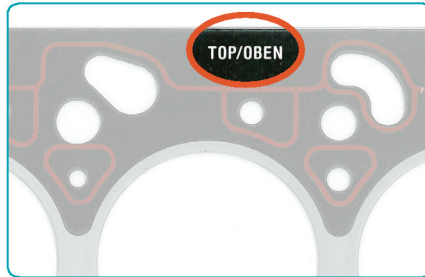

8. Contrôler la longueur de toutes les vis de culasse et veiller à ce qu'elles soient propres et en bon état. Si le moteur utilise des vis d'expansion (de type « Torque-To-Yield »), en utiliser alors des neuves conformément aux recommandations du fabricant du moteur.
9. Lubrifier légèrement le filetage et le dessous de la tête des vis de culasse. Serrer toutes les vis à la main en respectant leur position lorsqu'elles présentent différentes longueurs. Procéder ensuite au serrage des vis de culasse dans l'ordre prescrit et au couple recommandé par le fabricant du moteur. Utiliser un indicateur d'angle si nécessaire pour garantir la précision de l'angle de serrage.

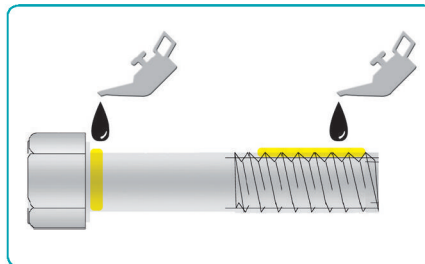

10. Faire tourner le moteur pendant 20 minutes lorsqu'un resserrage est recommandé (dans le cas d'un moteur avec culasse en aluminium, il convient de laisser refroidir ce dernier à température ambiante avant de procéder au resserrage).

CONSEILS POUR LE SERRAGE DES VIS DE CULASSE

- Vérifier que les vis et les trous sont propres, en bon état et de la bonne longueur/ profondeur.
- S'assurer que les trous borgnes sont exempts de toute impureté.
- Remplacer les vis d'expansion conformément aux directives du fabricant du moteur.
- Eviter d'utiliser une quantité excessive de lubrifiant, de produit d'étanchéité ou de produit adhésif sur les filetages et les trous borgnes des vis afin de limiter le risque de blocage hydraulique et pour pouvoir appliquer des couples de serrage corrects.
- S'assurer que les plans de joint sont bien propres et dégraissés.
- Serrer les vis à la clé dynamométrique dans l'ordre prescrit.
- Relâcher l'effort sur la clé dynamométrique lorsqu'un clic se fait entendre.
- Utiliser au besoin un rapporteur d'angles.
- Régler régulièrement la clé dynamométrique, en particulier en cas de chute !

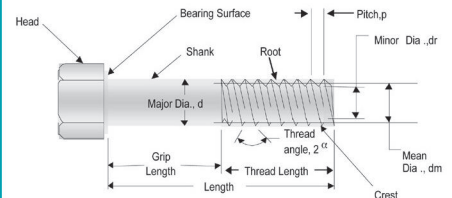

Hexagonale

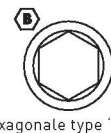

Hexagonale type "Allen"



Etoile "Torx" mâle



Etoile "Torx" intérieure/femelle



Cannelée



Cannelée intérieure/femelle

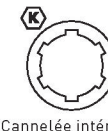

Cannelée intérieure



Mâle hexagonale avec rondelle intégrée

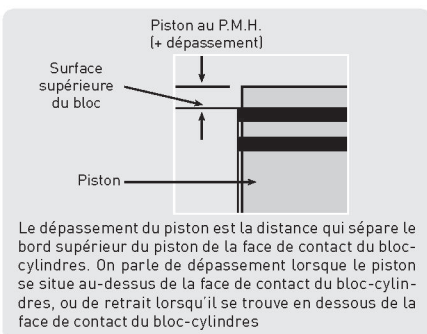

Dépassement + : sommet de la calotte du piston situé au-dessus de la face de contact du bloc-cylindres
Retrait - : sommet de la calotte du piston situé en dessous de la face de contact du bloc-cylindres
 Les deux distances sont mesurées lorsque le piston est au point mort haut (P.M.H.).

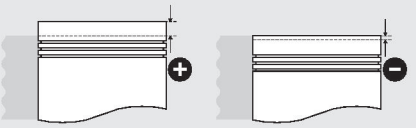

CAMBIO DE LA JUNTA DE CULATA

1. Asegúrese que las superficies del bloque de cilindros y de la culata están limpias y no presentan suciedad, aceite, refrigerante ni restos de la junta antigua. En caso de que haya restos de cualquier tipo, podrían provocar que se abriera un conducto que generara fugas, lo que estropearía la nueva junta. No deje las culatas limpias boca abajo en el banco de trabajo ni en el suelo, puesto que se le podrían adherir restos.
2. Si utiliza un rascador para quitar la junta antigua, preste mucha atención para no dañar las superficies del bloque y la culata, especialmente con las superficies de aluminio, que se dañan con más facilidad.
3. Asegúrese de que la deformación de la superficie del bloque y de la culata es inferior a 0,05 mm y que el acabado de la superficie sigue las recomendaciones del fabricante del motor.
4. Compruebe que en los orificios de los tornillos no hay restos, refrigerante ni aceite. Evite el uso excesivo de lubricante, especialmente en los orificios de los taladros ciegos, ya que podría derivar en un bloqueo hidráulico que afecte a la carga de la abrazadera generada o incluso produzca grietas en el bloque de cilindros.
5. En los motores diésel, compruebe la altura del pistón que sobresale del bloque para asegurarse de que se utiliza el grosor correcto de la junta.

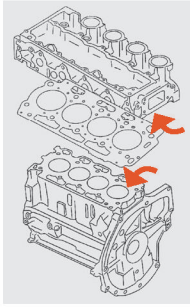

6. Evite que entre cualquier tipo de sellador suplementario en una junta de la culata, ya que podría provocar la extrusión y una avería en la junta, que además se puede introducir en los orificios de alimentación de aceite, lo que provocará un bloqueo y el consiguiente fallo del motor. Sin embargo, es posible que el fabricante del motor recomiende el uso de un sellador en algunas zonas específicas, como las juntas en forma de T de la cubierta delantera.
7. Asegúrese de que la junta está colocada en la posición correcta en el motor y, cuando sea pertinente, en las clavijas antes de ajustarla a la culata.

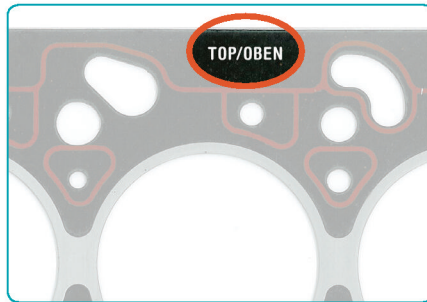

8. Compruebe que los espárragos roscados no presentan daños, que la longitud es la correcta y que están limpios. Si el motor utiliza tornillos alargados (apriete angular), utilice tornillos nuevos tal como recomienda el fabricante del motor.
9. Lubrique ligeramente la parte inferior de la rosca y la cabeza del tornillo. Apriete a mano todos los tornillos y asegúrese de que se encuentran en la posición correcta cuando haya tornillos de diferentes longitudes. Apriete los espárragos roscados en el orden recomendado por el fabricante del motor. Si es necesario ser más precisos, utilice un indicador de ángulos.

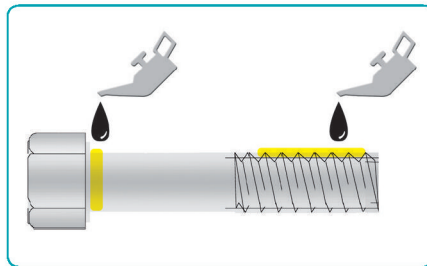

10. Cuando sea recomendable volver a realizar el apriete, ponga en funcionamiento el motor durante 20 minutos. [Cuando se trate de un motor con culata de aluminio, deje que se enfríe a temperatura ambiente antes de volver a apretarlo].

SUGERENCIAS PARA EL APRIETE DE LOS TORNILLOS DE LA CULATA

- Compruebe que los tornillos y sus orificios están limpios, no presentan daños y tienen una longitud o profundidad correctas.
- Asegúrese de que los taladros ciegos no presentan restos de ningún tipo.
- Cambie los tornillos alargados de acuerdo con las directrices del fabricante del motor.
- Evite el uso excesivo de lubricantes, selladores o adhesivos en los taladros ciegos y las roscas para mitigar la posibilidad de que se produzca un bloqueo hidráulico o que el par sea incorrecto.
- Asegúrese de que las superficies de la junta están limpias y no presentan aceite.
- Apriete los tornillos en el orden recomendado.
- Deje de girar la llave dinamoétrica cuando haga clic.
- Cuando sea necesario, utilice una llave de grados.
- Gradúe la llave dinamoétrica con regularidad, especialmente si se ha caído

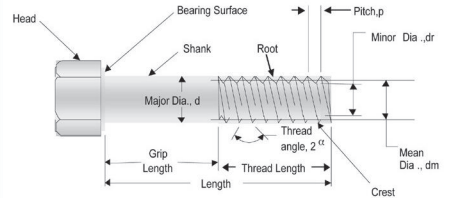

Hexagonal macho

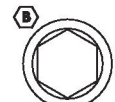

Hexagonal hembra



Torx macho



Torx hembra



Estrella macho



Estrella hembra



Estrella hembra especial



Hexagonal con arandela

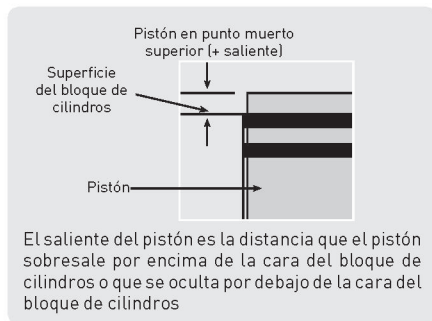

El saliente del pistón es la distancia que el pistón sobresale por encima de la cara del bloque de cilindros o que se oculta por debajo de la cara del bloque de cilindros

Saliente + parte superior de la cabeza del pistón por encima de la cara del bloque de cilindros

Saliente - parte superior de la cabeza del pistón por debajo de la cara del bloque de cilindros

Medidas con el pistón en punto muerto superior

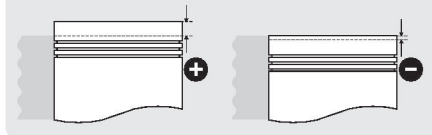

WYMIANA USZCZELKI PODGŁOWICOWEJ

1. Upewnić się, że obie powierzchnie, głowicy i bloku cylindrów są czyste i wolne od zanieczyszczeń pochodzących z oleju, środka chłodzącego, materiału uszczelki oraz pyłu. Jakiegokolwiek elementu obecnego na obu powierzchniach mogłyby spowodować powstanie przecieków, przyczyniając się do uszkodzenia nowej uszczelki. Należy unikać kładzenia oczyszczonej głowicy, powierzchnią styku z uszczelką na warsztacie lub podłodze, gdyż może to doprowadzić do ponownego zabrudzenia powierzchni.

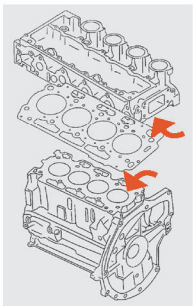

2. Należy zwracać szczególną uwagę podczas czyszczenia powierzchni z pozostałości starej uszczelki, gdyż można spowodować jej porysowanie. Jest to szczególnie ważne w przypadku powierzchni elementów aluminiowych, gdyż one łatwiej ulegają zarysowaniom.

3. Należy upewnić się, że okształcenie żadnej z powierzchni, nie przekracza 0,05 mm oraz, że wykończenie powierzchni odpowiada wymaganiom producenta silnika.

4. Należy upewnić się, że otwory pod śruby głowicowe są wolne od zanieczyszczeń oraz od obecności środka chłodzącego czy oleju. Należy unikać nadmiernego stosowania środków smarnych zwłaszcza w przypadku nieprzelotowych otworów pod śruby głowicowe. Jego obecność może doprowadzić do powstania zjawiska korka hydraulicznego, który może przeciwdziałać sile dociągającej głowicę, a w szczególnych przypadkach może doprowadzić do pęknięcia bloku.

5. W przypadku silników diesla należy sprawdzić wysokość tłoka ponad powierzchnią bloku, by upewnić się, że zastosowano uszczelkę o właściwej grubości.

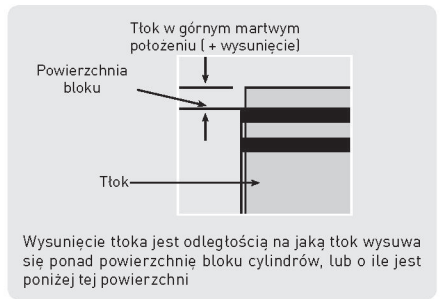

Wysunięcie dodatnie (+) jest wtedy, gdy korona tłoka wystaje ponad powierzchnię bloku cylindrów

Wysunięcie ujemne (-) jest wtedy, gdy korona tłoka jest poniżej powierzchni bloku cylindrów

Wysunięcie mierzy się gdy tłok znajduje się w górnym martwym położeniu

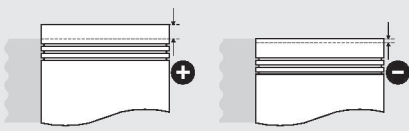

6. Należy unikać stosowania dodatkowych uszczelnień uszczelki podgłowicowych. Może to doprowadzić do odkształcenia uszczelki i jej uszkodzenia. Ponadto dodatkowe uszczelnienie może się dostać do otworów olejowych, blokując przepływ oleju, a tym samym doprowadzając do uszkodzenia silnika. Jednakowoż producent silnika może wskazać uszczelnienie, gdzie takie uszczelnienie powinno być zastosowane – np. przednia osłona łożysk typu „T”.

7. Należy upewnić się że uszczelka jest właściwie umieszczona na bloku cylindrów i w przypadkach gdzie ma to zastosowanie, właściwie ustalona na elementach ustalających, przed zamontowaniem głowicy.

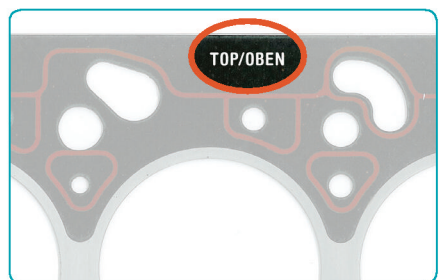

8. Należy sprawdzić wszystkie śruby głowicowe pod względem ewentualnych uszkodzeń, właściwej długości i czystości. Jeśli w silniku zastosowano śruby rozciągliwe należy zastosować nowe śruby zgodnie z zaleceniem producenta.

9. Należy delikatnie nasmarować olejem gwint śrub oraz powierzchnię pod łbem śruby. Ręcznie dokręcić wszystkie śruby upewniając się, że w przypadku zastosowania śrub o różnej długości są one umieszczone na właściwych miejscach. Dokręcać śruby w kolejności zalecanej przez producenta silnika. Należy użyć wskaźnika kąтового, w przypadkach gdzie to jest wymagane, by upewnić się o właściwym montażu.

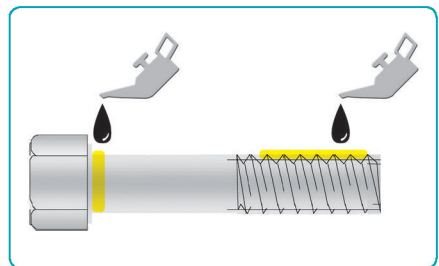

10. W przypadkach, gdy zalecane jest ponowne dokręcenie śrub, należy uruchomić silnik na 20 minut (silniki z głowicą z aluminium powinny wystygnąć do temperatury pokojowej przed ponownym dokręcaniem śrub).

ZALECENIA DOTYCZĄCE DOKRĘCANIA ŚRUB GŁOWICOWYCH

- Sprawdzić śruby i otwory pod względem czystości, uszkodzeń i właściwej długości.
- Upewnić się, że otwory nieprzelotowe nie są zanieczyszczone.
- Wymienić śruby rozciągliwe zgodnie z zaleceniem producenta silnika.
- Unikać nadmiernego stosowania smarowania, uszczelnień lub innych substancji, których obecność na gwincie śrub i powierzchniach nieprzelotowych otworów pod śruby może doprowadzić do wystąpienia „korków hydraulicznych” bądź utrudnić zastosowanie właściwego momentu dokręcającego.
- Upewnić się, że powierzchnie uszczelniane są wolne od oleju.
- Dokręcać śruby w zalecanej kolejności.
- Zaprzestać dociągania śrub, gdy klucz dynamometryczny zaczyna klikać.
- Należy użyć kąta katowego tam, gdzie jest to wymagane.
- Należy przeprowadzać regularną kalibrację klucza dynamometrycznego – zwłaszcza w przypadku, gdy upadł.

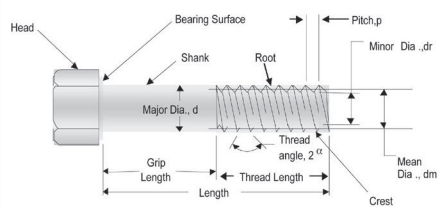

Sześciokąt męski



Sześciokąt żeński



Torx męski



Torx żeński



Gwiazda męska



Gwiazda żeńska



Sześciokąt zębaty



Sześciokąt maty

ЗАМЕНА ПРОКЛАДКИ ГОЛОВКИ БЛОКА ЦИЛИНДРОВ

- Очистите поверхности головки и блока от грязи, масла, охлаждающей жидкости и остатков старого уплотнения. Грязь на поверхности может стать причиной утечки, что приведет к выходу из строя новой прокладки. Не кладите чистые головки лицевой стороной вниз на верстак или на пол, где на них может налипнуть грязь.
- Если для удаления старой прокладки используется скребок, соблюдайте особую осторожность, чтобы не повредить поверхности головки и блока. Это особенно важно в отношении алюминиевых поверхностей, которые можно легко повредить.
- Убедитесь, что деформация поверхностей головки и блока не превышает 0,05 мм и что покрытие поверхности отвечает рекомендациям производителя двигателя.
- Убедитесь, что все отверстия под болты очищены от грязи, охлаждающей жидкости и масла. Не допускайте чрезмерного применения смазок, особенно в отверстиях для потайных болтов. Это может привести к отрицательному влиянию гидравлических пробок на возникающие зажимные усилия и даже растрескиванию блока.
- На дизельных двигателях проверьте высоту поршня над блоком, чтобы убедиться в правильной толщине используемой прокладки.

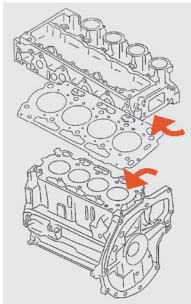

- Не наносите какой-либо дополнительный герметик на прокладку головки блока цилиндров. Это может привести к выдавливанию прокладки и выходу ее из строя. Кроме того, герметик может быть выдавлен в масляные каналы, что вызовет закупорку и дальнейший выход двигателя из строя. Однако могут быть некоторые места, в которых производитель двигателя может рекомендовать использовать герметик — например, в передней крышке двигателя.
- Перед установкой головки блока цилиндров убедитесь, что прокладка установлена нужной стороной вверх, правильно расположена на двигателе и, если применимо, установлена на шпильки.

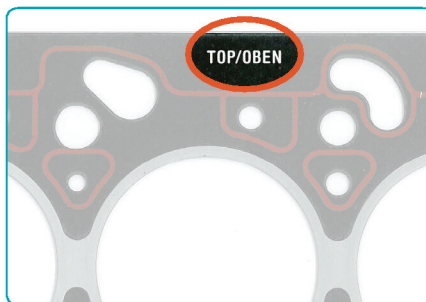

- Осмотрите все болты головки на предмет повреждений, проверьте их длину и чистоту. Если в двигателе применяются натяжные болты (удлиняющиеся при затяжке), используйте новые болты согласно рекомендациям производителя двигателя.
- Слегка смажьте резьбу и нижние поверхности головок болтов. Затяните все болты от руки; если имеются болты разной длины, убедитесь, что они используются в правильных точках. Затяните болты головки в последовательности, рекомендованной производителем двигателя. Для обеспечения точности используйте угломер там, где это требуется.

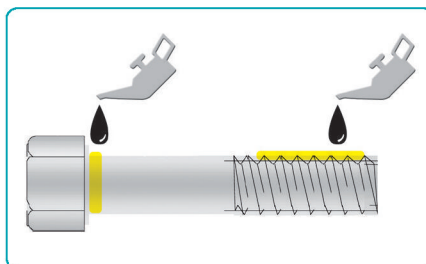

- Если рекомендуется выполнить повторную затяжку, запустите двигатель на 20 минут. (Двигатели с алюминиевыми головками блока цилиндров перед повторной затяжкой необходимо охладить до комнатной температуры).

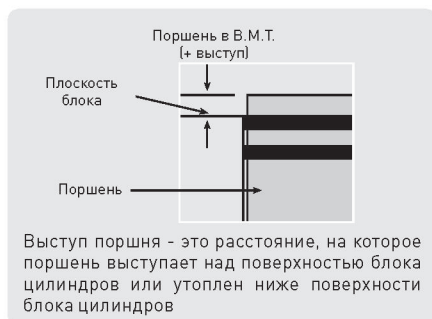

Выступ + - верх головки поршня над поверхностью блока цилиндров
Выступ - - верх головки поршня ниже поверхности блока цилиндров
 Обе величины измеряются, когда поршень находится в В.М.Т. (верхней мертвой точке)

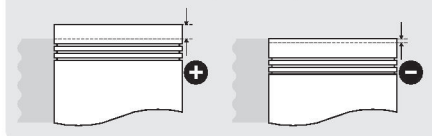

БОЛТЫ ГБЦ РЕКОМЕНДАЦИИ ПО ЗАТЯЖКЕ

- Осмотрите болты и отверстия на предмет отсутствия загрязнений, повреждений и правильной длины/глубины.
- Убедитесь, что в отверстиях под потайные болты нет мусора.
- Замените натяжные болты в соответствии с инструкциями производителя двигателя.
- Избегайте нанесения чрезмерного количества смазки, герметика или клея на резьбу болтов и в отверстия потайных болтов, чтобы уменьшить риск гидравлической пробки и неправильного момента затяжки.
- Убедитесь, что поверхности стыка чистые и не замаслены.
- Затяните болты в рекомендованной последовательности.
- Прекратите затягивать динамометрический ключ после щелчка!
- Если необходимо, используйте угломер.
- Регулярно выполняйте калибровку динамометрического ключа - особенно если его роняли!

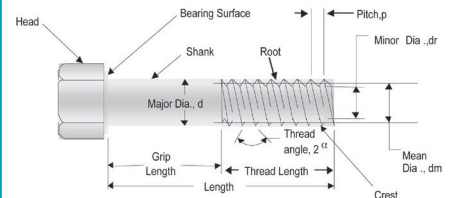

مسمار رأس الأسطوانة تلميحات للربط

- افحص المسمارين والفتحات للتأكد من نظافتها وعدم تلفها وصحة الطول/العمق.
- تأكد من خلو الفتحات غير النافذة من الحطام.
- استبدل مسمارين التمديد وفقاً لتوجيهات جهة تصنيع المحرك.
- تجنب الاستخدام الزائد لمواد التزييت أو منع التسرب أو الالتصاق على سنون لولب المسمارين وفتحات المسمارين "غير النافذة" لتقليل إمكانية القفل الهيدروليكي والعزم غير الصحيح.
- تأكد من نظافة أسطح الوصلات وخلوها من الزيت.
- اضبط عزم المسمارين مستخدماً التسلسل الموصى به.
- توقف عن سحب مفتاح العزم عند صدور صوت طقطقة!
- استخدم عجلة مدرجة عندما يلزم الأمر.
- قم بمعايرة مفتاح العزم بانتظام - وبخاصة بعد تعرضه للسقوط!

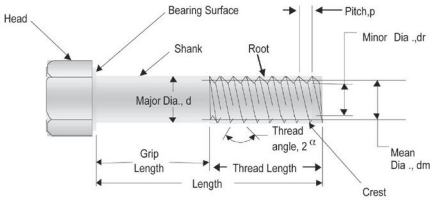

استبدال حشية رأس الأسطوانة

تجنب وضع أي نوع من أنواع مواد منع التسرب الإضافية على حشية رأس الأسطوانة. فقد يؤدي ذلك إلى قذف الحشية وعدم عملها بشكل سليم - كما قد يتم ضغط مادة منع التسرب في فتحات تغذية الزيت مسببة الانسداد وتعطل المحرك نتيجة لذلك. ورغم ذلك، قد تكون هناك مناطق منفصلة قد توصي جهة تصنيع المحرك باستخدام مادة منع تسرب بها، مثل وصلات الغطاء الأمامي على شكل "T".

تأكد من تركيب الحشية بشكل سليم لأعلى ووضعها بشكل صحيح على المحرك وعلى الدسارات، حيثما أمكن، قبل تركيب رأس الأسطوانة.

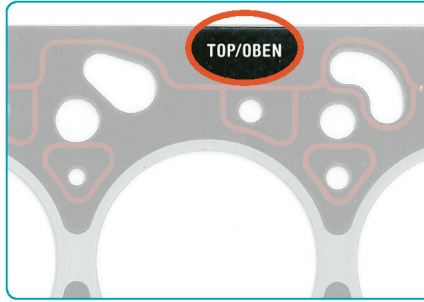

افحص جميع مسمارين الرأس للتحقق من عدم تلفها وطولها ونظافتها. وإذا كان المحرك يستخدم مسمارين تمتد (العزم إلى الإنتاجية)، فاستخدم مسمارين جديدة على النحو الموصى به من قبل جهة تصنيع المحرك.

قم بتزييت سنون لولب المسمارين والجوانب السفلية لرؤوس المسمارين خفيفاً. وارتبط جميع المسمارين بيدك متأكداً من الموضع الصحيح للمسار عند وجود مسمارين مختلفة الأطوال. واضبط عزم ربط مسمارين الرأس بالتسلسل الموصى به من قبل جهة تصنيع المحرك. واستخدم مؤشر زاوية عندما يلزم الأمر للتأكد من دقة العزم.

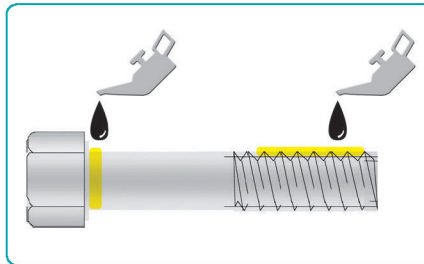

عندما يكون إعادة ضبط العزم موصى به، أدر المحرك لمدة 20 دقيقة. (ينبغي ترك المحركات ذات رؤوس الأسطوانات الألومنيوم لتبرد حتى تصل إلى درجة حرارة الغرفة قبل إعادة ضبط العزم).

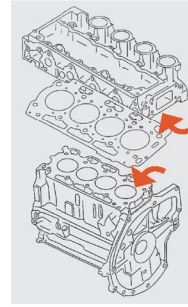

تأكد من نظافة أسطح الرأس والمجموعة وخلوها من الأوساخ والزيوت وسائل التبريد ومادة الحشية القديمة. فقد يؤدي أي حطام على الأسطح إلى وجود مسار للتسرب ينتج عنه عدم عمل الحشية الجديدة بشكل سليم. تجنب وضع الرؤوس على الطاولة أو الأرضية حيث يمكن التقاط حطام جديد.

توخ أقصى درجات الحذر لتجنب إتلاف أسطح الرأس والمجموعة في حالة استخدام مكشطة لإزالة الحشية القديمة. وبحظي هذا الأمر بأهمية خاصة مع الأسطح الألومنيوم التي تتعرض للتلف بسهولة أكثر.

تأكد أن نسبة تشوه أسطح الرأس والمجموعة أقل من 0.05 ملم وأن ملمس السطح متوافق مع توصيات جهة تصنيع المحرك.

تأكد من نظافة جميع فتحات المسمارين وخلوها من الحطام وسائل التبريد والزيوت. وتجنب الاستخدام الزائد لمادة التزييت، وبخاصة في فتحات المسمارين غير النافذة. فقد يؤدي ذلك إلى تأثير قفل هيدروليكي بشكل عكسي على حمولة الماسك الناتجة أو حتى إلى تصدع المجموعة.

بالنسبة لمحركات الديزل، افحص ارتفاع الكباس فوق المجموعة للتأكد من استخدام سُمك الحشية الصحيح.

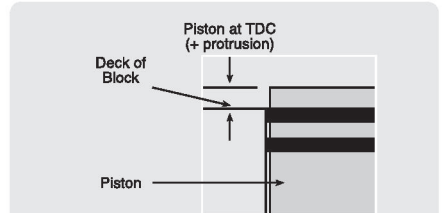

بروز الكباس هو مسافة بروز الكباس فوق سطح مجموعة الأسطوانة، أو يتم تجويفه بالفعل أسفل سطح مجموعة الأسطوانة.

البروز + قمة رأس الكباس فوق سطح مجموعة الأسطوانة البروز - قمة رأس الكباس أسفل سطح مجموعة الأسطوانة يتم قياسهما عندما يكون الكباس عند النقطة الميتة العليا (TDC)

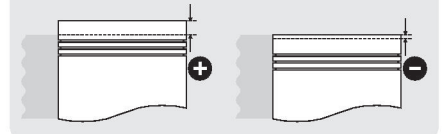

PERFORMS UNDER PRESSURE: A HERITAGE OF QUALITY AND INNOVATION WITH PAYEN®

Innovation drives success in the automotive industry. Yet, while every component of a modern light vehicle and heavy duty commercial engine is the result of continuous design and manufacturing improvement, few products have seen as much change – or as much innovation – as sealing components.

When it comes to delivering innovative gasket designs that clearly outperform the competition in both the original equipment and replacement markets, Federal-Mogul Corporation's Payen brand truly stands alone.

Federal-Mogul is the world's leading manufacturer of OE cylinder head gaskets and static sealing components. This OE leadership means that every Payen gasket is the result of truly world-class R&D processes and extensive insight into the demands of today's engines and manufacturing processes that ensures unsurpassed quality and performance.

The Payen range is supported by four global R&D centres, each equipped with state-of-the-art technologies and systems to ensure that the brand maintains and extends its market leadership through superior sealing solutions.

With 200 scientists and engineers addressing every element of a sealing component – from material formulation to physical design – as well as 26 engine test beds for light vehicle and commercial engines, Federal-Mogul's Payen brand provides the ideal answer to any sealing challenge.

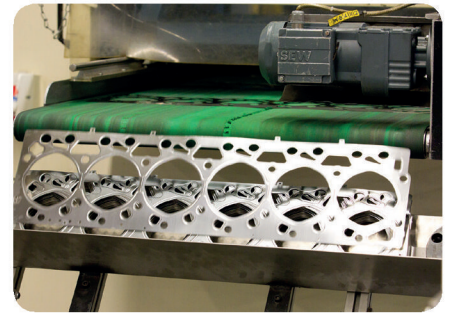
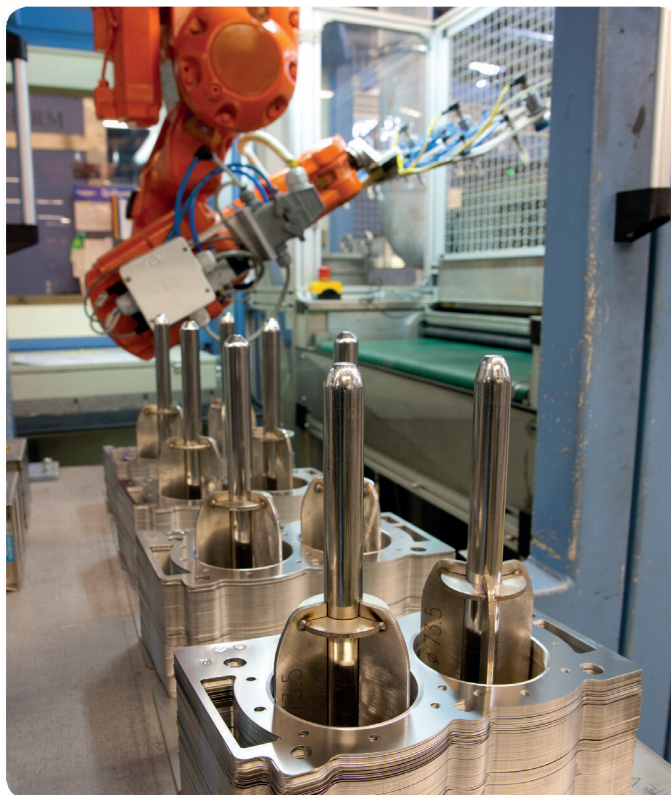

THRIVING IN THE WORLD'S MOST DEMANDING MARKET

Payen products from Federal-Mogul PERFORM UNDER PRESSURE in the world's most demanding business environment: the OE light and commercial vehicle engine market. Federal-Mogul's unique ability to deliver innovative, ultra-reliable sealing technologies has led to strong business relationships with most of world's premier OEM's.

The Federal-Mogul Sealing Systems facility in Herdorf, Germany, plays a vital role in serving thousands of OE and Aftermarket customers. This highly advanced operation has produced millions of innovative sealing products featuring HTA (High Temperature Alloy), MLS (Multi-Layer Steel) and LASPOT technologies. The Herdorf facility is well equipped for the challenges of the 21st century through Federal-Mogul's leadership in quality and constraint management systems. In honour of these and other achievements, Federal-Mogul Sealing Systems GmbH received the prestigious "TOP 100" Award from the German Ministry of Economic Affairs.

CONCEPT TO REALITY: LEADERSHIP IN EVERY PART

Among the leading strengths of the Federal-Mogul Herdorf engineering team are the commitment to continuous improvement and the will to explore and validate new ideas – all while focusing on the needs of every customer. By utilising innovative materials and designs combined with leading-edge processes, Federal-Mogul and the Payen brand can meet the demands of any challenging application and business objective.

This aggressive pursuit of quality and innovation can be seen in every Payen product. As one example, Federal-Mogul engineers developed the LASPOT head gasket to address customer requests for a design in which the stopper performs the primary sealing function for applications with increased combustion pressures. Each LASPOT head gasket features the latest welded stopper technology



LEM® (LIQUID ELASTOMER MOULDING) GASKETS

Federal-Mogul's LEM gaskets have been extremely successful in helping OEMs solve difficult sealing challenges, particularly in joints requiring significant design flexibility. More than 40 million LEM gaskets have been manufactured for OE and aftermarket since LEM was introduced in 1998. LEM gaskets are now well established in the Payen range offering.

This technology is ideally suited to the Aftermarket. The topographic sealing beads on Payen LEM gaskets can accommodate up to 30% greater flange distortion than competing technologies. This is particularly important as engine designers use lightweight flanges and lower bolt loads. LEM technology is also appropriate for tomorrow's fuel cells – and these sealing solutions will become part of the Payen range as this promising market emerges.

to meet the needs of today's most demanding diesel engines. Other key features of these gaskets are functional layers manufactured from spring stainless steel embossed with full and half beads in a specially developed "closed", or matched-tool, concept. This approach ensures a durable seal along a linear sealing zone. For exceptional micro-sealing, all layers are coated with a high-grade, permanently stable fluoroelastomer.

MLS (MULTI-LAYER STEEL) GASKETS

Federal-Mogul has been an undisputed leader in multi-layer steel (MLS) head gasket technology for nearly 20 years. The company has produced more than 43 million OE MLS head gaskets in Herdorf, and the plant is also a leading provider to the replacement parts market. This OE success is due in part to Federal-Mogul's process experience and independence in product and tool technology. Whether concerned with the highly precise design and manufacture of embossment tools, meeting extreme gasket coating demands or developing high-performance welding equipment for applying the stopper, Federal-Mogul engineers identify and apply the best ideas and technologies to ensure the optimum products for each engine.

STEEL-ELASTOMER GASKET DESIGNS

Sealing of heavy duty diesel engines often requires a different design approach. The combustion pressures are greater than those seen on light vehicle applications and the expectations for long term durability are much higher.

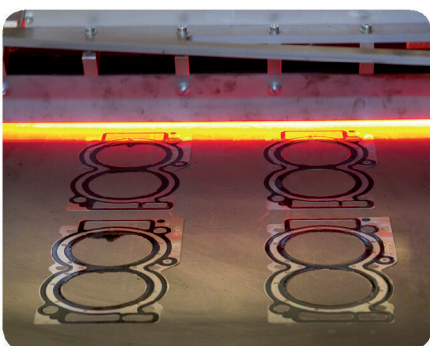

The dominant sealing technology used for this market segment is known as steel-elastomer. Gaskets often consist of a steel plate which is embossed around the bore area to seal combustion gas with fluid sealing being achieved by elastomeric seals normally moulded to the steel plate. This type of design provides a highly stable and efficient sealing system with excellent high temperature sealing properties.

As with smaller engines, there is a trend for lighter yet more durable engine structures and higher power densities requiring further advances in gasket design. Latest steel-elastomer designs can incorporate high-performance elastomers with bore sealing systems that can utilise topographic elements as well as MLS technology to seal combustion pressures in excess of 250 bar.

AWARD-WINNING HTA™ (HIGH TEMPERATURE ALLOY) GASKETS

The need for higher output from smaller engines has led to increased exhaust temperatures, which can have detrimental effects on exhaust gaskets. To help engine OEMs address this issue, Federal-Mogul has developed a range of new gasket material technologies and product designs. One of these – the HTA (High Temperature Alloy) gasket – offers a step-change improvement in exhaust gas sealing.

This new technology, a winner of the prestigious Automotive News PACE Award for Innovation in 2007, is exceptionally resistant to thermal creep and can withstand temperatures up to 1000°C. The innovation was made possible only through Federal-Mogul's global expertise in materials science, especially in the fields of metals, coatings and surface chemistry.

Aftermarket customers of Federal-Mogul are already reaping the benefits of HTA technology via the introduction of parts into the Payen brand.

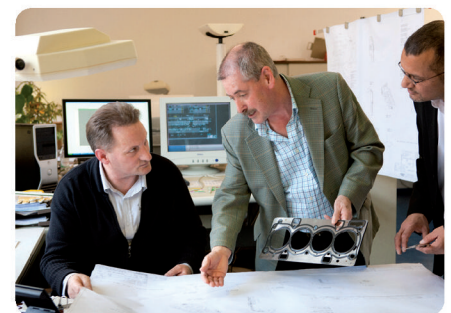

PAYEN PERFORMS UNDER PRESSURE

Sealing components have never been more important to the overall performance and reliability of automotive engines. Increased cylinder pressures and temperatures, as well as reduced engine mass, have made the science of sealing one of the most complex and demanding areas of engine design. With an unsurpassed level of expertise within both the OE and replacement markets, Payen is the brand that PERFORMS UNDER PRESSURE for virtually any sealing challenge on any automotive engine. In short, Federal-Mogul's Payen brand is the new standard in sealing technology.



HÖCHSTLEISTUNG UNTER DRUCK: BEWÄHRTE QUALITÄT UND INNOVATION MIT PAYEN®

In der Automobilindustrie wird der Erfolg von Innovation bestimmt. Aber obwohl jedes Teil eines modernen Pkw- und Lkw-Motors das Ergebnis fortlaufender Verbesserung bei Design und Fertigung ist, gab es bei kaum einem anderen Produkt so viele Veränderungen - und Innovationen - wie bei Dichtungskomponenten.

Als Anbieter von innovativen Dichtungsdesigns, im Serien- (OE-) als auch Ersatzgeschäft, setzt die Marke Payen von Federal-Mogul immer wieder neue Standards.

Federal-Mogul ist der weltweit führende Hersteller von OE-Zylinderkopfdichtungen und anderen Dichtungskomponenten. Dank dieser führenden Position im OE-Markt basiert jede Payen-Dichtung auf Forschungs- und Entwicklungsprozessen (F&E), die die umfassenden Anforderungen an moderner Motoren und Fertigungsprozesse abdecken.

Das Produktangebot von Payen wird durch vier globale F&E-Zentren unterstützt, die alle mit modernsten Technologien und Systemen ausgerüstet sind, um die führende Position der Marke durch erstklassige Dichtungslösungen zu sichern und auszuweiten.

Mit 200 Wissenschaftlern und Ingenieuren, die sich von der Werkstoffzusammensetzung bis hin zur physischen Planung mit jedem Bestandteil einer Dichtung befassen, sowie 26 Motorprüfständen für Pkws und Nutzfahrzeuge bieten Federal-Mogul und die Marke Payen die perfekte Lösung für jedes Dichtungsproblem.

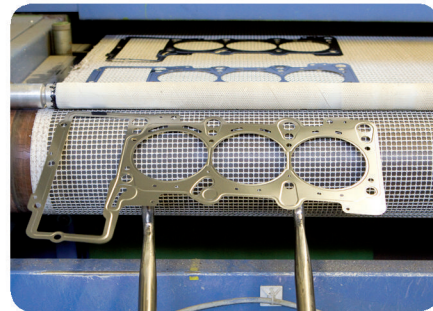

ERFOLGREICH IM ANSPRUCHSVOLLSTEN MARKT DER WELT

Die Payen-Produkte von Federal-Mogul bieten HÖCHSTLEISTUNG UNTER DRUCK im weltweit anspruchsvollsten Geschäftsumfeld: Dem OE Markt für Pkw- und Nutzfahrzeugmotoren. Durch die große Kompetenz, innovative und zuverlässige Dichtungstechnologien bereitzustellen, konnte Federal-Mogul starke Geschäftsbeziehungen mit den global führenden OEM aufbauen. Federal-Moguls Fertigungsanlage für Dichtungssysteme in Herdorf leistet einen wichtigen Beitrag zur Versorgung von tausenden Kunden im OE-Markt und Aftermarket. Dieser hochmoderne Betrieb fertigt Millionen innovativer Dichtungsprodukte mit HTA- (Hochtemperatur-Legierung), MLS- (mehrlagiger Stahl) und LASPOT®- Technologien. Dank Federal-Moguls führender Position in punkto Qualität und Constraint-Management-Systemen ist das Werk in Herdorf bestens auf die Herausforderungen des 21. Jahrhunderts vorbereitet. In Anerkennung dieser und anderer Leistungen erhielt die Federal-Mogul Sealing Systems GmbH die Auszeichnung „TOP 100“ vom Bundeswirtschaftsministerium.

VOM KONZEPT ZUR UMSETZUNG: HERVORRAGEND IN JEDEM TEIL

Zu den führenden Stärken des Teams in Herdorf zählen sein Engagement für kontinuierliche Verbesserung und sein Wille, neue Ideen zu erforschen und validieren. Gleichzeitig wird besonderes Augenmerk auf die Erfordernisse jedes einzelnen Kunden gerichtet. Durch Nutzung innovativer Werkstoffe und Designs kombiniert mit modernsten Herstellungsverfahren ist Federal-Mogul und die Marke Payen in der Lage, die Anforderungen aller anspruchsvollen Anwendungen zu erfüllen.

Dieser ehrgeizige Fokus auf Qualität und Innovation zeigt sich in jedem Payen-Produkt. Ingenieure bei Federal-Mogul entwickelten beispielsweise die LASPOT Zylinderkopfdichtung, um Kundenwünschen

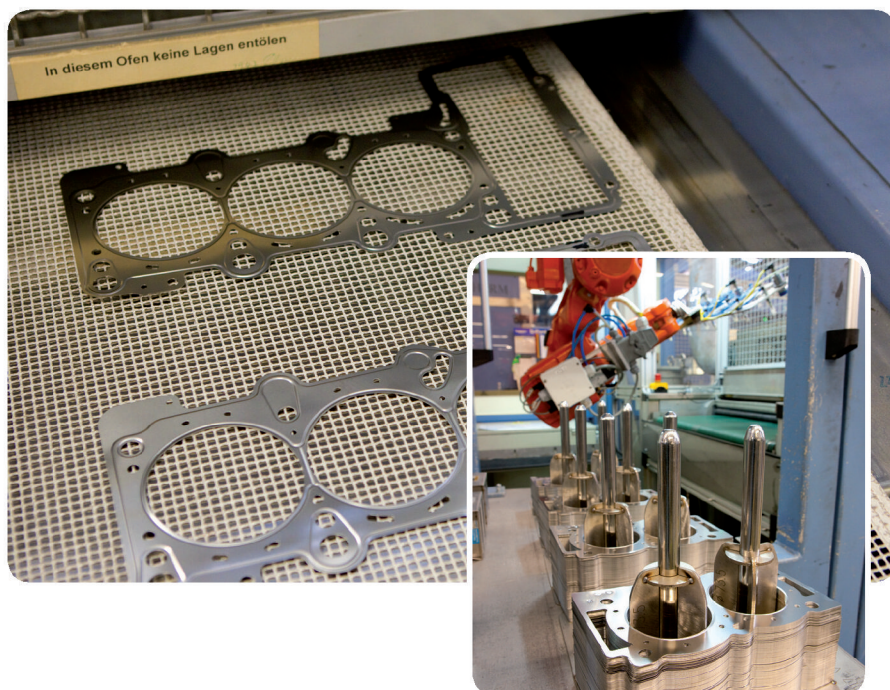



nach einem Design gerecht zu werden, bei dem der Stopper in Anwendungen mit erhöhten Verbrennungsdrücken die primäre Dichtungsfunktion übernimmt. Jede LASPOT Zylinderkopfdichtung verfügt über die neueste, geschweißte Stoppertechnologie, um auch die höchsten Erfordernisse moderner Dieselmotoren zu erfüllen. Andere wichtige Merkmale dieser Dichtungen sind Funktionsschichten aus rostbeständigem Federbandstahl mit Voll- und Halbwülsten in einem speziell entwickelten „geschlossenen“ oder „Matched-Tool“-Konzept. Dieser Ansatz sorgt für eine haltbare Dichtung entlang einer linienförmigen Dichtzone. Um eine unübertroffene Mikrodichtung zu erreichen, werden alle Schichten mit einem hochgradigen, dauerhaft stabilen Flourelastomer beschichtet.

MLS DICHTUNGEN (DICHTUNGEN AUS MEHRLAGIGEM STAHL)

Federal-Mogul ist seit fast 20 Jahren einer der Marktführer für MLS-Zylinderkopfdichtungstechnik. Das Unternehmen hat bis heute über 43 Millionen OE MLS-Dichtungen in Herdorf produziert und ist außerdem ein führender Zulieferer für den Ersatzteilmarkt. Dieser Erfolg im OE-Geschäft beruht teilweise auf der Prozess Erfahrung von Federal-Mogul und seiner unabhängigen Position bei Produkt- und Werkzeugtechnik. Egal ob es um hochpräzise Konzipierung und Fertigung von Prägwerkzeugen, die Erfüllung extremer Anforderungen an die Dichtungsbeschichtung oder die Entwicklung von Hochleistungs-Schweißgeräten für das Anbringen der Stopper geht - die Ingenieure von Federal-Mogul finden und realisieren die besten Ideen und Technologien, um für jeden Motor die optimalen Produkte zu liefern.

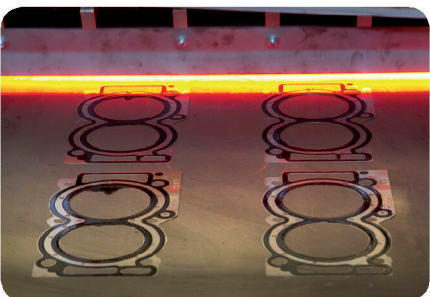

STAHL-ELASTOMER-DICHTUNGEN

Die Abdichtung von Nutzfahrzeugdieselmotoren erfordert oftmals einen anderen Lösungsansatz, da die Verbrennungsdrücke höher sind als in Pkw-Motoren und auch die Erwartungen an die Langzeithaltbarkeit deutlich höher sind.

Die dieses Marktsegment beherrschende Dichtungstechnik ist eine Stahl-Elastomer-Konstruktion. Diese Dichtungen bestehen zumeist aus einer Stahlplatte mit Sicken um den Bohrungsbereich zur Abdichtung des Brennraums und normalerweise an die Stahlplatte geformten Elastomerdichtungen zur Abdichtung der Flüssigkeitskanäle. Mit dieser Bauweise wird eine hochstabile und effiziente Abdichtung mit ausgezeichneten Hochtemperaturdichteigenschaften erzielt. Wie bei kleineren Motoren geht auch hier der Trend zu leichteren und haltbareren Motorkonstruktionen sowie höheren Leistungsdichten - und infolgedessen neuen Anforderungen an die Dichtungen. Moderne Stahl-Elastomer-Dichtungen kombinieren unter Einsatz von sowohl topografischen Elementen als auch MLS-Technologie (Mehrlagen-Stahldichtungen), Hochleistungselastomere mit Bohrungsabdichtungssystemen für Verbrennungsdrücke über 250 bar.

PREISGEKRÖNTE HTA™-DICHTUNGEN (HOCHTEMPERATUR-LEGIERUNG)

Mit dem Bedarf nach höheren Leistungen von zunehmend kleineren Motoren haben sich die Auspuffrohrtemperaturen erhöht, was sich nachteilig auf die Auspuffrohrdichtungen auswirken kann. Um den Motorenherstellern bei der Lösung dieses Problems zu helfen, hat Federal-Mogul eine Reihe neuer Dichtungsmaterialtechniken und Produktdesigns entwickelt. Eine dieser Technologien - die HTA-Dichtung (Hochtemperatur-Legierung) - stellt eine sprunghafte Verbesserung für Auspuffrohrdichtungen dar.

Die neue Technologie, ausgezeichnet mit dem „Automotive News PACE Award for Innovation“ (2007), weist außerordentliche Beständigkeit gegenüber thermischem Kriechen auf und hält Temperaturen bis zu 1.000° C stand. Diese Innovation wurde durch Federal-Moguls globale Expertise in den Materialwissenschaften und speziell in den Bereichen Metalle, Beschichtungen und Oberflächenchemie ermöglicht. Die Aftermarket-Kunden von Federal-Mogul profitieren durch die Einführung von Teilen im Payen-Sortiment bereits von der HTA-Technologie.



LEM®-DICHTUNGEN (LIQUID ELASTOMER MOULDING)

Die LEM-Dichtungen von Federal-Mogul leisten einen wesentlichen Beitrag zur Lösung schwieriger Dichtungsprobleme bei den Motorenherstellern, speziell erhöhen sie die Konstruktionsfreiheit an den schwierig abzdichtenden Anschlußstellen. Über 40 Millionen LEM-Dichtungen wurden für das OE-Geschäft wie auch den Aftermarket seit der Produkteinführung im Jahr 1998 produziert. Im Payen-Produktprogramm sind die LEM-Dichtungen nun bestens für den Aftermarket platziert.

Diese Technologie eignet sich bestens für den Aftermarket. Die topografischen Dichtwülste der Payen LEM-Dichtungen können im Vergleich mit Konkurrenzprodukten eine bis zu 30 Prozent stärkere Flanschverformung aufnehmen. Dies ist besonders wichtig, da Motorenkonstruktoren die Flansche gewichtsoptimieren und niedrigere Bolzenlasten verwenden. Die LEM-Technologie eignet sich außerdem für die Brennstoffzellen der Zukunft - und diese Dichtungslösungen werden mit dem Auftauchen dieses vielversprechenden Markts in das Payen-Sortiment aufgenommen werden.



PAYEN - HÖCHSTLEISTUNG UNTER DRUCK

Dichtungskomponenten waren noch nie zuvor so wesentlich für die Leistungsfähigkeit und Zuverlässigkeit von Fahrzeugmotoren. Durch erhöhte Zylinderdrücke und -temperaturen sowie reduzierte Motorengröße ist die Dichtungstechnik heute eine der komplexesten und anspruchsvollsten Bereiche bei der Motorenkonstruktion. Mit unübertroffener Kompetenz sowohl im OE- als auch im Ersatzgeschäft ist Payen die Marke, die für praktisch jedes Dichtungsproblem bei allen Fahrzeugmotoren HÖCHSTLEISTUNG UNTER DRUCK bietet. Kurz gesagt - Payen ist der neue Standard für die Dichtungstechnologie.



MASSIMA TENUTA, MASSIMA PRESTAZIONE: IL PATRIMONIO PAYEN® FATTO DI QUALITÀ ED INNOVAZIONE

L'innovazione è il motore del settore automobilistico. Tutti i componenti dei motori moderni per veicoli leggeri e pesanti sono il risultato di continui miglioramenti nella progettazione e nella produzione, ma pochi prodotti hanno visto così tanti cambiamenti o innovazioni come i componenti di tenuta.

Quando si parla di progettare guarnizioni innovative che surclassano la concorrenza sia nel mercato dei componenti originali che in quello dei pezzi di ricambio, il marchio Payen di Federal-Mogul regna incontrastato.

Federal-Mogul è il leader mondiale nella produzione di guarnizioni testa cilindro e componenti di tenuta statici OE. La leadership delle guarnizioni Payen nel mercato OE nasce da processi di ricerca e sviluppo all'avanguardia e da un ampio studio delle richieste dei motori e dei processi di produzione moderni che assicura prestazioni e qualità senza pari.

Quattro centri R&D internazionali, ciascuno dotato di sistemi e tecnologie all'avanguardia, assicurano che il marchio Payen mantenga ed estenda la propria leadership di mercato attraverso soluzioni di tenuta di qualità eccellente.

Grazie all'impegno di 200 tecnici ed ingegneri, Federal-Mogul e il marchio Payen forniscono la soluzione ottimale a qualsiasi sfida inerente ai componenti di tenuta: analizzano, infatti, ogni singola fase di realizzazione del pezzo, dalla mescola alla progettazione fisica, come pure i test su 26 banchi prova per i motori dei veicoli.

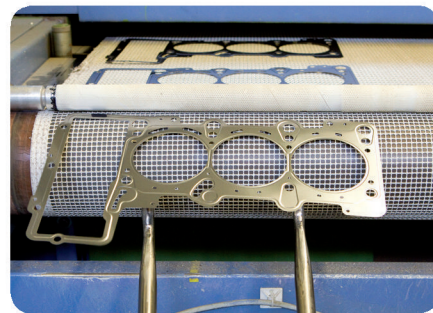

IL SUCCESSO NEL MERCATO PIÙ ESIGENTE AL MONDO

I prodotti Payen di Federal-Mogul sono sempre all'avanguardia nell'ambiente commerciale più esigente al mondo: il mercato OE dei motori per veicoli commerciali e leggeri. La capacità unica di Federal-Mogul di offrire tecnologie di tenuta innovative ed estremamente affidabili ha condotto alla nascita di saldi rapporti commerciali con i principali produttori OEM internazionali.

Lo stabilimento di Federal-Mogul a Herdorf, in Germania, gioca un ruolo fondamentale nella fornitura di prodotti a migliaia di clienti del mercato OE e dell'aftermarket. Sfruttando sistemi altamente avanzati, questo stabilimento ha prodotto milioni di componenti di tenuta innovativi basati sulle tecnologie HTA (High Temperature Alloy), MLS (Multi-Layer Steel) e LASPOT®. L'impianto di Herdorf è ben strutturato per affrontare le sfide del 21° secolo attraverso la leadership di Federal-Mogul secondo i più moderni sistemi di gestione della qualità totale. Per questi e altri obiettivi raggiunti Federal-Mogul Sealing Systems GmbH è stata insignita del prestigioso premio "TOP 100" dal Ministero degli Affari economici tedesco.

DALLA PROGETTAZIONE ALLA REALIZZAZIONE: I PRIMI IN OGNI FASE DI PRODUZIONE

Tra i punti di forza del team di Herdorf vi sono l'impegno verso il costante miglioramento e la volontà di esplorare e verificare nuove idee, il tutto ponendo l'attenzione sulle esigenze di ciascun cliente. Grazie all'utilizzo di materiali e design innovativi uniti all'impiego di processi all'avanguardia, Federal-Mogul e il marchio Payen sono in grado di soddisfare le richieste di qualsiasi applicazione e di raggiungere obiettivi commerciali di grande impegno.

La ricerca costante di qualità e innovazione è visibile in tutti i prodotti Payen. Per fare un esempio, gli ingegneri di Federal-Mogul hanno sviluppato la guarnizione testa LASPOT® per rispondere alle richieste da parte dei clienti di una soluzione in cui il dispositivo





DESIGN DI GUARNIZIONI IN ACCIAIO-ELASTOMERO

I sistemi di tenuta per motori diesel "heavy duty" esigono spesso un approccio progettuale diverso: le pressioni di combustione sono maggiori rispetto a quelle osservate nelle applicazioni di veicoli commerciali leggeri e le aspettative riguardanti la durata a lungo termine sono di gran lunga superiori. La principale tecnologia di tenuta adottata per questo segmento di mercato è nota come acciaio-elastomero. Le guarnizioni sono spesso costituite da una piastra in acciaio, sbalzata attorno all'area del foro, atta alla tenuta del gas di combustione, mentre la tenuta dei fluidi è assicurata da elementi di tenuta elastomerici solitamente uniti alla piastra in acciaio mediante formatura. Questo tipo di design crea un sistema di tenuta altamente stabile ed efficiente avente eccellenti proprietà di tenuta ad alta temperatura.

svolgesse una prima funzione di tenuta nelle applicazioni con pressioni di combustione maggiori. Ogni guarnizione testa LASPOT® sfrutta la tecnologia di ultima generazione sulla saldatura degli anelli in corrispondenza dei cilindri per rispondere alle crescenti necessità dei motori diesel moderni. Altre caratteristiche fondamentali di queste guarnizioni sono gli strati in acciaio inossidabile armonico dotati di cordoni in elastomero che garantiscono una chiusura sempre ermetica. Questo approccio garantisce un'affidabilità di tenuta su tutte le superfici interessate. Per ottenere una microsiggillatura di qualità eccezionale, tutti gli strati sono rivestiti con uno speciale materiale in fluoroelastomero che permette qualità e stabilità di tenuta permanenti.

GUARNIZIONI IN ACCIAIO MULTISTRATO

Federal-Mogul è leader indiscusso della tecnologia delle guarnizioni testa in acciaio multistrato da quasi 20 anni. L'azienda ha prodotto più di 43 milioni di guarnizioni testa OE in acciaio multistrato nello stabilimento di Herdorf e questo stesso stabilimento è anche un fornitore leader nel mercato dei pezzi di ricambio.

Il successo nel mercato OE è dovuto in parte all'esperienza ed autonomia tecnologica di Federal-Mogul negli strumenti, nei processi e nei prodotti. Che si tratti di progettazione, di produzione ad alta precisione, di goffratura, di rivestimenti rinforzati o dello sviluppo di tecnologie di saldatura ad alte prestazioni per le tenute, gli ingegneri di Federal-Mogul identificano e applicano le idee e le tecnologie migliori per assicurare la massima qualità nei prodotti per ciascun motore.

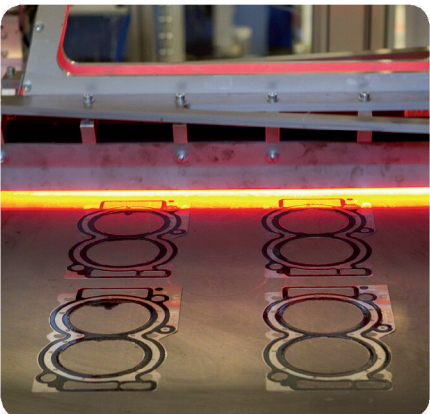

Analogamente ai motori di dimensioni minori, si preferiscono attualmente strutture del motore più leggere ma più durature e densità di potenza superiori che esigono ulteriori progressi nella progettazione delle guarnizioni. I più recenti design in acciaio-elastomero possono comprendere elastomeri ad alte prestazioni con sistemi di tenuta del foro in grado di utilizzare elementi topografici così come la tecnologia MLS per garantire la tenuta a pressioni di combustione superiori a 250 bar.

GUARNIZIONI HTA™ (HIGH TEMPERATURE ALLOY) PREMIATE

La necessità di ottenere un rendimento superiore da motori più piccoli ha portato all'aumento delle temperature di scarico, con conseguente effetto usurante sulle guarnizioni di scarico. Per aiutare i produttori OEM di motori a risolvere questo problema, Federal-Mogul ha sviluppato una nuova gamma di tecnologie di materiali per guarnizioni e nuove progettazioni. Una di queste, la guarnizione HTA (High Temperature Alloy), offre un miglioramento sostanziale nella tenuta dei gas di scarico.

Questa nuova tecnologia, vincitrice del prestigioso Automotive News PACE Award for Innovation, presenta una resistenza eccezionale alla deformazione termica ed è in grado di sopportare temperature fino a 1000° C. L'innovazione in Federal-Mogul è stata possibile solo grazie all'abilità e alla conoscenza dei materiali metallici, e della chimica delle superfici.

I clienti aftermarket di Federal-Mogul stanno già godendo dei benefici della tecnologia HTA grazie alla sua introduzione nella gamma Payen attuale.



GUARNIZIONI LEM® (LIQUID ELASTOMER MOULDING)

Le guarnizioni LEM di Federal-Mogul hanno contribuito notevolmente a risolvere le difficili sfide nei sistemi di tenuta che si sono presentate ai produttori OEM, in particolare per gli snodi che richiedono una notevole flessibilità di design. Dall'introduzione del marchio LEM nel 1998 sono state prodotte oltre 40 milioni di guarnizioni LEM per il settore OE e per il mercato dei ricambi. Le guarnizioni LEM si sono affermate nella gamma di prodotti Payen.

Questa tecnologia è ideale per l'impiego in aftermarket. I cordoni di tenuta, infatti, presenti sulle guarnizioni Payen LEM possono sopportare fino al 30% in più di distorsione del supporto metallico rispetto alle tecnologie concorrenti. Ciò è particolarmente importante quando i progettisti di motori utilizzano strati leggeri e carichi di serraggio minori. La tecnologia LEM è inoltre adatta alle future celle a combustibile e diverrà parte della gamma Payen con l'emergere di questo promettente mercato.

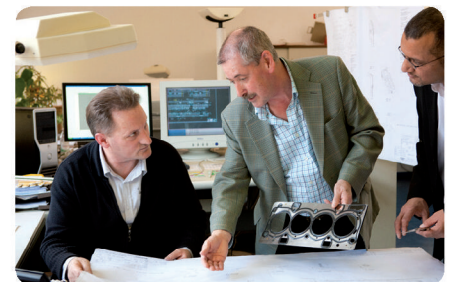

PAYEN: MASSIMA TENUTA, MASSIMA PRESTAZIONE

I componenti di tenuta non sono mai stati così importanti per le prestazioni e l'affidabilità complessive dei motori automobilistici. L'aumento delle temperature e delle pressioni nei cilindri, nonché la riduzione della massa del motore, hanno fatto della scienza dei sistemi di tenuta una delle aree di progettazione più complesse ed impegnative. Grazie all'elevato livello di esperienza e conoscenza sia nel mercato OE/OES che Aftermarket, Payen è il marchio MASSIMA TENUTA, MASSIMA PRESTAZIONE per praticamente qualsiasi applicazione di tenuta su qualsiasi motore automobilistico. In altre parole, Payen è il nuovo standard nella tecnologia dei sistemi di tenuta.



L'ÉTANCHÉITÉ SOUS PRESSION : LA TRADITION DE LA QUALITÉ ET DE L'INNOVATION AVEC PAYEN®

L'innovation est le moteur du succès au sein de l'industrie automobile. Toutefois, même si chaque composant des motorisations modernes pour véhicules légers ou poids-lourds est le fruit d'améliorations continues en termes de conception et de fabrication, rares sont les produits qui ont connu autant d'évolutions (ou autant d'innovations) que les composants d'étanchéité.

La marque Payen de Federal-Mogul est réellement la seule à offrir des modèles de joints innovants dont les performances sont nettement supérieures à celles de la concurrence aussi bien en première monte que sur le marché des pièces de rechange.

Federal-Mogul est le plus grand fabricant mondial de joints de culasse et d'éléments d'étanchéité statique d'origine. Ce positionnement dans le domaine des équipements de première monte est l'assurance que chaque joint Payen est le fruit de processus de R&D de dimension véritablement internationale ainsi que d'une connaissance approfondie des exigences des moteurs et des procédés de fabrication d'aujourd'hui, offrant ainsi la garantie d'une qualité et de performances inégalées.

La gamme Payen bénéficie de l'appui de quatre centres mondiaux de R&D, chacun équipé de technologies et de systèmes de pointe pour s'assurer que la marque conserve et étende son leadership sur le marché grâce à des solutions d'étanchéité hors pair.

Forts d'un effectif de 200 scientifiques et ingénieurs traitant chacun des composants d'une pièce d'étanchéité - de la formulation des matériaux à la conception physique -, ainsi que de 26 bancs d'essais pour motorisations de véhicules légers et poids-lourds, Federal-Mogul et la marque Payen apportent la réponse idéale à tous les défis en matière d'étanchéité.

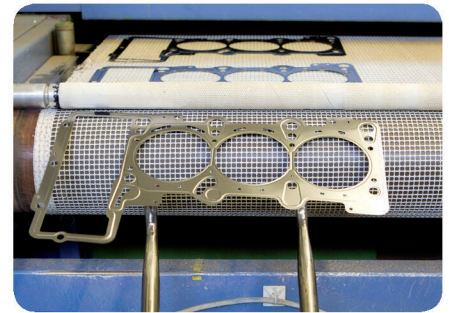

UNE MARQUE PROSPÈRE SUR LE MARCHÉ LE PLUS EXIGEANT DU MONDE

Les produits Payen de Federal-Mogul excellent sous pression au sein d'un des marchés les plus exigeants au monde : le marché première monte des moteurs pour véhicules légers et poids-lourds. La capacité unique de Federal-Mogul à fournir des technologies d'étanchéité novatrices et ultra-fiables a permis d'établir de solides relations commerciales avec les constructeurs les plus importants de la planète.

Le site de production de systèmes d'étanchéité de Federal-Mogul à Herdorf, en Allemagne, joue un rôle fondamental en répondant aux besoins de milliers de clients en première monte et en rechange. Cette usine hautement perfectionnée a fabriqué des millions de produits d'étanchéité innovants, dotés de technologies à alliage haute température HTA (High Temperature Alloy), en acier multi-feuille MLS (Multi-Layer Steel) et LASPOT®. Le site de Herdorf s'est doté des outils nécessaires pour relever les défis du 21ème siècle grâce au leadership de Federal-Mogul dans les systèmes de gestion de la qualité et des contraintes. Pour rendre hommage à ces réalisations et d'autres encore, le Ministère allemand des affaires économiques a remis le prestigieux prix « TOP 100 » au site Federal-Mogul Sealing Systems GmbH.

DU CONCEPT À LA RÉALITÉ : UN LEADERSHIP OMNIPRÉSENT

Parmi les principaux points forts de l'équipe de Herdorf figurent une volonté d'amélioration continue et l'envie d'explorer et de valider de nouvelles idées tout en restant à l'écoute des besoins de chaque client. En exploitant des conceptions et des matériaux innovants, conjugués à des procédés d'avant-garde, Federal-Mogul et la marque Payen sont en mesure de satisfaire aux exigences les plus difficiles pour toute application et pour tout objectif commercial.

Chaque produit Payen est représentatif de cette ambitieuse quête de qualité et d'innovation. A titre d'exemple, les ingénieurs de Federal-Mogul ont mis au point le joint de culasse LASPOT® en vue de répondre aux

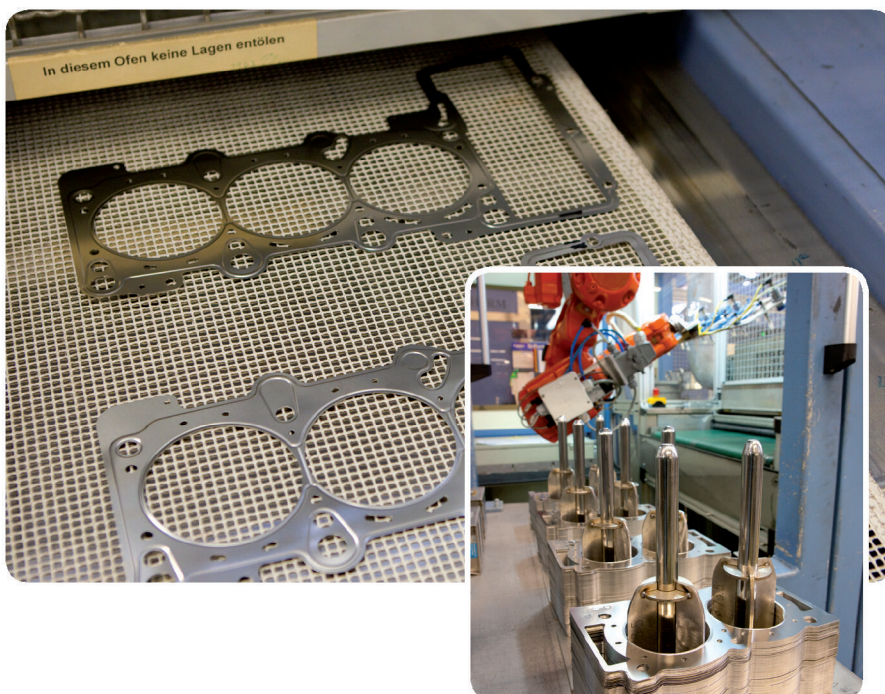



demandes des clients recherchant un modèle dans lequel la butée remplit la fonction principale d'étanchéité pour supporter des pressions de combustion plus élevées. Chaque joint de culasse LASPOT est doté de la dernière technologie de butée soudée au laser en vue de répondre aux besoins des moteurs Diesel les plus exigeants d'aujourd'hui. Ces joints présentent d'autres caractéristiques majeures telles que des couches fonctionnelles réalisées en acier inoxydable à ressort moulé avec des cordons complets et des demi-cordons dans un concept « fermé » (principe du moule et contre-moule spécialement développé). Cette approche assure une étanchéité durable le long d'une zone d'étanchéité linéaire. Pour une micro-étanchéité d'exception, toutes les couches sont revêtues d'un fluoroélastomère de première qualité et d'une stabilité permanente.

JOINTS MLS (ACIER MULTI-FEUILLE)

Cela fait près de 20 ans que Federal-Mogul est le leader incontesté en matière de technologie de joint de culasse en acier multi-feuille. A Herdorf, la société a produit plus de 43 millions de joints de culasse MLS de première monte. L'usine allemande est également l'un des principaux fournisseurs du marché des pièces de rechange.

Ce succès en première monte s'explique en partie par l'expérience des procédés de Federal-Mogul et par son indépendance en matière de technologies de produits et d'outils. Qu'il s'agisse de la conception et de la fabrication d'outils d'emboutissage de haute précision, de répondre à des exigences extrêmes en matière de revêtements de joints, ou de mettre au point un matériau de soudage de haute performance pour l'application de la butée, les ingénieurs de Federal-Mogul identifient et mettent en œuvre les meilleures idées et les meilleures technologies afin de garantir des solutions optimales pour chaque moteur.

JOINTS DE TYPE ACIER-ÉLASTOMÈRE

L'étanchéité des moteurs Diesel de poids lourds nécessite souvent une approche conceptuelle différente. Les pressions de combustion sont plus importantes que dans

un moteur de véhicule léger et les attentes quant à la durabilité à long terme sont beaucoup plus grandes.

La technologie d'étanchéité la plus répandue pour ce segment de marché est connue sous le nom de joint acier-élastomère. Ces joints sont souvent constitués d'une plaque en acier qui est nervurée au niveau des alésages afin d'assurer l'étanchéité aux gaz de combustion. L'étanchéité aux fluides est réalisée quant à elle par des joints en élastomère qui sont généralement moulés sur la plaque d'acier. Ce type de conception permet d'obtenir un système très stable et efficace qui présente d'excellentes propriétés d'étanchéité à haute température.

A l'image des moteurs de cylindrée inférieure, on peut observer une tendance d'une part à la réalisation de structures de moteur plus légères mais néanmoins durables, et d'autre part à l'augmentation de la puissance volumique. De nouvelles avancées en matière de conception de joints sont par conséquent nécessaires. Les derniers modèles de type acier-élastomère peuvent ainsi intégrer des élastomères hautes performances et disposer de systèmes d'étanchéité d'alésage faisant appel à des éléments en relief ainsi qu'à l'acier multi-feuille pour garantir l'étanchéité à des pressions de combustion supérieures à 250 bars.

JOINTS HTA™ (ALLIAGE HAUTE TEMPÉRATURE) PRIMÉS AUX « PACE AWARD » DU MAGAZINE AUTOMOTIVE NEWS

La nécessité d'obtenir un rendement plus élevé pour les moteurs plus petits s'est traduite par une augmentation des températures d'échappement et donc par des effets néfastes potentiels sur les joints de collecteur d'échappement. Afin d'aider les motoristes à régler cette question, Federal-Mogul a mis au point une gamme de nouvelles solutions de matériaux de joint. Parmi eux, le joint HTA (High Temperature Alloy - alliage haute température) constitue une amélioration radicale en matière d'étanchéité aux gaz d'échappement. Cette nouvelle technologie, l'un des lauréats du prestigieux « Automotive News PACE Award 2007 » dans la catégorie Innovation, offre une résistance exceptionnelle au flUAGE thermique et peut supporter des températures allant jusqu'à 1 000°C. Cette innovation n'a été possible que grâce aux compétences internationales de Federal-Mogul en science des matériaux, en particulier dans les domaines des métaux, des revêtements et de la chimie des surfaces.

Grâce aux pièces introduites dans la gamme Payen, la clientèle de Federal-Mogul en deuxième monte peut d'ores et déjà mettre à profit les avantages de la technologie HTA.



JOINTS LEM® (ÉLASTOMÈRE LIQUIDE MOULÉ)

Les joints en élastomère liquide moulé LEM (Liquid Elastomer Moulding) de Federal-Mogul ont connu un vif succès en aidant les constructeurs à résoudre des problèmes d'étanchéité assez complexes, notamment au niveau des jonctions exigeant une souplesse de conception importante. Plus de 40 millions de joints LEM ont été fabriqués pour les marchés de l'origine et de la rechange depuis que le LEM fût introduit en 1998. Les joints LEM sont aujourd'hui des produits bien connus au sein de la gamme proposée par Payen.

Cette technologie est parfaitement adaptée aux besoins du marché de deuxième monte. Les cordons d'étanchéité topographiques des joints LEM de Payen peuvent résister à un degré de distorsion de plan jusqu'à 30 % supérieur à celui des technologies concurrentes. Cela est particulièrement important compte tenu du fait que les concepteurs de moteurs utilisent des rebords légers et des couples de serrage inférieurs. La technologie LEM est également appropriée pour les piles à combustion de demain. Aussi, dès l'émergence de ce marché prometteur, ces solutions d'étanchéité feront leur entrée dans la gamme Payen.

PAYEN : L'ÉTANCHEITÉ SOUS PRESSION

L'importance des composants d'étanchéité pour le rendement global et la fiabilité des moteurs automobiles a atteint un niveau sans précédent. L'augmentation des pressions et des températures des cylindres ainsi que la réduction de la masse des moteurs ont fait de la science de l'étanchéité l'un des domaines de la conception de moteurs les plus complexes et les plus exigeants. Forte d'un niveau de savoir-faire inégalé tant en première monte qu'au sein du marché des pièces de rechange, la marque Payen est synonyme d'ÉTANCHEITÉ SOUS PRESSION et offre une réponse à la quasi-totalité des défis d'étanchéité des moteurs automobiles. En résumé, Payen est la nouvelle référence en matière de technologies d'étanchéité.

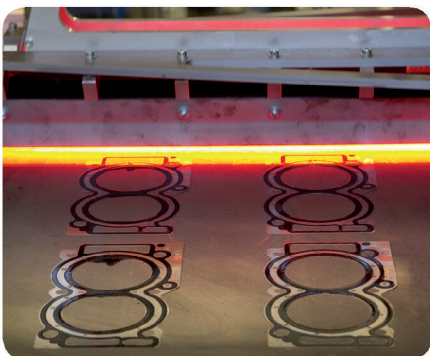

FUNCIONA BAJO PRESIÓN. TRADICIÓN DE CALIDAD E INNOVACIÓN CON PAYEN®

La innovación es el motor del sector de la automoción. Todos los componentes que se utilizan en la actualidad en motores industriales de carga pesada o de vehículos industriales ligeros son el resultado de una mejora continua en el diseño y la fabricación, aunque hay pocos productos que hayan sufrido tantos cambios –o tanta innovación– como los componentes de sellado.

A la hora de elegir un diseño de junta innovador que supere claramente a la competencia tanto en el mercado de equipo original como de recambios, la marca Payen de Federal-Mogul Corporation destaca notablemente.

Federal-Mogul es el fabricante de componentes de sellado estáticos y juntas de culata de equipo original más importante del mundo, lo que significa que cada junta de Payen es el resultado de procesos de I+D de excelente calidad y del gran conocimiento de las exigencias de los procesos de fabricación y los motores actuales, que garantiza una calidad y un rendimiento insuperables.

La gama Payen está respaldada por cuatro centros de I+D en todo el mundo, cada uno de los cuales cuenta con los últimos sistemas y tecnologías para garantizar que la marca mantiene y amplía su situación dominante en el mercado mediante productos de sellado superiores.

En dichos centros, cada elemento de los componentes de sellado –desde la formulación de los materiales hasta el diseño físico– está supervisado por 200 científicos e ingenieros, y se dispone de 26 bancos de pruebas para motores industriales e industriales ligeros. Por eso, Federal-Mogul y la marca Payen son la opción ideal para cualquier necesidad que se presente relacionada con el sellado.

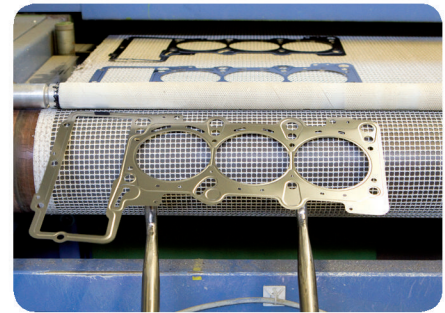

PROSPERAR EN EL MERCADO MÁS EXIGENTE DEL MUNDO

En el entorno comercial más exigente del mundo, el mercado de motores para vehículos industriales e industriales ligeros de equipo original, los productos de Payen «funciona bajo presión». Gracias a su capacidad única de proporcionar tecnologías de sellado realmente fiables e innovadoras, Federal-Mogul han conseguido establecer y consolidar relaciones comerciales con los mejores fabricantes de equipo original del mundo.

Las modernas instalaciones de Federal-Mogul Sealing Systems en Herdorf, Alemania, tienen un papel esencial en la empresa, ya que dan servicio a miles de clientes de recambios y equipo original. En ellas se han producido millones de innovadores productos de sellado que incorporan las tecnologías HTA (aleación para altas temperaturas, del inglés, High Temperature Alloy), MLS (acero multicapa, del inglés, Multi-Layer Steel) y LASPOT. Gracias a sus sistemas de gestión de calidad y restricciones, dichas instalaciones están perfectamente preparadas para afrontar los retos del siglo XXI. En honor a estos y a otros logros, Federal-Mogul Sealing Systems GmbH ha recibido del Ministerio de Economía alemán el prestigioso galardón de «Las 100 mejores empresas».

LIDERAZGO EN CADA PIEZA, DESDE QUE SE CONCEBE HASTA QUE SE MATERIALIZA

Entre los puntos fuertes más importantes del Federal-Mogul equipo de Herdorf se encuentra el compromiso por una mejora continua y la voluntad de explorar y aplicar nuevas ideas, sin olvidar las necesidades de cada cliente. Gracias al uso de innovadores materiales y diseños combinados con los procesos más novedosos, Federal-Mogul, de la mano de la marca Payen, puede satisfacer todos los objetivos comerciales y de aplicación exigentes.

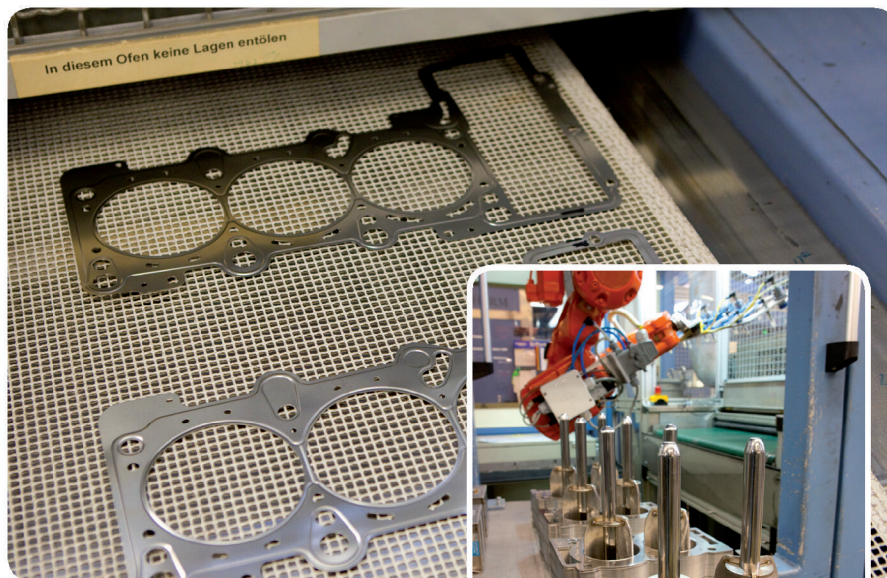



Esta imparables búsqueda de la calidad y la innovación se observa en todos y cada uno de los productos de Payen. Como ejemplo, los ingenieros de Federal-Mogul desarrollaron la junta de culata LASPOT para los clientes que querían utilizar un diseño en el que el refuerzo hiciera la función de sellado principal en las aplicaciones con mayores presiones de combustión. Con la junta de culata LASPOT, que incorpora la última tecnología de refuerzos soldados, se cubren las necesidades de los motores diésel más exigentes del mercado. Además, estas juntas presentan otras características clave como son las capas funcionales curvadas de acero inoxidable en relieve con refuerzos medios y enteros en un concepto «cerrado» desarrollado específicamente. De este modo se garantiza un sellado duradero a lo largo de una zona de sellado lineal. Para conseguir un sellado microscópico excepcional, todas las capas se revisten con un fluoroelastómero estable permanente de alta calidad.

JUNTAS DE MLS (ACERO MULTICAPA, DEL INGLÉS, MULTI-LAYER STEEL)

Federal-Mogul lleva 20 años siendo, indiscutiblemente, el fabricante más importante en lo que se refiere a la tecnología de juntas de culata de acero multicapa (MLS). Prueba de ello es que la empresa ha producido más de 43 millones de juntas de culata de MLS para equipo original en Herdorf, una planta que también tiene un gran peso en el mercado de los recambios.

Esta importancia en el sector de equipo original en parte se debe a la experiencia y a la independencia que demuestra tener Federal-Mogul en la tecnología de las herramientas y los productos, ya que sus ingenieros se dedican a establecer y aplicar las mejores ideas y tecnologías para garantizar que cada producto es el óptimo para cada motor, ya sea en el diseño de alta precisión y la fabricación de herramientas de relieve, o en la satisfacción de las necesidades extremas de revestimiento de juntas y el desarrollo de equipos de alto rendimiento de soldadura para la aplicación del refuerzo.

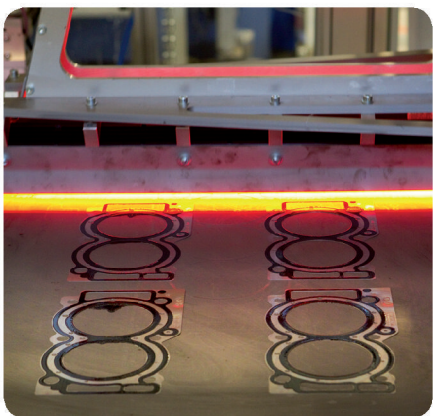

DISEÑOS DE JUNTAS DE ACERO Y ELASTÓMERO

Para el sellado de motores diésel de vehículos pesados suele ser necesario enfocar el diseño desde un punto de vista diferente. Las presiones de combustión son mucho mayores que las de las aplicaciones de vehículos comerciales, como también lo son las expectativas de durabilidad a largo plazo. La tecnología de sellado que se emplea mayoritariamente para este segmento de mercado es la que utiliza acero y elastómero. Por regla general, las juntas se componen, por una parte, de una placa de acero que se coloca alrededor del borde para sellar el gas de la combustión y, por otra parte, de juntas elastoméricas amoldadas a la placa de acero con las que se consigue el sellado de los líquidos. Con este tipo de diseño se obtiene un sistema de sellado muy estable y eficaz con excelentes propiedades de sellado a altas temperaturas. Al igual que sucede con los motores de menor tamaño, se tiende hacia unos niveles de potencia superiores y unas estructuras de motor más ligeras y con mayor durabilidad, lo que exige nuevos avances en el diseño de juntas. Los diseños en acero y elastómero más recientes pueden incorporar elastómeros de alto rendimiento con un sistema de sellado de bordes que pueden aplicar tanto elementos topográficos como la tecnología MLS (acero multicapa) para sellar presiones de combustión superiores a 250 bar.

JUNTAS HTA™ (ALEACIÓN PARA ALTAS TEMPERATURAS, DEL INGLÉS, HIGH TEMPERATURE ALLOY) PREMIADAS

Dado que cada vez se exige más potencia en motores más pequeños, la temperatura de los gases de escape ha aumentado, lo que puede tener efectos perjudiciales para las juntas del colector de escape. Para ayudar a que los fabricantes de equipo original solucionen este problema, Federal-Mogul ha desarrollado una nueva gama de diseños de productos y tecnologías para materiales de juntas. Uno de estos productos (la junta de HTA) mejora radicalmente el sellado en los gases de escape.

Esta nueva tecnología, que ha conseguido el prestigioso premio Automotive News PACE 2007 con el que se galardona la innovación de productos, es resistente a la fluidez térmica y puede soportar temperaturas de hasta 1.000 °C. Esta innovación ha sido posible gracias a la experiencia internacional de Federal-Mogul en el ámbito de los materiales, especialmente en el campo de los metales, los recubrimientos y la química de superficie. Puesto que ya se han introducido en la gama Payen referencias que incorporan esta tecnología, los clientes de recambios de Federal-Mogul ya se están beneficiando de las ventajas que representa.



JUNTAS LEM® (MOLDEADO DE ELASTÓMERO LÍQUIDO, EN INGLÉS, LIQUID ELASTOMER MOULDING)

Las juntas LEM de Federal-Mogul han supuesto una inestimable ayuda para los fabricantes de equipo original en la resolución de problemas de sellado complejos, en particular en las articulaciones que requieren una flexibilidad de diseño significativa. Se han fabricado más de 40 millones de juntas LEM (elastómero líquido moldeado) para equipos originales y recambios desde que apareciera esta tecnología en 1998. En la actualidad, las juntas LEM están muy consolidadas en la gama Payen.

Esta tecnología es ideal para el mercado de los recambios: el asiento de los refuerzos en zonas curvadas de sellado de las juntas LEM de Payen pueden absorber hasta un 30% más de deformación que las tecnologías de la competencia. Esta característica es importante especialmente porque los diseñadores de motores utilizan asientos ligeros y no aprietan tanto los pernos. La tecnología LEM también tendrá un peso importante en las pilas de combustible que se creen en un futuro, de hecho, estas soluciones de sellado se convertirán en parte de la gama Payen a medida que vaya emergiendo este prometedor mercado.

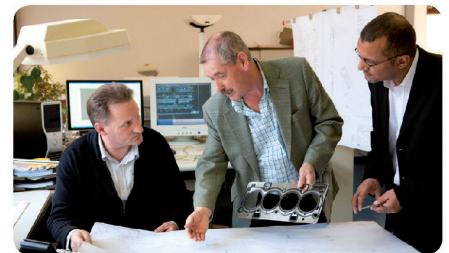

PAYEN FUNCIONA BAJO PRESIÓN

Nunca antes los componentes de sellado habían sido tan importantes para el rendimiento y la fiabilidad de los motores de automoción. El aumento de las presiones y temperaturas en el cilindro, así como la reducción de la masa del motor, han hecho del sellado una de las ciencias más complejas y exigentes en lo que respecta al diseño del motor. Con un insuperable nivel de experiencia tanto en equipo original como en los recambios, Payen es la marca que FUNCIONA BAJO PRESIÓN en prácticamente todas las necesidades de sellado de cualquier motor de automóvil. En resumen, Federal-Mogul Payen marca las reglas en lo que se refiere a tecnologías de sellado.



PEWNOŚĆ W KAŻDYCH WARUNKACH: EFEKT JAKOŚCI I INNOWACYJNOŚCI MARKI PAYEN®

Innowacje i rozwój technologii jest główną przyczyną sukcesu przemysłu motoryzacyjnego. Obecnie, każdy element nowoczesnych silników samochodów osobowych lub ciężarowych jest wynikiem ciągłego udoskonalania metod konstrukcyjnych, badawczych i produkcyjnych. W takiej sytuacji niewiele elementów zmieniło się tak bardzo, jak bardzo zmieniły się elementy uszczelnienia.

W sytuacji, gdy potrzebujemy innowacyjnych rozwiązań w zakresie uszczelnień silnikowych, o właściwościach przewyższających to, co mogą zaoferować konkurenci zarówno w dostawach na montaż fabryczny OE, jak i na rynek części zamiennych wybór jest praktycznie jeden – to Payen, marka należąca do koncernu Federal-Mogul Corporation.

Federal-Mogul jest światowym liderem w produkcji na potrzeby montażu fabrycznego OE w zakresie uszczelnień podgotowiwanych i uszczelnień statycznych. Wiodąca rola w dostawach na OE oznacza, że każda uszczelka Payen jest wynikiem doświadczeń światowej klasy ośrodków badawczych (R&D), głębokiej analizy współczesnego procesu produkcyjnego oraz wymagań nowoczesnych silników, co zapewnia osiągnięcie nowych poziomów efektywności działania i jakości.

Produkty wchodzące w skład programu Payen korzystają ze wsparcia czterech światowych centrów badawczo-rozwojowych (R&D), z których każdy dysponuje najnowocześniejszą technologią badawczą. Umożliwia to utrzymanie wiodącej pozycji dzięki zapewnieniu ciągłego podnoszenia jakości i opracowywaniu nowoczesnych rozwiązań w zakresie uszczelnień.

Dzięki ciągłemu zaangażowaniu 200 naukowców i inżynierów, pracujących nad każdym elementem w pełnym zakresie, od badań materiałowych po końcowy projekt oraz możliwością wykorzystania w badaniach 26 stanowisk testowych dla silników osobowych i ciężarowych, Federal-Mogul i marka Payen zapewniają idealne rozwiązania dla każdego wyzwania w zakresie uszczelnień.

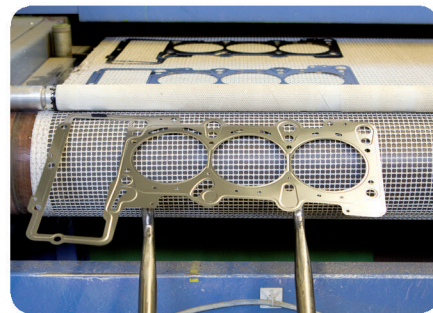
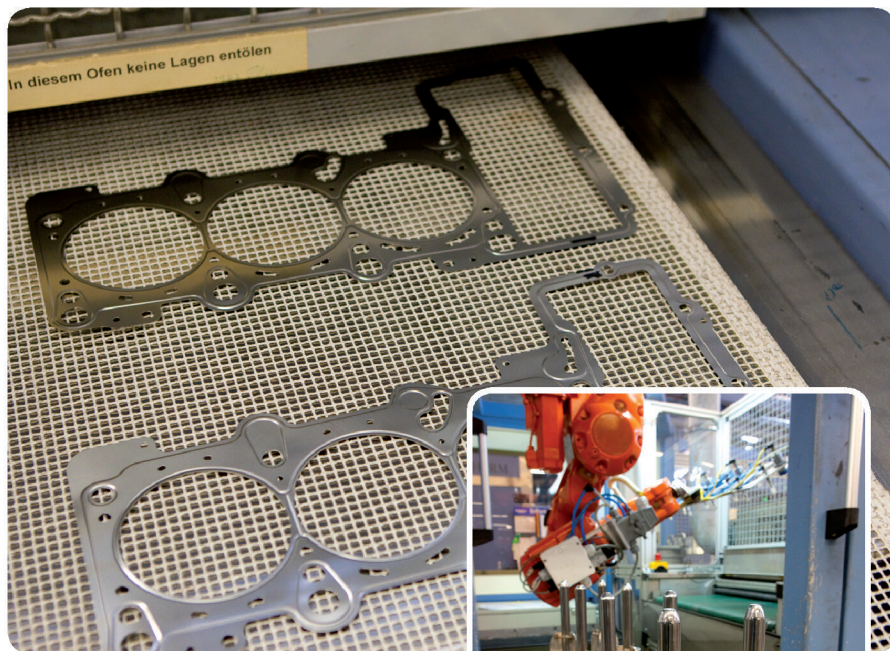

CIĄGŁY ROZWÓJ NA NAJBARDZIEJ WYMAGAJĄCYM RYNKU ŚWIATA

Produkty Payena z koncernu Federal-Mogul to „PEWNOŚĆ W KAŻDYCH WARUNKACH” na światowym rynku dostaw na montaż fabryczny OE silników do samochodów osobowych i ciężarowych. Unikalna zdolność Federal-Mogul do dostarczania innowacyjnych, wyjątkowo niezawodnych technologii w zakresie uszczelnień, doprowadziła do wytworzenia silnych relacji biznesowych z wiodącymi producentami samochodów.

Dział Systemów Uszczelnień Federal-Mogul w Herdorf w Niemczech gra kluczową rolę w obsłudze tysięcy klientów zarówno z grupy producentów OE, jak i rynku części zamiennych. Ten nowoczesny zakład wyprodukował miliony innowacyjnych uszczelnień wykorzystujących technologię HTA (technologia stopu wysokotemperaturowego), MLS (uszczelnienia stalowe wielowarstwowe) czy technologię LASPOT. Oddział w Herdorf jest doskonale wyposażony i przygotowany do spełniania wyzwań XXI wieku dzięki wiodącej roli jakości produktów w Federal-Mogul oraz wewnętrznym systemom utrzymania jakości. Dzięki tym oraz wielu innym osiągnięciom Federal-Mogul Sealing Systems GmbH otrzymał prestiżową nagrodę Niemieckiego Ministerstwa Gospodarki – „TOP 100”.

POMYSŁ NA RZECZYWISTOŚĆ: BYĆ NAJLEPSZYM W KAŻDEJ CZĘŚCI

Pośród wiodących silnych stron załogi Federal-Mogul Herdorf są wiara w nieustający rozwój i determinacja w tworzeniu i stosowaniu nowych rozwiązań – za każdym razem skupiając się na tym, czego potrzebuje klient. Dzięki stosowaniu innowacyjnych materiałów i konstrukcji, wykorzystujących najbardziej zaawansowane technologie Federal-Mogul wraz z marką Payen są w stanie spełniać wymagania wszelkich pojawiających się zadań oraz realizować wszystkie założone cele.



To zdecydowanie w dążeniu do najwyższej jakości jest widoczne w każdym produkcie Payen. Jako przykład może służyć opracowana przez inżynierów Federal-Mogul konstrukcja LASPOT. Ta konstrukcja uszczelki podgłowicowej została wprowadzona na życzenie klientów i polega na wprowadzeniu stopera, który realizuje wstępne uszczelnienie w przypadkach silników o zwiększonym ciśnieniu spalania. W produkcji każdej uszczelki podgłowicowej wykonanej w technologii LASPOT wykorzystuje się najnowocześniejszą technologię spawania stoperów, konieczną do spełnienia warunków panujących w najbardziej wymagających współczesnych silnikach diesla. Innymi kluczowymi właściwościami uszczelki tego typu są specjalne warstwy wytworzone z nierdzewnej stali sprężynowej ukształtowanej w specjalnie opracowanym procesie produkcyjnym. To rozwiązanie zapewnia trwałe uszczelnienie stref liniowych. Dla zapewnienia wyjątkowej szczelności wszystkie warstwy są pokrywane wysokoelastycznym, trwałym fluoroelastomerem.

MLS (MULTI-LAYER STEEL) GASKETS - WIELOWARSTWOWE USZCZELKI STALOWE

Federal-Mogul jest niekwestionowanym liderem w produkcji uszczelki podgłowicowych MLS od niemal 20 lat. Firma wyprodukowała ponad 43 miliony uszczelki MLS na montaż fabryczny OE w samym tylko oddziale w Herdorf, który jest także liderem w zaopatrywaniu rynku części zamiennych. Sukces w dostawach na montaż fabryczny OE jest wynikiem doświadczenia Federal-Mogul oraz niezależnego rozwoju technologii produkcji i oprzyrządowania.

Inżynierowie Federal-Mogul wprowadzają najlepsze rozwiązania technologiczne, by móc produkować zaawansowane konstrukcje zawierające elementy precyzyjnego tłoczenia, zaawansowanego spawania stoperów czy stosowania specjalnych powłok powierzchni. Wszystko to, aby zapewnić optymalne dopasowanie produktów do każdego silnika.

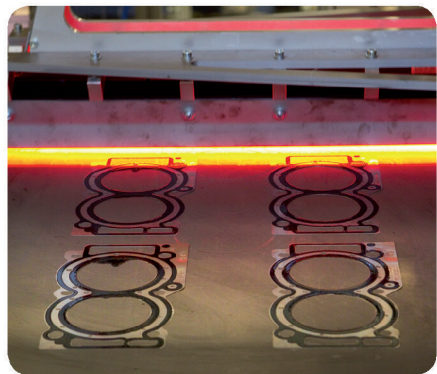

KONSTRUKCJA USZCZELKI STALOWO-ELASTOMEROWYCH

Uszczelnienie wysokowydajnych silników wysokoprężnych często wymaga specjalnej konstrukcji. Ciśnienia w komorze spalania są większe niż w silnikach o mniejszej wydajności, a oczekiwania dotyczące długości eksploatacji są dużo wyższe.

W tym segmencie rynku uszczelnień dominuje technologia stalowo-elastomerowa. Uszczelki często zawierają stalową płytkę, która jest specjalnie tłoczona wokół otworu cylindra. Jej zadaniem jest uszczelnienie komory spalania. Na płytce stalowej znajduje się warstwa uszczelki elastomerowej, która z kolei uszczelnia kanały, w których znajdują się cieczy. Ten rodzaj konstrukcji zapewnia stabilne i skuteczne uszczelnienie o doskonałych właściwościach w wysokich temperaturach.

W mniejszych silnikach występuje trend do zmniejszania wagi jednostki napędowej i zwiększania ilości mocy uzyskiwanej z danej objętości skokowej silnika, co wymaga bardziej zaawansowanych konstrukcyjnie uszczelki. Najnowsze uszczelki stalowo-elastomerowe zawierają wysokowydajne elastomery z układami uszczelnienia otworów, w których wykorzystano elementy odpowiedniego kształtowania powierzchni uszczelki, a także technologię MLS w celu uszczelnienia ciśnieni w komorze spalania przekraczających 250 barów.

USZCZELKI HTA™ (HIGH TEMPERATURE ALLOY – TECHNOLOGIA STOPU WYSOKOTEMPERATUROWEGO) – ZOSTAŁY WYRÓŻNIONE NAGRODĄ

Dążenia do uzyskiwania coraz większych mocy z coraz mniejszych pojemności skokowych skutkują wzrostem temperatury gazów wylotowych, co ma ogromny wpływ na uszczelnienie systemu wydechowego. By zaspokoić potrzeby producentów silników Federal-Mogul opracował nową technologię produkcji materiałów oraz nowe konstrukcje uszczelnień. Jedną z nich jest technologia HTA (wysokotemperaturowego stopu) – zapewniająca skokową poprawę w produkcji uszczelnień dla systemów wydechowych.

Ta nowa technologia, uhonorowana prestiżową nagrodą w zakresie innowacyjnych rozwiązań w przemyśle samochodowym - Automotive News PACE Award for Innovation 2007, zapewnia wyjątkową odporność termiczną i może funkcjonować w temperaturach dochodzących do 1000°C. To odkrycie było możliwe jedynie dzięki globalnemu doświadczeniu Federal-Mogul w zakresie materiałoznaw-

stwa, a konkretnie w chemii metali, powłok i powierzchni. Klienci Federal-Mogul na rynku części zamiennych korzystają z odkryć związanych z technologią HTA dzięki wprowadzaniu tych części do programu marki Payen.

USZCZELKI LEM® (LIQUID ELASTOMER MOULDING – FORMOWANIE PŁYNNEGO ELASTOMERU)

Wielki sukces uszczelki LEM był spowodowany tym, że pomogły one zrealizować wyjątkowe wymagania ze strony producentów silników w zakresie dużej elastyczności uszczelnień. Uszczelki typu LEM zostały wprowadzone na rynek w 1998 roku. Na montaż fabryczny silników oraz na rynek części zamiennych sprzedano już ponad 40 milionów uszczelki typu LEM.

Technologia ta jest również doskonałą technologią dla rynku części zamiennych. Uszczelki Payen LEM mają zdolność dostosowania się do o 30% większego odkształcenia powierzchni w porównaniu do innych, konkurencyjnych rozwiązań. Jest to tym bardziej ważne, że konstruktorzy silników stosują metale lekkie oraz mniejsze napięcia w śrubach mocujących. Ta technologia ma również wielką przyszłość w konstrukcjach jutra – ogniach paliwowych. Oczywiście i ten rodzaj uszczelnień stanie się częścią programu Payen na tym obiecującym, rozwijającym się rynku.

PAYEN DZIAŁA W NAJTRUDNIEJSZYCH WARUNKACH

Elementy uszczelnień jeszcze nigdy nie grały tak ogromnej roli w efektywności działania i niezawodności silników samochodowych. Wzrost ciśnienia w cylindrze, wzrost temperatur przy jednoczesnym obniżeniu wymiarów i masy silnika, spowodowały że nauka związana z uszczelnieniami stała się jedną z najbardziej skomplikowanych i wymagających dziedzin w obszarze konstrukcji silnika spalinowego. Wykorzystując niespotykane doświadczenie i wiedzę zarówno w obszarze dostaw na montaż fabryczny OE, jak i na rynek części zamiennych, Payen to PEWNOŚĆ W KAŻDYCH WARUNKACH, które można spotkać w przypadku jakiegokolwiek wyzwania, w jakimkolwiek samochodowym silniku. Podsumowując, Payen jest nowym standardem w technologii uszczelnień.



ЭФФЕКТИВНОСТЬ ПОД ДАВЛЕНИЕМ: НАСЛЕДИЕ КАЧЕСТВА И ИННОВАЦИЙ - PUYEN®

Инновации — двигатель автомобильной индустрии. Любой компонент современного легкового автомобиля или мощного коммерческого двигателя является результатом непрерывных поисков конструкторов и совершенствования производства. Тем не менее, немногие продукты изменились столь кардинально и столь инновационно, как уплотнительные элементы.

Когда речь заходит об инновационном дизайне прокладок, которые легко оставляют всех конкурентов позади как на рынке оригинального оборудования, так и на рынке запчастей, марка Puyen компании Federal-Mogul Corporation заслуженно занимает ведущее место.

Federal-Mogul – это ведущий мировой производитель прокладок для головок блока цилиндров и уплотнительных элементов оригинального оборудования. Лидерство на рынке оригинального оборудования означает, что каждая прокладка марки Puyen представляет собой результат новейших инновационных конструкторских разработок поистине мирового класса и внимательного изучения потребностей современных двигателей и производственных процессов, что гарантирует непревзойденное качество и эффективность.

Ассортимент продукции Puyen разрабатывается в четырех международных научных центрах, оснащенных новейшими технологиями и системами - это позволяет обеспечить сохранение и укрепление лидирующих позиций на рынке за счет предложения превосходных решений в сфере уплотнений.

200 ученых и инженеров работают над каждым элементом компонентов уплотнителей – от рецептуры материала до физического дизайна, также используются 26 испытательных стендов - для легких автомобильных и мощных коммерческих двигателей. Все это позволяет компании Federal-Mogul и марке Puyen обеспечивать идеальное решение для любой сложной задачи с использованием уплотнений.

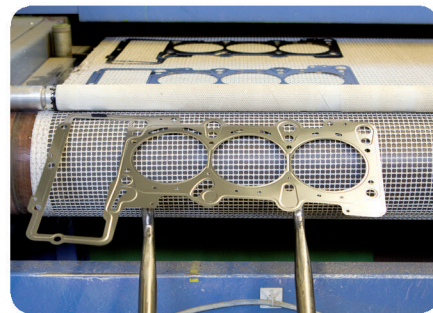
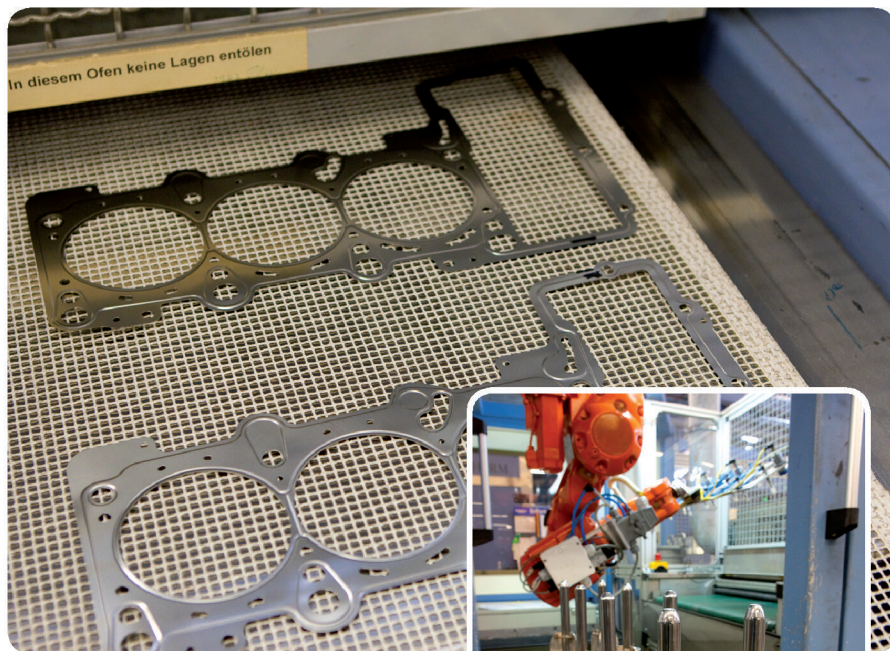

ЭФФЕКТИВНОСТЬ НА РЫНКЕ

Продукты Puyen производства Federal-Mogul «эффективны под давлением» самой требовательной бизнес-среды в мире: на рынке двигателей для легких и коммерческих автомобилей. Уникальная способность Federal-Mogul предлагать инновационные, сверхнадежные технологии уплотнений позволила построить прочные деловые связи с ведущими мировыми производителями. Центр Federal-Mogul Sealing Systems в городе Хердорф (Германия) играет важную роль в обслуживании тысяч покупателей из числа производителей оригинального оборудования и запасных частей. Это суперсовременное предприятие выпустило миллионы инновационных продуктов, в которых использовались технологии HTA (высокотемпературные сплавы), MLS (многослойная сталь) и LASPOT. Предприятие в Хердорфе прекрасно оснащено для решения проблем 21-го века: это обеспечивает лидерство Federal-Mogul в качестве и системах управления. В качестве признания этих и других достижений, компания Federal-Mogul Sealing Systems GmbH удостоилась престижной награды "TOP 100" Министерства экономики Германии.

ОТ КОНЦЕПЦИИ К ВОПЛОЩЕНИЮ: ЭФФЕКТИВНОСТЬ В КАЖДОЙ ДЕТАЛИ

Одной из самых сильных сторон команды Federal-Mogul из Хердорфа является приверженность постоянному совершенствованию и стремление изучать и проверять новые идеи – и при этом не упускать из виду потребностей каждого клиента. Используя инновационные материалы и конструкции в сочетании с новейшими производственными процессами, Federal-Mogul марка Puyen обеспечивают спрос в самых сложных областях и решают любые бизнес-задачи. Такое жесткое следование принципам качества и инноваций проявляется в каждом продукте Puyen. В качестве примера можно привести прокладку головки блока цилиндров LASPOT, разработанную инженерами Federal-Mogul по запросам потребителей. Требовалось создать конструкцию, в которой прокладка выполняет основную



уплотнительную функцию в областях применения с повышенным давлением сгорания. В каждой прокладке LASPOT используется новейшая технология, обеспечивая потребности самых требовательных дизельных двигателей. К другим отличительным чертам этих прокладок можно отнести функциональные слои, изготавливаемые из пружинной нержавеющей стали с каплеобразными выпуклостями разного размера, расположенными в соответствии с «закрытой» концепцией. Такой подход обеспечивает надежное уплотнение вдоль линейной зоны герметизации. Чтобы обеспечить исключительное микроуплотнение, все слои покрыты высококачественным, стабильным фторэластомером.

ПРОКЛАДКИ MLS (MULTI-LAYER STEEL - МНОГОСЛОЙНАЯ СТАЛЬ)

Компания Federal-Mogul является неоспоримым лидером в сфере технологий изготовления прокладок ГБЦ из многослойной стали уже почти 20 лет. Компания выпустила на предприятии в Хердорфе более 43 миллионов прокладок MLS для головок блоков цилиндров, при этом завод является также ведущим поставщиком для рынка запасных частей.

Такой успех в сегменте оригинального оборудования обусловлен, в частности, большим опытом Federal-Mogul в организации технологического процесса и независимостью в области технологий продуктов и инструментов. Инженеры Federal-Mogul находят и применяют наилучшие идеи и технологии, чтобы создавать оптимальные продукты для каждого двигателя - будь то прецизионная разработка и производство инструментов для проработки рельефа, выполнение самых жестких требований к покрытию прокладок или разработка высокоэффективного сварочного оборудования.

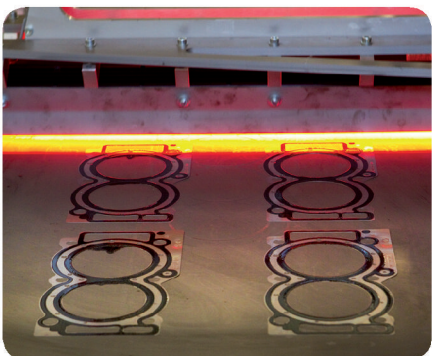

ПРОКЛАДКИ ИЗ СТАЛИ И ЭЛАСТОМЕРА

Для герметизации дизельных двигателей, предназначенных для тяжелых условий эксплуатации, часто требуется различный подход в конструировании. Давление при сгорании больше, чем в двигателях легковых автомобилей, а ожидания относительно долгосрочной эксплуатации намного выше. Преобладающим материалом на этом сегменте рынка является сталь с эластомером. Часто прокладки состоят из стальной пластины, выштампованной вокруг отверстия цилиндра для герметизации выделяющихся при горении газов, герметизация жидкостей достигается за счет применения эластомерных прокладок, обычно впрессованных в стальную пластину. Такая конструкция обеспечивает высокие стабильность и эффективность системы герметизации, а также великолепные герметизирующие свойства при высоких температурах. Как и в случае с двигателями меньшего размера, наблюдается тенденция по снижению веса двигателя с одновременным упрочнением его конструкции, а большая удельная мощность двигателя требует дальнейших усовершенствований конструкции прокладок. Самые современные конструкции с использованием стали и эластомера могут включать в себя высокоэффективные эластомеры с системами герметизации цилиндра, в которых для герметизации давлений свыше 250 бар, создаваемых при горении, могут применяться топографические элементы и технология MLS.

ОТМЕЧЕННЫЕ НАГРАДАМИ ПРОКЛАДКИ HTA™ (HIGH TEMPERATURE ALLOY - ВЫСОКОТЕМПЕРАТУРНЫЙ СПЛАВ)

Потребность в повышении мощности больших двигателей привела к увеличению температуры отработанных газов, что может отрицательно сказаться на прокладках системы выпуска. Чтобы помочь производителям двигателей решить эту проблему, компания Federal-Mogul разработала серию новых материалов и конструкций ГБЦ. Одно из таких решений - прокладка HTA (высокотемпературный сплав) - на порядок улучшает уплотнение отработавших газов.

Эта новая технология, удостоенная престижной награды Automotive News PACE Award for Innovation 2007, исключительно устойчива к тепловой деформации и способна выдерживать температуры до 1000°C. Инновационного прорыва компания Federal-Mogul добилась исключительно за счет огромного опыта в материаловедении, особенно в области металлов, покрытий и химии поверхностей. Клиенты Federal-Mogul на вторичном рынке уже получают огромные преимущества от технологии HTA за счет ее внедрения в производство деталей под маркой Rayen.



ПРОКЛАДКИ LEM® (LIQUID ELASTOMER MOULDING - ЛИТЬЕ ИЗ ЖИДКОГО ЭЛАСТОМЕРА)

Прокладки LEM производства Federal-Mogul прекрасно зарекомендовали себя при решении сложных задач уплотнения, встающих перед производителями комплектного оборудования, в частности, в шарнирах, требующих значительной гибкости. С момента появления в 1998 для рынков оригинального оборудования и послепродажного обслуживания было выпущено более 40 миллионов прокладок LEM. Прокладки LEM широко представлены в ассортименте продукции Rayen.

Эта технология прекрасно подходит для рынка запасных частей. Рельефные уплотнительные валики на прокладках LEM марки Rayen компенсируют деформацию фланцев на 30% большую, чем продукция конкурентов. Это особенно важно, поскольку проектировщики двигателей применяют облегченные фланцы и сниженные нагрузки на болты. Технология LEM пригодится и в завтрашних топливных элементах - и данные решения в области уплотнений войдут в ассортимент продукции Rayen по мере развития этого многообещающего рынка.

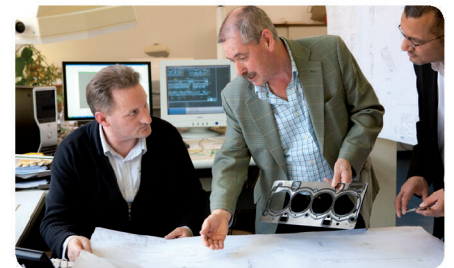

RAYEN ЭФФЕКТИВНОСТЬ ПОД ДАВЛЕНИЕМ

Уплотнительные элементы никогда ранее не были столь важны для повышения общей мощности и надежности автомобильных двигателей. Увеличение давления и температуры в цилиндрах, а также снижение массы двигателя превратили искусство уплотнения в одну из самых сложных и требовательных областей проектирования двигателя. Непревзойденный опыт на рынках как оригинального оборудования, так и запасных частей, позволяя изделиям под маркой Rayen ЭФФЕКТИВНОСТЬ ПОД ДАВЛЕНИЕМ практически в любом уплотнении автомобильного двигателя. Другими словами, компания Federal-Mogul марка Rayen - это новый стандарт в технологиях уплотнения.





الشفة بشكل كبير أكثر من الأساليب التكنولوجية المتنافسة. وهذه نقطة هامة؛ لأن مصممو المحرك يستخدمون شفافة خفيفة الوزن وحمولات خفيفة على مسامير الربط. كما تتناسب تكنولوجيا LEM مع خلايا الوقود التي ستستخدم في المستقبل وستصبح منتجات منع التسرب هذه جزءًا من ماركة Payen مع فتح هذه الأسواق الواعدة.



تعمل منتجات ماركة PAYEN تحت ضغط

لم تكن أبدًا مكونات منع التسرب أكثر أهمية من الأداء والكفاءة الكاملة في محركات السيارات. تسببت زيادة درجات حرارة وضغط الاسطوانة بالإضافة إلى قلة كتلة المحرك في جعل علم منع التسرب أحد أكثر المجالات تعقيدًا وطلبًا بالنسبة لتصميم المحرك. مع وجود مستوى منقطع النظر من الخبرة داخل أسواق المعدات الأصلية وقطع الغيار تعد Payen هي الماركة التي تتعامل تحت ضغط وذلك حقيقةً بالنسبة لأي خد لمنع التسرب في أي محرك سيارة. وبإختصار إن ماركة Payen هي المعيار الجديد في تكنولوجيا منع التسرب.

وكما هو الحال مع المحركات الأصغر هناك اتجاه لتصميم هياكل محرك أخف وذات قدرة حمل أكبر كما أن كثافات الطاقة الأعلى تتطلب المزيد من التطوير لتصميم الحشية. يمكن لأحدث تصاميم المطاط الصناعي الصلب أن تدمج المطاط الصناعي عالي الأداء مع أنظمة منع تسرب الثقب التي يمكن أن تستخدم العوامل الطبوغرافية وكذلك تكنولوجيا LEM لمنع تسرب ضغط الاحتراق لما يزيد عن 250 بار.

التي تتميز بمزيج من درجات الحرارة العالية (HTA™)

أدت الحاجة إلى الإخراج العالي من المحركات الأصغر إلى زيادة درجة حرارة العادم والتي قد يكون لها آثارًا ضارة على حشيات العادم. وللمساعدة محرك المعدات الأصلية في معالجة هذا الأمر. قامت شركة Federal-Mogul بتطوير مجموعة من أساليب التكنولوجيا وتصميمات منتج مادة الحشية الجديدة. إحدى هذه المجموعة - الحاشية التي تتميز بمزيج من درجات الحرارة العالية (HTA) - وهي تعتبر تطورًا إلى حد ما في منع تسرب غاز العادم.

تعد هذه التكنولوجيا الجديدة. الحائزة على جائزة Automotive News PACE Award للإبتكار مقاومة بشكل غير عادي لارتفاع درجات الحرارة ويمكنها مقاومة درجات الحرارة التي تصل إلى 1000 درجة مئوية. أصبح الإبتكار مكنًا فقط من خلال خبرة شركة Federal-Mogul العالية في علوم المواد. خاصةً في مجالات المعادن والدهانات وكيمياء السطح.

يجني عملاء ما بعد البيع التابعين لشركة Federal-Mogul فوائد تكنولوجيا HTA عن طريق تقديم القطع داخل مجموعة ماركة Payen.

حشيات (قالب المطاط الصناعي السائل) LEM®

ظلت حشيات LEM من شركة Federal-Mogul تحقق نجاحًا بالغًا في مساعدة مصنعي المعدات الأصلية على التغلب على تحديات منع التسرب الصعبة. خاصةً في الوصلات التي تتطلب مرونة كبيرة في التصميم.

تم تصنيع أكثر من 40 مليون حشية LEM من أجل OE وخدمات ما بعد البيع منذ أن تم صنع LEM في عام 1998. أصبحت حشيات LEM حاليًا من العناصر الثابتة في عرض مجموعة Payen.

تتناسب تلك التكنولوجيا وبشكل مثالي مع أسواق ما بعد البيع. تستطيع خزرات منع التسرب الطبوغرافية الموجودة على حشيات LEM من ماركة Payen استيعاب ما يصل إلى 30% من خريف

لمنع التسرب البسيط وغير العادي. تتم تبطين كافة الطبقات بمادة فلوروالاستومير عالية الدرجة والثابتة.

حشيات MLS (صلب متعدد الطبقات)

كانت ولا تزال شركة Federal-Mogul هي الشركة الرائدة بلا منازع في تكنولوجيا صناعة حشية الرأس (MLS) الصلب متعددة الطبقات لما يقرب من 20 عامًا. قامت الشركة بإنتاج أكثر من 43 مليون معدة أصلية وحشيات رأس MLS في هيردورف، كما يعد المصنع أيضًا الموفر الرائد في سوق قطع الغيار.

تحقق هذا النجاح في صناعة المعدات الأصلية نتيجة لما تتمتع به شركة Federal-Mogul من خبرة واستقلالية في صناعة المنتج وتكنولوجيا استخدام الآلات. سواءً كان مهتمًا بالتصميم عالي الدقة وتصنيع أدوات النقش. أو للبية متطلبات طلاء الحشية الشديدة أو تطوير معدات اللحام عالي الأداء من أجل تركيب السدادة. يعمل مهندسو بيدرالوجول في تطبيق أفضل الأفكار والتكنولوجيات لضمان الحصول على أفضل المنتجات لكل محرك.

تصاميم حشية المطاط الصناعي الصلب

تتطلب عملية منع تسرب محركات الديزل ذات الأداء العالي غالبًا إلى طريقة تصميم مختلفة. حيث يكون ضغط الاحتراق أكبر من ذلك الموجود في استخدامات المركبات الخفيفة وتكون احتمالات التحمل طويلة المدى أعلى بكثير.

تُعرف تكنولوجيا منع التسرب السائدة في هذا القطاع من السوق بالمطاط الصناعي الصلب. تتكون الحشيات غالبًا من لوحة صلبة تكون ملتفة حول منطقة الثقب لمنع تسرب غاز الاحتراق والحصول على مانع تسرب سائل عبر القيام بتشكيل موانع التسرب المطاطية على اللوحة الصلبة. يوفر هذا النوع من التصميم نظام منع تسرب عالي الكفاءة والثبات مع خصائص منع تسرب درجة حرارة عالية ممتازة.

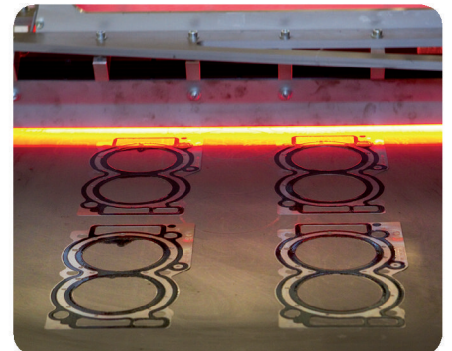

تعمل تحت ضغط: تاريخ من الجودة والابتكار يتمثل في ماركة PAYEN®

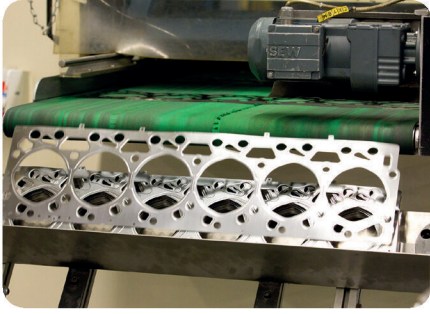

رائجة في أكثر أسواق الطلب العالمية

منتجات Payen من Federal-Mogul تعمل تحت الضغط في اقصى ظروف البيئة أعمال كثيرة المطالب في العالم: السيارات الصغيرة والمركبات التجارية سوق المحركات. قدرة Federal-Mogul الفريدة في تقديم تكنولوجيا منع تسرب مبتكرة و موثوقة بشكل كبير كانت هي الأداء التي جعلتها تحقق علاقات تجارية قوية مع الشركات الأولى على مستوى العالم في مجال تصنيع المعدات الأصلية.

منشأة أنظمة منع التسرب من بيديرالوجول في هيردورف، ألمانيا، تعلق دورًا رئيسيًا في تقديم الآلاف من المعدات الأصلية وخدمة ما بعد البيع العملاء. أدت هذه العملية للتطورة إلى إنتاج الملايين من منتجات مانع التسرب المبتكرة التي تتميز بـ HTA (سبيكة درجة حرارة عالية، وMLS (صلب متعدد الطبقات) وتكنولوجيا LASPOT. كما أن منشأة هيردورف مزودة بالمعدات اللازمة للتحديات التي يمكن أن نواجهها في القرن الواحد والعشرين وذلك عبر ريادة شركة بيديرالوجول في أنظمة الجودة والإدارة التقييدية. إكرامًا لكل الإنجازات الأخرى، تسلمت Federal-Mogul Sealing Systems GmbH جائزة «أفضل 100» المرموقة من وزارة العلاقات الاقتصادية الألمانية.

لريادة في كل جزء

يعد من بين عوامل القوة الرائدة لدى فريق مصنع هيردورف الالتزام باستمرار تحسين المستوى والإرادة في استكشاف وتوثيق الأفكار الجديدة - كل ذلك بجانب التركيز على احتياجات كل عميل على حدة. عن طريق استغلال المواد والتصميمات المبتكرة التي خضعت لأحدث العمليات، يمكن لشركة Federal-Mogul وماركتها Payen الوفاء بمتطلبات أي تطبيق والأهداف التجارية.

يمكنك أن ترى هذا التقدم المذهل في الجودة والابتكار في كافة منتجات ماركة Payen. وعلى سبيل المثال، قام مهندسو شركة Federal-Mogul بتطوير حشية رأس LASPOT® لمعالجة متطلبات العميل للتصميم الذي تمارس فيه السداة وظيفة منع التسرب الرئيسية بالنسبة لتطبيقات ضغط الاحتراق المتزايد. تتميز كل حشية رأس LASPOT بأحدث تكنولوجيا الصمام اللحوم للوفاء باحتياجات أكثر محركات الديزل طلبًا اليوم. والميزات الرئيسية الأخرى لتلك الحشيات هي الطبقات الوظيفية المصنوعة من الفولاذ المضاد للصدأ المنقوش بخزرات كاملة ومتوسطة مفهوم تم تطويره بشكل خاص "مغلقة" أو متوافقة مع الأدوات. تؤكد هذه الطريقة عملية منع التسرب القوية بطول منطقة التسرب الطولية. بالنسبة

الابتكار يقود إلى النجاح في مجال صناعة السيارات. ومع ذلك، فبينما تكون كل مكونات المركبة الخفيفة الحديثة والمحرك التجاري الذي يتحمل الأعمال الشاقة نتيجة للتطور المستمر في التصميم والتصنيع، إلا أن بعض المنتجات فقط هي ما تمثل طفرة في الصناعة - أو ابتكارًا عظيمًا - كمكونات منع التسرب.

عندما يتعلق الأمر بتقديم تصميمات مبتكرة للحشيات التي تزيد بشكل واضح من حدة المنافسة في كل من أسواق المعدات الأصلية وقطع الغيار فإن Payen إحدى شركات شركة Federal-Mogul تشغل مكانة منفردة.

إن Federal-Mogul هي أكبر شركة تصنيع لحشيات رأس اسطوانات المعدات الأصلية ومكونات منع التسرب في العالم. وتعني الريادة في صناعة هذه المعدات الأصلية أن جميع الحشيات التي تحمل ماركة Payen تكون نتيجة لعمليات بحث وتطوير رفيعة المستوى ونظرة شاملة لمتطلبات المحركات العصرية وعمليات التصنيع التي تضمن الجودة والأداء منقطعي النظر.

تقدم أربع مراكز للبحث والتطوير دعمها لمجموعة Payen: وكلٌ منها مزودًا بأحدث أساليب التكنولوجيا والأنظمة التي تضمن حفاظ تلك الماركة على ريادتها بل وانتشارها في السوق نظرًا لما تقدمه من منتجات عالية لمنع التسرب.

وبما أن لديها 200 عالم ومهندس يعملون جميعًا على معالجة كل عنصر من مكونات منع التسرب - بدءًا من تكوين المواد حتى التصميم المادي - إضافةً إلى امتلاكها 26 مركبة اختبار خاصة بالمركبات الخفيفة والمحركات التجارية، تقدم شركة Federal-Mogul وماركتها Payen الحل النموذجي لمواجهة منع التسرب.



**Certificate for the use of Federal-Mogul products
in the European Aftermarket according to
MV BER EC 461/ 2010 and respective Guidelines**









We hereby confirm, that the Federal-Mogul products using the brand names AE[®], ABEX[®], BERAL[®], CHAMPION[®], DURON[®], FERODO[®], FP DIESEL[®], GLYCO[®], GOETZE[®], MOOG[®], NECTO[®], NÜRAL[®], PAYEN[®], WAGNER[™] sold in the European Aftermarket fulfil the quality requirements applicable to the use of spare parts for repair or maintenance of motor vehicles by authorised repairers.

Date: 16/06/2010







Martin Hendricks
Vice President EMEA
Global Aftermarket
Federal-Mogul Corporation







 		 		 		 	
CUMMINS		MAN		MWM			
CY190	4	AH5450	114, 118, 120, 122, 124	AH5420	206		
EY190	4	DG640	102, 104	AH5460	206		
DAF		EG856		AH5490	206		
AH5370	14	EH5450	122	JH5172	207		
DW480	10	EH5451	118	NEW HOLLAND			
EW480	10	EV500	104, 108, 110	BL991	214		
NB956	13, 15	EV501	106, 110	NISSAN			
DEUTZ / KHD		GG85A		AE5940	216		
GM790	18	HL5070	113, 115, 117, 121, 123	VOLVO COMMERCIAL			
GM791	22	JD124	103, 105, 107, 109, 111	ET850	292		
JB188	19, 21	JJ490	103, 105, 107, 109, 111				
JD172	21, 23	NB964	103, 105				
JM869	19, 21	MERCEDES-BENZ					
NB934	21, 23	AH5390	176				
NB935	21, 23	AH5450	174, 176, 178, 180, 186, 188, 192, 194, 196, 198, 202				
FIAT COMMERCIAL		DZ141		182, 200			
BK490	32, 36	DZ142		182, 200			
BL991	34	DZ143		182, 200			
BW151	34, 36	EC521		182			
BY401	36	EC522		200			
HL5080	33, 37	EF5370		184, 186, 188, 190			
HL5081	37	ES411		158, 160			
IVECO		GG85F		202			
AG9360	72	HL5077		185, 187, 189, 191, 193			
BK490	76	JB162		149			
BL991	74, 76	JD297		151			
BW151	72, 74, 76	JD5086		183, 201			
BY401	72, 74	JH5072		183			
CG9360	72	JH5073		201			
CG9361	72	JH5094		155, 157			
FG9360	72	JH5095		169, 171, 173			
FG9361	72	JH5168		201			
HL5080	77	JJ280		175, 177, 179, 181			
HL5081	77	JM856		157, 159, 161			
JB188	63, 67	JM5186		183, 201			
JD172	71, 73, 77	JM5187		183, 201			
JD584	67	JM7095		155, 157			
JD5938	73	JN977		175, 177, 179, 181, 187, 189, 193, 195, 197, 199, 203			
JD5939	73	LB955		151, 153, 159, 161, 163, 165, 167, 169			
JH5169	73	NB977		173, 175, 177, 181			
JM869	63, 67	PB177		151, 159, 161, 173, 175			
JM7064	73						
NB934	71, 73, 77						
NB935	71, 73, 77						

NEW ENGINES LIST





Liste neu aufgenommenener Motoren • Liste des nouveaux moteurs
Elenco nuovi motori • Lista de nuevos motores





 CC	9		 CC	9	
DAF			IVECO		
NS 156	6240	4 10	8210.22X.523	13798	79 74
NS 177 M	6240	4 10	8210.22X.575	13798	79 74
NT 116	6240	4 10	8210.42M (TCA)	13798	84 74
NT 133	6240	4 10	BF4L 913 T	4086	11 62
PE 183 C	9200	11 10	BF6L 913	6128	36 66
PE 212 C	9200	11 10	BF6L 913 T	6128	36 66
PE 228 C	9200	11 10	BF6L 913/U	6128	36 66
PE 235 C	9200	11 10	BF8L 413 F	12763	67 70
PE 250 C	9200	11 10	BF8L 513	12763	67 70
PE 265 C	9200	11 10	F3A3681A	10300	58 70
PE 310 C	9200	11 10	F3A3681B	10300	58 70
PE 360 C	9200	11 10	F3A3681Y	10300	58 70
VF 373 M	14000	27 14	F3B3681A	12880	68 72
DEUTZ / KHD			F3B3681B	12880	68 72
BF 4M 2012	4038	3 18	F3B3681C	12880	68 72
BF 4M 2012 C	4038	3 18	F3B3681D	12880	68 72
BF 6M 2013	5702	13 18	F3B3681E	12880	68 72
BF 6M 2013 C	5702	13 18	F3B3681G	12880	68 72
F 6L 712	5104	9 18	F3BE 0681 A	12880	70 72
F 8L 513	13383	29 20	F3BE 0681 B	12880	69 72
F12L 513	20074	41 22	F3BE 0681 C	12880	69 72
FIAT COMMERCIAL			F3BE 0681 E	12880	69 72
8040.05.4990	3908	6 28	F3BE 0681 G	12880	69 72
8040.45.5200	3908	6 28	F3BE0681D	12882	74 72
8210.22.000	13798	43 34	F3BE3681A	12882	73 72
IVECO			F3BE3681B	12880	68 72
8060.04.055	5499	19 62	F3BE3681C	12880	68 72
8060.04.060	5500	24 64	F3BE3681D	12882	73 72
8060.04.070	5499	19 62	F3BE3681E	12882	73 72
8060.04.620	5499	19 62	F3BE3681F	12882	73 72
8060.04.621	5499	19 62	F3BE3681G	12882	73 72
8060.04.630	5500	23 64	F4L 913	4086	11 62
8060.04.639	5500	23 64	F6L 913	6128	36 66
8060.04.658	5499	19 62	MAN		
8060.04.660	5500	24 64	D 0224 M	3790	1 102
8060.04.669	5500	24 64	D 0224 ME	3790	1 102
8060.04.670	5500	23 64	D 0226 M	5687	7 104
8060.04.672	5500	23 64	D 0226 MC	5687	7 104
8060.04.675	5500	23 64	D 0226 ME	5687	7 104
8060.04.689	5500	24 64	D 0226 MFA	5687	7 104
8060.24.601	5500	25 64	D 0226 MFM	5687	7 104
8060.24.670	5499	20 62	D 0226 MFO	5687	7 104
8060.24.671	5499	20 62	D 0226 MH	5687	7 104
8060.24.678	5500	25 64	D 0226 MK	5687	7 104
8210.02.067	13798	78 74	D 0226 MKFA	5687	7 104
8210.02.069	13798	78 74	D 0226 MKFO	5687	7 104
8210.02.371	13798	78 74	D 0226 MKH	5687	7 104
8210.02.373	13798	78 74	D 0226 ML	5687	7 104
8210.02.377	13798	78 74	D 0226 MLE	5687	7 104
8210.02.393	13798	78 74	D 0226 MT	5687	7 104
8210.02.440	13798	78 74	D 0226 MTE	5687	7 104
8210.02.441	13798	78 74	D 0834 LFL04	4581	5 102
8210.02.731	13798	78 74	D 0834 LFL20	4580	2 102
8210.22X.069	13798	79 74	D 0834 LFL40	4581	6 104
8210.22X.235	13798	79 74	D 0834 LFL41	4581	6 104

 CC	9		 CC	9	
MAN			MERCEDES-BENZ		
D 0834 LFL42	4581	6 104	OM 326.911	10809	50 176
D 0834 LFL50	4581	6 104	OM 326.912	10809	50 176
D 0834 LFL51	4581	6 104	OM 326.914	10809	50 176
D 0834 LFL52	4581	6 104	OM 326.915	10809	50 176
D 0834 LFL53	4581	6 104	OM 326.918	10809	50 176
D 0834 LFL54	4581	6 104	OM 326.971	10809	50 176
D 0834 LFL55	4581	6 104	OM 326.972	10809	50 176
D 0834 LOH50	4581	6 104	OM 326.973	10809	50 176
D 0834 LOH51	4581	6 104	OM 326.974	10809	50 176
D 0834 LOH52	4581	6 104	OM 326.975	10809	50 176
D 0834 LOH53	4581	6 104	OM 326.977	10809	50 176
D 2156 HM 2	10344	33 114	OM 326.980	10809	50 176
D 2156 HNY	10344	33 114	OM 326.983	10809	50 176
D 2156 MGN	10344	33 114	OM 326.988	10809	50 176
D 2156 MNY	10344	33 114	OM 327.910	7980	42 172
D 2156 MTX	10344	33 114	OM 327.918	7980	42 172
D 2156 MY	10344	33 114	OM 327.919	7980	42 172
D 2156 MYN	10344	33 114	OM 327.934	7980	42 172
D 2876 LF03	12816	51 122	OM 327.935	7980	42 172
D 2876 LF04	12816	51 122	OM 327.936	7980	42 172
D 2876 LF05	12816	51 122	OM 327.937	7980	42 172
D 2876 LF06	12816	51 122	OM 327.938	7980	42 172
D 2876 LF07	12816	51 122	OM 327.939	7980	42 172
D 2876 LF11	12816	51 122	OM 327.940	7980	42 172
D 2876 LF12	12816	52 122	OM 327.941	7980	42 172
D 2876 LF13	12816	52 122	OM 327.943	7980	42 172
D 2876 LF25	12816	52 122	OM 327.944	7980	42 172
D 2876 LOH01	12816	51 122	OM 327.945	7980	42 172
D 2876 LOH02	12816	51 122	OM 327.946	7980	42 172
D 2876 LOH03	12816	51 122	OM 344.913	5673	28 160
D 2876 LOH20	12816	52 122	OM 344.937	5673	28 160
D 2876 LOH21	12816	52 122	OM 344.938	5673	28 160
E 2866 DF02	11967	39 118	OM 344.939	5673	28 160
E 2866 DF03	11967	39 118	OM 344.940	5673	28 160
E 2866 DF04	11967	39 118	OM 344.948	5673	28 160
E 2866 DOH02	11967	39 118	OM 344.949	5673	28 160
E 2866 DOH03	11967	39 118	OM 344.951	5673	28 160
E 2866 DOH04	11967	39 118	OM 344.952	5673	28 160
E 2866 DUH03	11967	39 118	OM 346.910	10809	51 176
E 2866 LUH02	11967	45 120	OM 346.913	10809	51 176
MERCEDES-BENZ			OM 346.914	10809	51 176
M 476.920	11967	70 188	OM 346.915	10809	51 176
M 476.921	11967	70 188	OM 346.917	10809	51 176
M 476.925	11967	70 188	OM 346.941	10809	51 176
M 476.926	11967	70 188	OM 346.942	10809	51 176
M 476.927	11967	70 188	OM 346.943	10809	51 176
M 476.930	11967	70 188	OM 346.944	10809	51 176
M 476.932	11967	70 188	OM 346.945	10809	51 176
M 476.933	11967	70 188	OM 346.946	10809	51 176
M 476.934	11967	70 188	OM 346.952	10809	51 176
M 476.935	11967	70 188	OM 346.953	10809	51 176
M 906.900	6374	40 172	OM 354.926	3972	19 152
M 906.901	6374	40 172	OM 356.912	5958	32 164
M 906.903	6374	40 172	OM 356.913	5958	30 162
OM 326.910	10809	50 176	OM 356.915	5958	30 162

NEW ENGINES LIST





Liste neu aufgenommenener Motoren • Liste des nouveaux moteurs
Elenco nuovi motori • Lista de nuevos motores





 CC	9		 CC	9	
MERCEDES-BENZ			MERCEDES-BENZ		
OM 356.916	5958	33 164	OM 360.986	8725	43 174
OM 356.952	5958	33 164	OM 376.905	5958	30 162
OM 356.958	5958	30 162	OM 376.906	5958	30 162
OM 356.959	5958	33 164	OM 376.907	5958	30 162
OM 356.977	5958	35 166	OM 376.908	5958	30 162
OM 356.978	5958	30 162	OM 376.909	5958	30 162
OM 356.988	5958	35 166	OM 376.910	5958	30 162
OM 357.904	5958	30 162	OM 376.930	5958	30 162
OM 357.912	5958	32 164	OM 376.941	5958	35 166
OM 357.913	5958	32 164	OM 376.945	5958	35 166
OM 357.924	5958	36 168	OM 376.946	5958	35 166
OM 357.926	5958	35 166	OM 376.947	5958	35 166
OM 357.931	5958	35 166	OM 376.950	5958	35 166
OM 357.936	5958	35 166	OM 376.951	5958	35 166
OM 357.937	5958	35 166	OM 376.952	5958	35 166
OM 357.938	5958	35 166	OM 376.953	5958	35 166
OM 357.945	5958	36 168	OM 376.954	5958	35 166
OM 357.949	5958	35 166	OM 376.955	5958	35 166
OM 360.935	8725	43 174	OM 376.956	5958	35 166
OM 360.936	8725	43 174	OM 376.957	5958	35 166
OM 360.937	8725	43 174	OM 376.958	5958	35 166
OM 360.938	8725	43 174	OM 376.961	5958	35 166
OM 360.940	8725	43 174	OM 376.962	5958	35 166
OM 360.941	8725	43 174	OM 376.963	5958	35 166
OM 360.942	8725	43 174	OM 376.964	5958	35 166
OM 360.943	8725	43 174	OM 376.967	5958	35 166
OM 360.944	8725	43 174	OM 376.968	5958	35 166
OM 360.946	8725	43 174	OM 376.969	5958	35 166
OM 360.948	8725	43 174	OM 376.970	5958	35 166
OM 360.949	8725	43 174	OM 376.972	5958	35 166
OM 360.950	8725	43 174	OM 376.975	5958	35 166
OM 360.951	8725	43 174	OM 376.976	5958	35 166
OM 360.952	8725	43 174	OM 376.977	5958	35 166
OM 360.960	8725	43 174	OM 376.980	5958	35 166
OM 360.961	8725	43 174	OM 376.981	5958	35 166
OM 360.962	8725	43 174	OM 376.982	5958	35 166
OM 360.963	8725	43 174	OM 376.984	5958	35 166
OM 360.964	8725	43 174	OM 376.986	5958	35 166
OM 360.965	8725	43 174	OM 376.987	5958	35 166
OM 360.966	8725	43 174	OM 376.988	5958	35 166
OM 360.967	8725	43 174	OM 376.989	5958	35 166
OM 360.968	8725	43 174	OM 376.993	5958	35 166
OM 360.969	8725	43 174	OM 376.994	5958	35 166
OM 360.970	8725	43 174	OM 376.995	5958	35 166
OM 360.971	8725	43 174	OM 376.997	5958	35 166
OM 360.972	8725	43 174	OM 376.998	5958	35 166
OM 360.973	8725	43 174	OM 376.999	5958	35 166
OM 360.975	8725	43 174	OM 380.940	3972	20 152
OM 360.979	8725	43 174	OM 380.942	3972	20 152
OM 360.980	8725	43 174	OM 380.943	3972	20 152
OM 360.981	8725	43 174	OM 382.912	5958	30 162
OM 360.982	8725	43 174	OM 382.913	5958	30 162
OM 360.983	8725	43 174	OM 382.916	5958	34 164
OM 360.984	8725	43 174	OM 382.917	5958	34 164
OM 360.985	8725	43 174	OM 382.919	5958	30 162

 CC	9		 CC	9	
MERCEDES-BENZ			MERCEDES-BENZ		
OM 382.950	5958	34 164	OM 457.929	11967	65 184
OM 382.970	5958	35 166	OM 457.931	11967	65 184
OM 382.971	5958	30 162	OM 457.932	11967	59 184
OM 384.907	3972	20 152	OM 457.933	11967	72 188
OM 384.908	3972	20 152	OM 457.934	11967	72 188
OM 386.906	5958	30 162	OM 457.935	11967	72 188
OM 386.950	5958	35 166	OM 457.936	11967	66 186
OM 386.951	5958	35 166	OM 457.937	11967	76 190
OM 386.952	5958	35 166	OM 457.938	11967	72 188
OM 386.980	5958	35 166	OM 457.939	11967	66 186
OM 386.981	5958	35 166	OM 457.940	11967	66 186
OM 386.983	5958	35 166	OM 457.941	11967	73 188
OM 409.906	9204	44 174	OM 457.942	11967	73 188
OM 409.907	9204	44 174	OM 457.943	11967	74 190
OM 409.908	9204	44 174	OM 457.944	11967	74 190
OM 440.905	15080	88 198	OM 457.945	11967	66 186
OM 440.906	15080	88 198	OM 457.946	11967	66 186
OM 440.907	15080	88 198	OM 457.947	11967	76 190
OM 440.908	15080	88 198	OM 457.948	11967	61 184
OM 440.910	15080	88 198	OM 457.949	11967	66 186
OM 440.911	15080	88 198	OM 457.950	11967	75 190
OM 440.912	15080	88 198	OM 457.951	11967	61 184
OM 440.943	14618	87 196	OM 457.952	11967	75 190
OM 440.945	14618	87 196	OM 457.953	11967	61 184
OM 440.948	14618	87 196	OM 457.954	11967	75 190
OM 440.949	14618	87 196	OM 457.955	11967	79 190
OM 440.972	14618	87 196	OM 457.956	11967	80 190
OM 440.974	14618	87 196	OM 457.957	11967	81 190
OM 440.986	14618	87 196	OM 457.958	11967	81 190
OM 440.987	14618	87 196	OM 457.959	11967	75 190
OM 440.988	14618	87 196	OM 457.960	11967	82 192
OM 440.989	14618	87 196	OM 457.961	11967	61 184
OM 445.934	10964	53 178	OM 457.962	11967	61 184
OM 445.935	10964	53 178	OM 457.964	11967	75 190
OM 446.923	14618	87 196	OM 457.965	11967	75 190
OM 446.934	14618	87 196	OM 457.966	11967	75 190
OM 446.935	14618	87 196	OM 458.960	11967	77 190
OM 446.938	14618	87 196	OM 458.970	11967	78 190
OM 446.941	14618	87 196	OM 458.980	11967	78 190
OM 446.944	14618	87 196	OM 460.950	12816	85 192
OM 446.947	14618	87 196	OM 460.960	12816	85 192
OM 457.914	11967	59 184	OM 481.902	10964	52 178
OM 457.915	11967	60 184	OM 481.904	10964	52 178
OM 457.916	11967	59 184	OM 482.912	14618	86 194
OM 457.917	11967	61 184	OM 482.930	14618	86 194
OM 457.918	11967	61 184	OM 482.940	14618	86 194
OM 457.919	11967	62 184	OM 482.941	14618	86 194
OM 457.920	11967	59 184	OM 489.960	9973	48 176
OM 457.922	11967	63 184	OM 489.961	9973	48 176
OM 457.923	11967	59 184	OM 521.940	11946	58 182
OM 457.924	11967	64 184	OM 521.950	11946	58 182
OM 457.925	11967	65 184	OM 522.941	15928	89 200
OM 457.926	11967	65 184	OM 522.942	15928	89 200
OM 457.927	11967	59 184	OM 522.943	15928	89 200
OM 457.928	11967	64 184	OM 522.950	15928	89 200

NEW ENGINES LIST





Liste neu aufgenommenener Motoren • Liste des nouveaux moteurs
Elenco nuovi motori • Lista de nuevos motores

 CC	9		 CC	9	
MERCEDES-BENZ			MERCEDES-BENZ		
OM 541.928	11946	58 182	OM 900.922	4249	23 156
OM 541.940	11946	58 182	OM 902.910	6374	38 168
OM 541.941	11946	58 182	OM 902.911	6374	38 168
OM 541.942	11946	58 182	OM 902.912	6374	38 168
OM 541.943	11946	58 182	OM 902.913	6374	38 168
OM 541.944	11946	58 182	OM 902.914	6374	38 168
OM 541.945	11946	58 182	OM 902.915	6374	38 168
OM 541.946	11946	58 182	OM 902.916	6374	38 168
OM 541.947	11946	58 182	OM 902.917	6374	38 168
OM 541.948	11946	58 182	OM 902.918	6374	38 168
OM 541.949	11946	58 182	OM 902.919	6374	38 168
OM 541.950	11946	58 182	OM 902.920	6374	38 168
OM 541.951	11946	58 182	OM 902.921	6374	38 168
OM 541.952	11946	58 182	OM 902.922	6374	38 168
OM 541.970	11946	58 182	OM 902.923	6374	38 168
OM 541.971	11946	58 182	OM 902.927	6374	38 168
OM 541.972	11946	58 182	OM 902.930	6374	38 168
OM 541.973	11946	58 182	OM 902.931	6374	38 168
OM 541.974	11946	58 182	OM 902.932	6374	38 168
OM 541.975	11946	58 182	OM 902.933	6374	38 168
OM 541.976	11946	58 182	OM 904.904	4249	21 154
OM 541.977	11946	58 182	OM 904.909	4249	21 154
OM 541.978	11946	58 182	OM 904.910	4249	21 154
OM 541.980	11946	58 182	OM 904.911	4249	21 154
OM 541.981	11946	58 182	OM 904.912	4249	21 154
OM 542.940	15928	89 200	OM 904.914	4249	21 154
OM 542.941	15928	89 200	OM 904.915	4249	21 154
OM 542.942	15928	89 200	OM 904.916	4249	21 154
OM 542.943	15928	89 200	OM 904.917	4249	21 154
OM 542.944	15928	89 200	OM 904.918	4249	21 154
OM 542.945	15928	89 200	OM 904.919	4249	21 154
OM 542.947	15928	89 200	OM 904.920	4249	21 154
OM 542.948	15928	89 200	OM 904.921	4249	21 154
OM 542.956	15928	89 200	OM 904.922	4249	21 154
OM 542.957	15928	89 200	OM 904.923	4249	21 154
OM 542.960	15928	89 200	OM 904.924	4249	21 154
OM 542.961	15928	89 200	OM 904.925	4249	21 154
OM 542.962	15928	89 200	OM 904.926	4249	21 154
OM 542.963	15928	89 200	OM 904.927	4249	21 154
OM 542.964	15928	89 200	OM 904.928	4249	21 154
OM 602.938	2497	10 148	OM 904.929	4249	21 154
OM 602.981	2874	15 150	OM 904.930	4249	21 154
OM 602.983	2874	14 148	OM 904.931	4249	21 154
OM 602.989	2874	15 150	OM 904.932	4249	21 154
OM 602.991	2874	11 148	OM 904.933	4249	21 154
OM 602.994	2874	13 148	OM 904.934	4249	21 154
OM 900.910	4249	23 156	OM 904.935	4249	21 154
OM 900.911	4249	22 154	OM 904.936	4249	21 154
OM 900.912	4249	22 154	OM 904.937	4249	21 154
OM 900.913	4249	22 154	OM 904.938	4249	21 154
OM 900.917	4249	23 156	OM 904.939	4249	21 154
OM 900.918	4249	23 156	OM 904.940	4249	21 154
OM 900.919	4249	23 156	OM 904.941	4249	21 154
OM 900.920	4249	23 156	OM 904.942	4249	21 154
OM 900.921	4249	23 156	OM 904.943	4249	21 154

 CC	9		 CC	9	
MERCEDES-BENZ			MERCEDES-BENZ		
OM 904.944	4249	21 154	OM 906.945	6374	39 170
OM 904.945	4249	21 154	OM 906.946	6374	39 170
OM 904.946	4249	21 154	OM 906.947	6374	39 170
OM 904.947	4249	21 154	OM 906.948	6374	39 170
OM 904.948	4249	21 154	OM 906.949	6374	39 170
OM 904.949	4249	21 154	OM 906.950	6374	39 170
OM 904.950	4249	21 154	OM 906.951	6374	39 170
OM 904.951	4249	21 154	OM 906.952	6374	39 170
OM 904.952	4249	21 154	OM 906.953	6374	39 170
OM 904.953	4249	21 154	OM 906.954	6374	39 170
OM 904.954	4249	21 154	OM 906.955	6374	39 170
OM 904.955	4249	21 154	OM 906.956	6374	39 170
OM 904.956	4249	21 154	OM 906.957	6374	39 170
OM 904.957	4249	21 154	OM 906.958	6374	39 170
OM 904.959	4249	21 154	OM 906.959	6374	39 170
OM 904.961	4249	21 154	OM 906.960	6374	39 170
OM 904.962	4249	21 154	OM 906.961	6374	39 170
OM 904.964	4249	21 154	OM 906.962	6374	39 170
OM 904.965	4249	21 154	OM 906.963	6374	39 170
OM 904.966	4249	21 154	OM 906.964	6374	39 170
OM 904.967	4249	21 154	OM 906.965	6374	39 170
OM 904.968	4249	21 154	OM 906.966	6374	39 170
OM 906.910	6374	39 170	OM 906.967	6374	39 170
OM 906.911	6374	39 170	OM 906.968	6374	39 170
OM 906.912	6374	39 170	OM 906.970	6374	39 170
OM 906.913	6374	39 170	OM 906.971	6374	39 170
OM 906.914	6374	39 170	OM 906.974	6374	39 170
OM 906.915	6374	39 170	OM 906.975	6374	39 170
OM 906.916	6374	39 170	OM 906.976	6374	39 170
OM 906.917	6374	39 170	OM 906.977	6374	39 170
OM 906.918	6374	39 170	OM 906.978	6374	39 170
OM 906.919	6374	39 170	OM 906.979	6374	39 170
OM 906.920	6374	39 170	OM 906.980	6374	39 170
OM 906.921	6374	39 170	OM 906.981	6374	39 170
OM 906.922	6374	39 170	OM 906.982	6374	39 170
OM 906.923	6374	39 170	OM 906.983	6374	39 170
OM 906.924	6374	39 170	OM 906.985	6374	39 170
OM 906.925	6374	39 170	OM 906.988	6374	39 170
OM 906.926	6374	39 170	OM 907.910	4249	21 154
OM 906.927	6374	39 170	OM 907.920	4249	21 154
OM 906.928	6374	39 170	OM 907.930	4249	21 154
OM 906.929	6374	39 170	OM 907.940	4249	21 154
OM 906.930	6374	39 170	OM 907.941	4249	21 154
OM 906.931	6374	39 170	OM 907.960	4249	21 154
OM 906.932	6374	39 170	OM 907.970	4249	21 154
OM 906.933	6374	39 170	OM 907.980	4249	21 154
OM 906.934	6374	39 170	OM 907.990	4249	21 154
OM 906.935	6374	39 170	OM 909.900	6374	39 170
OM 906.936	6374	39 170	OM 909.901	6374	39 170
OM 906.937	6374	39 170	OM 909.910	6374	39 170
OM 906.938	6374	39 170	OM 909.911	6374	39 170
OM 906.939	6374	39 170	OM 909.920	6374	39 170
OM 906.940	6374	39 170	OM 909.921	6374	39 170
OM 906.941	6374	39 170	OM 909.960	6374	39 170
OM 906.944	6374	39 170	OM 909.970	6374	39 170

NEW ENGINES LIST

Liste neu aufgenommenener Motoren • Liste des nouveaux moteurs
Elenco nuovi motori • Lista de nuevos motores

 CC	9		 CC	9	
MERCEDES-BENZ			MERCEDES-BENZ		
OM 909.971	6374	39	170	OM 942.960	15928 89 200
OM 924.910	4801	25	156	OM 942.967	15928 89 200
OM 924.911	4801	25	156	OM 942.970	15928 89 200
OM 924.912	4801	25	156	OM 942.980	15928 89 200
OM 924.914	4801	25	156	OM 942.990	15928 89 200
OM 924.915	4801	25	156	MWM	
OM 924.916	4801	25	156	D 327-6	5654 8 206
OM 924.917	4801	25	156	OM	
OM 924.919	4801	25	156	CO 3	4941 6 218
OM 924.920	4801	26	156	CO 3/41..	4560 3 218
OM 924.922	4801	26	156	VOLVO COMMERCIAL	
OM 924.923	4801	25	156	D10A360	9600 39 290
OM 924.924	4801	25	156	D12A340	12100 50 292
OM 926.910	7201	41	172	D12C340	12100 50 292
OM 926.911	7201	41	172	D12C380	12100 50 292
OM 926.912	7201	41	172	D12C420	12100 50 292
OM 926.913	7201	41	172	D12C460	12100 50 292
OM 926.914	7201	41	172	D12D340	12100 50 292
OM 926.915	7201	41	172	D12D380	12100 50 292
OM 926.916	7201	41	172	D12D420	12100 50 292
OM 926.917	7201	41	172	D12D460	12100 50 292
OM 926.918	7201	41	172	D12D500	12100 50 292
OM 926.919	7201	41	172	D7C215	7300 21 288
OM 926.920	7201	41	172	D7C250	7300 21 288
OM 926.921	7201	41	172	D7C290	7300 21 288
OM 926.924	7201	41	172	D7C310	7300 21 288
OM 926.925	7201	41	172		
OM 926.926	7201	41	172		
OM 926.927	7201	41	172		
OM 926.928	7201	41	172		
OM 926.929	7201	41	172		
OM 926.930	7201	41	172		
OM 926.932	7201	41	172		
OM 926.934	7201	41	172		
OM 926.935	7201	41	172		
OM 926.937	7201	41	172		
OM 926.938	7201	41	172		
OM 926.939	7201	41	172		
OM 941.910	11946	58	182		
OM 941.920	11946	58	182		
OM 941.921	11946	58	182		
OM 941.929	11946	58	182		
OM 941.930	11946	58	182		
OM 941.940	11946	58	182		
OM 941.960	11946	58	182		
OM 941.970	11946	58	182		
OM 941.980	11946	58	182		
OM 941.981	11946	58	182		
OM 941.990	11946	58	182		
OM 942.900	15928	89	200		
OM 942.910	15928	89	200		
OM 942.911	15928	89	200		
OM 942.912	15928	89	200		
OM 942.925	15928	89	200		
OM 942.930	15928	89	200		

BEDFORD



cc







Ø

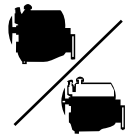

kW/PS

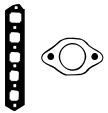

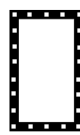
1	220	3614	4	103.19		48-52/ 65-71	AH940 (Steel) Eng.TJ264039→ Eng.TK181074→	CH940 ■○ Eng.TJ264039→ Eng.TK181074→	EF031
2	330	5420	6	103.19	Turbo	72-99/ 98-135	AH870 (Steel) BN110 (Fibre)	CH871 ■○ (Steel) DN110 ■○ (Fibre)	ED462
3	500 PHASE I	8200	6	115.88			BL150 (Fibre)		EC220
4	500 PHASE II	8200	6	115.88			BL160 (Fibre)	DL160 ○	EC220

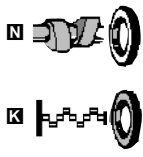
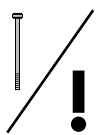
					
				<input checked="" type="checkbox"/> KT632 <input checked="" type="checkbox"/> (x2)	
<input checked="" type="checkbox"/> JE212	JM258	JJ118	KG431 (x2)	<input checked="" type="checkbox"/> KT632 <input checked="" type="checkbox"/> (x2)	
<input checked="" type="checkbox"/> JE212	JM475	JJ119			
	JM475	JJ119		<input checked="" type="checkbox"/> NB460 <input checked="" type="checkbox"/> 133.4x158.8x12.7mm, MVQ Eng.7420100 →	



AH870

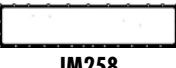

JM258



AH940



JM475



BL150, BL160



JJ118

BN110



JE212

CUMMINS







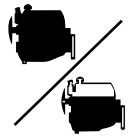

cc



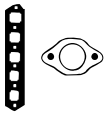

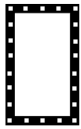

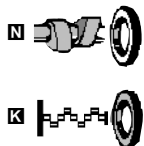
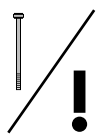



kW/PS



1	4 BTA 3.9	3922	4	102.00	Euro 2/Turbo Intercooled	57-97/ 78-132	AY190 (Fibre)	CY190	EY190
	4 BT	3922	4	102.00	Turbo	81/110			
	4 BTAA	3922	4	102.00	Turbo Intercooled	103/140			
2	6 BT5.9	5880	6	102.00	Turbo	108/147	BW530 (Fibre)	DW531	EW531
	6 BTA-5.9	5880	6	102.00	Turbo Intercooled	118/160			
3	6 B5.9	5883	6	102.00		85/115	BW530 (Fibre)	DW531	EW531

						 <p data-bbox="1236 107 1308 134">BW530</p>

		cc			9			cc			9
DA 475	Diesel	4770	6	100.62	1	RS 222 M	Diesel	8650	6	118.00	10
DD 575	Diesel	5750	6	100.00	2	VF 373 M	Diesel	14000	6	140.00	27
DF 615	Diesel	6150	6	104.18	3	WS 222 G	Diesel	11630	6	130.00	24
DH 825	Diesel	8250	6	118.00	5	WS 222 L	Diesel	11630	6	130.00	25
DHB 825	Diesel	8250	6	118.00	5	WS 222 M	Diesel	11630	6	130.00	24
DHR 825	Diesel	8250	6	118.00	5	WS 225	Diesel	11600	6	130.00	15
DHS 825	Diesel	8250	6	118.00	6	WS 225 ATi	Diesel	11630	6	130.00	25
DHS 825SM	Diesel	8250	6	118.00	6	WS 242	Diesel	11600	6	130.00	15
DHT 825	Diesel	8250	6	118.00	8	WS 242 L	Diesel	11600	6	130.00	15
DHTD 825	Diesel	8250	6	118.00	6	WS 242 M	Diesel	11600	6	130.00	15
DHU 825	Diesel	8250	6	118.00	7	WS 259	Diesel	11600	6	130.00	15
DK 1160	Diesel	11630	6	130.00	22	WS 259 ATi	Diesel	11630	6	130.00	25
DKA 1160	Diesel	11600	6	130.00	13	WS 268	Diesel	11600	6	130.00	15
DKB 1160	Diesel	11600	6	130.00	13	WS 268 G	Diesel	11600	6	130.00	15
DKCL 1160	Diesel	11630	6	130.00	21	WS 268 L	Diesel	11600	6	130.00	15
DKD 1160	Diesel	11630	6	130.00	20	WS 268 M	Diesel	11600	6	130.00	15
DKDL 1160	Diesel	11630	6	130.00	20	WS 270	Diesel	11630	6	130.00	24
DKFL 1160	Diesel	11630	6	130.00	21	WS 282	Diesel	11600	6	130.00	15
DKL 1160	Diesel	11630	6	130.00	20	WS 282 ATi	Diesel	11630	6	130.00	25
DKS 1160	Diesel	11600	6	130.00	14	WS 282 L	Diesel	11630	6	130.00	25
DKS 1160 E	Diesel	11600	6	130.00	14	WS 295	Diesel	11600	6	130.00	15
DKSB 1160	Diesel	11630	6	130.00	21	WS 295 G	Diesel	11600	6	130.00	15
DKSE 1160	Diesel	11630	6	130.00	21	WS 295 L	Diesel	11600	6	130.00	15
DKT 1160	Diesel	11600	6	130.00	14	WS 295 M	Diesel	11600	6	130.00	15
DKTD 1160	Diesel	11600	6	130.00	14	WS 295 M Ati	Diesel	11627	6	130.00	19
DKTL 1160	Diesel	11600	6	130.00	14	WS 315	Diesel	11600	6	130.00	15
DKV 1160	Diesel	11600	6	130.00	14	WS 315 G	Diesel	11627	6	130.00	19
DKVL 1160	Diesel	11600	6	130.00	14	WS 315 L	Diesel	11600	6	130.00	15
DKX 1160	Diesel	11600	6	130.00	14	WS 315 M	Diesel	11600	6	130.00	15
DKX 1160 ATi	Diesel	11600	6	130.00	14	XF 250 M	Diesel	12580	6	130.00	26
DKXE 1160	Diesel	11600	6	130.00	14	XF 280 M	Diesel	12580	6	130.00	26
DKXE 1160 ATi	Diesel	11630	6	130.00	21	XF 315 M	Diesel	12580	6	130.00	26
DKZ 1160 ATi	Diesel	11600	6	130.00	14	XF 355 M	Diesel	12580	6	130.00	26
DKZ 1160 ATJ	Diesel	11627	6	130.00	16						
DKZE 1160	Diesel	11600	6	130.00	14						
DNS 620	Diesel	6240	6	104.18	4						
DNT 620	Diesel	6240	6	104.18	4						
DNTD 620	Diesel	6240	6	104.18	4						
DT 615	Diesel	6150	6	104.18	3						
DTD 615	Diesel	6150	6	104.18	3						
DU 825	Diesel	8250	6	118.00	7						
HS 825	Diesel	8250	6	118.00	9						
HT 825	Diesel	8250	6	118.00	9						
KT 191	Diesel	11627	6	130.00	18						
LT 160	Diesel	11630	6	130.00	23						
LT 195 1160	Diesel	11627	6	130.00	17						
LT 210	Diesel	11630	6	130.00	23						
NS 133 M	Diesel	6240	6	104.00	4						
NS 156	Diesel	6240	6	104.18	4						
NS 156 L	Diesel	6240	6	104.00	4						
NS 156 M	Diesel	6240	6	104.00	4						
NS 177 M	Diesel	6240	6	104.00	4						
NT 116	Diesel	6240	6	104.00	4						
NT 133	Diesel	6240	6	104.18	4						
PE 183 C	Diesel	9200	6	118.00	11						
PE 212 C	Diesel	9200	6	118.00	11						
PE 228 C	Diesel	9200	6	118.00	11						
PE 235 C	Diesel	9200	6	118.00	11						
PE 250 C	Diesel	9200	6	118.00	11						
PE 265 C	Diesel	9200	6	118.00	11						
PE 310 C	Diesel	9200	6	118.00	11						
PE 360 C	Diesel	9200	6	118.00	11						
PF 183 M	Diesel	9200	6	118.00	12						
PF 212 M	Diesel	9200	6	118.00	12						
PF 235 M	Diesel	9200	6	118.00	12						
RS 180	Diesel	8650	6	118.00	10						
RS 180 L	Diesel	8650	6	118.00	10						
RS 180 M	Diesel	8650	6	118.00	10						
RS 200	Diesel	8650	6	118.00	10						
RS 200 L	Diesel	8650	6	118.00	10						
RS 200 M	Diesel	8650	6	118.00	10						
RS 222	Diesel	8650	6	118.00	10						
RS 222 L	Diesel	8650	6	118.00	10						



21

9

65 CF FA 65 CF 180	02/98→12/00	4
65 CF FA 65 CF 210	02/98→12/00	4
65 CF FA 65 CF 240	02/98→12/00	4
65 CF FAV 65 CF 180	02/98→12/00	4
65 CF FAV 65 CF 210	02/98→12/00	4
65 FA 65.180	03/93→02/98	4
65 FA 65.210	03/93→02/98	4
65 FA 65.240	05/96→02/98	4
65 FAV 65.180	03/93→02/98	4
65 FAV 65.210	03/93→02/98	4
75 CF FA 75 CF 250	02/98→12/00	12
75 CF FA 75 CF 290	02/98→12/00	12
75 CF FA 75 CF 320	02/98→12/00	12
75 CF FAG 75 CF 250, FAN 75 CF 250	02/98→12/00	12
75 CF FAG 75 CF 290, FAN 75 CF 290	02/98→12/00	12
75 CF FAG 75 CF 320, FAN 75 CF 320	02/98→12/00	12
75 CF FAR 75 CF 250, FAS 75 CF 250	02/98→12/00	12
75 CF FAR 75 CF 290, FAS 75 CF 290	02/98→12/00	12
75 CF FAR 75 CF 320, FAS 75 CF 320	02/98→12/00	12
75 CF FAT 75 CF 250	02/98→12/00	12
75 CF FAT 75 CF 290	02/98→12/00	12
75 CF FAT 75 CF 320	02/98→12/00	12
75 CF FT 75 CF 250	02/98→12/00	12
75 CF FT 75 CF 290	02/98→12/00	12
75 CF FT 75 CF 320	02/98→12/00	12
75 FA 75.240	07/92→02/98	10
75 FA 75.270	07/92→02/98	10
75 FA 75.300	07/92→02/98	10
75 FAG 75.240, FAN 75.240	07/92→02/98	10
75 FAG 75.270, FAN 75.270	07/92→02/98	10
75 FAG 75.300, FAN 75.300	07/92→02/98	10
75 FAR 75.240, FAS 75.240	07/92→02/98	10
75 FAR 75.270, FAS 75.270	07/92→02/98	10
75 FAR 75.300, FAS 75.300	07/92→02/98	10
75 FAT 75.270	07/92→02/98	10
75 FAV 75.240	07/92→02/98	10
75 FAV 75.270	07/92→02/98	10
75 FT 75.240	07/92→02/98	10
75 FT 75.270	07/92→02/98	10
75 FT 75.300	07/92→02/98	10
85 CF FA 85 CF 340	02/98→12/00	26
85 CF FA 85 CF 380	02/98→12/00	26
85 CF FA 85 CF 430	02/98→12/00	26
85 CF FAC 85 CF 340	02/98→12/00	26
85 CF FAC 85 CF 380	02/98→12/00	26
85 CF FAC 85 CF 430	02/98→12/00	26
85 CF FAD 85 CF 340	02/98→12/00	26
85 CF FAD 85 CF 380	02/98→12/00	26
85 CF FAD 85 CF 430	02/98→12/00	26
85 CF FAG 85 CF 340, FAN 85 CF 340	02/98→12/00	26
85 CF FAG 85 CF 380, FAN 85 CF 380	02/98→12/00	26
85 CF FAG 85 CF 430, FAN 85 CF 430	02/98→12/00	26
85 CF FAR 85 CF 340	02/98→12/00	26
85 CF FAR 85 CF 380	02/98→12/00	26
85 CF FAR 85 CF 430	02/98→12/00	26
85 CF FAS 85 CF 340	02/98→12/00	26
85 CF FAS 85 CF 380	02/98→12/00	26
85 CF FAS 85 CF 430	02/98→12/00	26
85 CF FAT 85 CF 340	02/98→12/00	26
85 CF FAT 85 CF 380	02/98→12/00	26
85 CF FAT 85 CF 430	02/98→12/00	26
85 CF FT 85 CF 340	02/98→12/00	26
85 CF FT 85 CF 380	02/98→12/00	26
85 CF FT 85 CF 430	02/98→12/00	26
85 CF FTG 85 CF 340	02/98→12/00	26
85 CF FTG 85 CF 380	02/98→12/00	26
85 CF FTG 85 CF 430	02/98→12/00	26
85 CF FTT 85 CF 340	02/98→12/00	26
85 CF FTT 85 CF 430	02/98→12/00	26
85 FA 85.330	07/92→02/98	15
85 FA 85.360	07/92→02/98	15
85 FA 85.400	03/95→02/98	15
85 FAD 85.330	07/92→02/98	15



21

9

85 FAD 85.360	07/92→02/98	15
85 FAD 85.400	03/95→02/98	15
85 FAG 85.330, FAR 85.330, FAS 85.330	07/92→02/98	15
85 FAG 85.360, FAR 85.360, FAS 85.360	07/92→02/98	15
85 FAG 85.400, FAR 85.400, FAS 85.400	03/95→02/98	15
85 FAT 85.330	07/92→02/98	15
85 FAT 85.360	07/92→02/98	15
85 FAT 85.400	03/95→02/98	15
85 FT 85.330	07/92→02/98	15
85 FT 85.360	07/92→02/98	15
85 FT 85.400	03/95→02/98	15
85 FTG 85.330	07/92→02/98	15
85 FTG 85.360	07/92→02/98	15
85 FTG 85.400	03/95→02/98	15
85 FTT 85.330	07/92→02/98	15
85 FTT 85.360	07/92→02/98	15
85 FTT 85.400	03/95→02/98	15
95 FA 95.310	09/87→09/90	15
95 FA 95.330	08/90→01/93	15
95 FA 95.350	09/87→09/90	15
95 FA 95.360	08/90→01/98	15
95 FA 95.380	09/87→09/90	15
95 FA 95.400	08/90→01/98	15
95 FA 95.430	02/92→01/98	19
95 FAD 95.350	09/87→09/90	15
95 FAD 95.360	08/90→01/98	15
95 FAD 95.380	09/87→09/90	15
95 FAD 95.400	08/90→01/98	15
95 FAD 95.430	02/92→01/98	15
95 FAG 95.350, FAR 95.350, FAS 95.350	09/87→09/90	15
95 FAG 95.360, FAR 95.360, FAS 95.360	08/90→01/98	15
95 FAG 95.380, FAR 95.380, FAS 95.380	09/87→09/90	15
95 FAG 95.400, FAR 95.400, FAS 95.400	08/90→01/98	15
95 FAG 95.430, FAR 95.430, FAS 95.430	02/92→01/98	15
95 FAK 95.360	08/90→01/98	15
95 FAK 95.400	08/90→01/98	15
95 FAK 95.430	02/92→01/98	15
95 FAR 95.310	09/87→09/90	15
95 FAR 95.330, FAS 95.330	08/90→01/93	15
95 FAT 95.350	09/87→09/90	15
95 FAT 95.360	08/90→01/98	15
95 FAT 95.380	09/87→09/90	15
95 FAT 95.400	08/90→01/98	15
95 FAT 95.430	02/92→01/98	15
95 FT 95.310	09/87→09/90	15
95 FT 95.330	08/90→01/93	15
95 FT 95.350	09/87→09/90	15
95 FT 95.360	08/90→01/98	15
95 FT 95.380	09/87→09/90	15
95 FT 95.400	08/90→01/98	15
95 FT 95.430	02/92→01/98	15
95 FT 95.500	02/94→01/98	27
95 FTG 95.350, FTR 95.350	09/87→09/90	15
95 FTG 95.360, FTR 95.360, FTS 95.360	08/90→01/98	15
95 FTG 95.380, FTS 95.380	09/87→09/90	15
95 FTG 95.400, FTR 95.400, FTS 95.400	08/90→01/98	15
95 FTG 95.430, FTR 95.430, FTS 95.430	02/92→01/98	15
95 FTT 95.350	09/87→09/90	15
95 FTT 95.360	08/90→01/98	15
95 FTT 95.380	09/87→09/90	15
95 FTT 95.400	08/90→01/98	15
95 FTT 95.430	02/92→01/98	15
95 XF FA 95 XF 380	01/97→09/02	26
95 XF FA 95 XF 430	01/97→09/02	26
95 XF FA 95 XF 480	01/97→09/02	26
95 XF FAC 95 XF 380	01/97→09/02	26
95 XF FAC 95 XF 430	01/97→09/02	26
95 XF FAC 95 XF 480	01/97→09/02	26
95 XF FAD 95 XF 380	01/97→09/02	26
95 XF FAD 95 XF 430	01/97→09/02	26
95 XF FAD 95 XF 480	01/97→09/02	26
95 XF FAR 95 XF 380	01/97→09/02	26



21

9

95 XF FAR 95 XF 430	01/97→09/02	26
95 XF FAR 95 XF 480	01/97→09/02	26
95 XF FAS 95 XF 380	01/97→09/02	26
95 XF FAS 95 XF 430	01/97→09/02	26
95 XF FAS 95 XF 480	01/97→09/02	26
95 XF FAT 95 XF 380	01/97→09/02	26
95 XF FAT 95 XF 430	01/97→09/02	26
95 XF FAT 95 XF 480	01/97→09/02	26
95 XF FT 95 XF 380	01/97→09/02	26
95 XF FT 95 XF 430	01/97→09/02	26
95 XF FT 95 XF 480	01/97→09/02	26
95 XF FTG 95 XF 380	01/97→09/02	26
95 XF FTG 95 XF 430	01/97→09/02	26
95 XF FTG 95 XF 480	01/97→09/02	26
95 XF FTR 95 XF 380	01/97→09/02	26
95 XF FTR 95 XF 430	01/97→09/02	26
95 XF FTR 95 XF 480	01/97→09/02	26
95 XF FTS 95 XF 380	01/97→09/02	26
95 XF FTS 95 XF 430	01/97→09/02	26
95 XF FTS 95 XF 480	01/97→09/02	26
95 XF FTT 95 XF 380	01/97→09/02	26
95 XF FTT 95 XF 430	01/97→09/02	26
95 XF FTT 95 XF 480	01/97→09/02	26
CF 75 FA 75.250	01/01→	11
CF 75 FA 75.310	01/01→	11
CF 75 FA 75.360	01/01→	11
CF 75 FAG 75.250, FAN 75.250	01/01→	11
CF 75 FAG 75.310, FAN 75.310	01/01→	11
CF 75 FAG 75.360	01/01→	11
CF 75 FAR 75.250	01/01→	11
CF 75 FAR 75.310, FAS 75.310	01/01→	11
CF 75 FAR 75.360, FAS 75.360	01/01→	11
CF 75 FAT 75.250	01/01→	11
CF 75 FAT 75.310	01/01→	11
CF 75 FAT 75.360	01/01→	11
CF 75 FT 75.250	01/01→	11
CF 75 FT 75.310	01/01→	11
CF 75 FT 75.360	01/01→	11
CF 85 FTP 85.480		26
F 80-260 Series		18
F 900 FA 900 BDD	01/75→12/81	2
F 900 FA 900 BDF	11/81→11/88	3
F 900 FA 900 BDT	11/83→11/88	3
F 1100 FA 1100 DD	01/78→12/81	2
F 1100 FA 1100 DF	11/81→11/88	3
F 1100 FA 1100 DNTD	12/86→11/90	4
F 1100 FA 1100 DT	11/83→11/88	3
F 1200 FA 1200 DD	01/69→12/81	2
F 1300 FA 1300 DF	07/78→10/88	3
F 1300 FA 1300 DNT, FA 1300 NT	12/86→12/92	4
F 1300 FA 1300 DNTD, FA 1300 NB	12/86→12/92	4
F 1300 FA 1300 DT	07/78→02/90	3
F 1300 FA 1300 DT-B	07/78→02/90	3
F 1300 FA 1305 DT	07/78→02/90	3
F 1400 FA 1400 DD	02/72→12/81	2
F 1500 FA 1500 DF, FD 1500 DF	07/78→08/91	3
F 1500 FA 1500 DT, FD 1500 DT	07/78→08/91	3
F 1500 FT 1500 DT		3
F 1600 FA 1600 DF	01/70→08/91	3
F 1600 FA 1600 DT	01/73→08/91	3
F 1600 FGG 1600 DT, FGG 1621 DT	01/73→08/91	3
F 1600 FT 1600 DT	01/73→08/91	3
F 1700 FA 1700 DNS	01/88→02/95	4
F 1700 FA 1700 DNT, FA 1700 NT	12/86→02/95	4
F 1700 FA 1700 DNTD, FA 1700 NB, FD 1700 DNTD, FD 1700 NB	12/86→02/95	4
F 1700 FAG 1700 DNT, FAG 1700 NT	12/86→02/95	4
F 1700 FAG 1700 DNTD, FAG 1700 NB	12/86→02/95	4
F 1800 FAV 1800 DT	01/70→08/91	3
F 1900 FA 1900 DNS	12/86→09/93	4
F 1900 FA 1900 DNS, FA 1900 NS	12/86→09/93	4
F 1900 FA 1900 DNT, FA 1900 NT	12/86→09/93	4
F 1900 FA 1900 DNT, FD 1900 DNT, FD 1900 NT	12/86→09/93	4
F 1900 FAV 1900 DNT, FAV 1900 NT	12/86→09/93	4



21

9

F 1900 FT 1900 DNS, FT 1900 NS	12/86→09/93	4
F 2000 FA 2000 DH	01/70→12/79	5
F 2000 FA 2000 DHB	01/70→12/79	5
F 2000 FAS 2000 DH	01/70→12/79	5
F 2000 FAS 2000 DHB	01/70→12/79	5
F 2000 FAT 2000 DH	01/70→12/79	5
F 2000 FAT 2000 DHB	01/70→12/79	5
F 2000 FM 2000 DH	01/70→12/79	5
F 2000 FM 2000 DHB	01/70→12/79	5
F 2000 FT 2000 DH	01/70→12/79	5
F 2100 FA 2105 DHT	07/81→09/86	8
F 2100 FA 2100 DF, FA 2105 DF	07/78→09/86	3
F 2100 FA 2100 DH	07/78→09/86	5
F 2100 FA 2105 DH	06/86→08/91	5
F 2100 FA 2105 DHR, FA 2105 DHTD	07/78→09/86	5
F 2100 FA 2105 DHR, FA 2105 DHTD	07/78→09/86	6
F 2100 FA 2105 DHT	06/86→08/91	8
F 2100 FA 2105 DHTD	06/86→08/91	6
F 2100 FAG 2100 DH, FAG 2105 DH	07/78→09/86	5
F 2100 FAG 2100 DHR, FAG 2105 DHR, FAG 2100 DHTD	07/78→09/86	5
F 2100 FAG 2100 DHR, FAG 2105 DHR, FAG 2100 DHTD	07/78→09/86	6
F 2100 FAS 2100 DHR, FAS 2103 DHR, FAS 2105 DHR, FAS 2103 DHTD	07/78→09/86	5
F 2100 FAS 2100 DHR, FAS 2103 DHR, FAS 2105 DHR, FAS 2103 DHTD	07/78→09/86	6
F 2100 FAS 2103 DH	07/78→09/86	5
F 2100 FAS 2103 DH, FAS 2105 DH	06/86→08/91	5
F 2100 FAS 2103 DHT	07/81→09/86	8
F 2100 FAS 2103 DHTD	06/86→08/91	6
F 2100 FT 2100 DH, FT 2105 DH	07/78→08/91	5
F 2100 FT 2100 DHR	07/78→08/91	5
F 2100 FT 2105 DHT	07/81→09/86	8
F 2100 FT 2105 DHTD	07/81→08/91	6
F 2200 FA 2200 DU	01/71→11/80	7
F 2200 FAD 2205 DU	01/71→11/80	7
F 2200 FAS 2205 DU	01/71→11/80	7
F 2200 FAT 2205 DU	01/71→11/80	7
F 2200 FAZ 2205 DU	01/71→11/80	7
F 2200 FT 2200 DU	01/71→11/80	7
F 2300 FA 2300 DHR	07/78→12/81	5
F 2300 FA 2300 DHU	07/78→12/81	7
F 2300 FA 2300 HT	01/90→10/93	9
F 2300 FAB 2305 DHT, FAG 2305 DHT, FAS 2300 DHU, FAS 2303 DHU, FAS 2305	07/78→09/86	7
F 2300 FAB 2305 DHT, FAG 2305 DHT, FAS 2300 DHU, FAS 2303 DHU, FAS 2305	07/78→09/86	8
F 2300 FAG 2300 DHT, FAG 2305 DHT	11/81→08/91	8
F 2300 FAG 2300 DHTD, FAG 2305 DHTD	06/86→08/91	6
F 2300 FAG 2300 HT, FAR 2300 HT	01/90→10/93	9
F 2300 FAG 2305 DH	07/78→12/81	5
F 2300 FAG 2300 DHR, FAS 2305 DHR	07/78→12/81	5
F 2300 FAT 2300 HT	01/90→10/93	9
F 2300 FAT 2305 DH	07/78→12/81	5
F 2300 FAT 2305 DHR	07/78→12/81	5
F 2300 FAT 2305 DHU, FAT 2335 DHT	07/78→09/86	7
F 2300 FAT 2305 DHU, FAT 2335 DHT	07/78→09/86	8
F 2300 FAT 2335 DHT	06/86→08/91	8
F 2300 FAV 2300 HT	01/90→10/93	9
F 2300 FMB 2305 DHU	07/78→12/83	7
F 2300 FMT 2300 HT	01/90→10/93	9
F 2300 FMT 2305 DHR	07/78→12/81	5
F 2300 FMT 2305 DHU, FMT 2335 DHT	07/78→09/86	7
F 2300 FMT 2305 DHU, FMT 2335 DHT	07/78→09/86	8
F 2300 FMT 2335 DHT	06/86→08/91	8
F 2300 FT 2300 DHU, FT 2305 DHU	07/78→12/83	7
F 2300 FT 2300 HT	01/90→10/93	9
F 2500 FA 2500 DHS	02/82→08/86	6
F 2500 FA 2505 DHS	06/86→08/91	6
F 2500 FAD 2535 DHS	02/82→08/91	6
F 2500 FAG 2500 DHS, FAG 2505 DHS, FAS 2503 DHS	06/86→08/91	6
F 2500 FAG 2505 DHS, FAS 2503 DHS	02/82→09/86	6
F 2500 FAT 2525 DHS	02/82→08/91	6
F 2500 FAT 2525 DHS, FAT 2535 DHS	06/86→08/91	6
F 2500 FAT 2535 DHS	02/82→09/86	6
F 2500 FMD 2525 DHS	02/82→09/86	6



21

9

F 2500 FMD 2525 DHS, FMD 2535 DHS	06/86→08/91	6
F 2500 FMT 2525 DHS	02/82→09/86	6
F 2500 FMT 2525 DHS, FMT 2535 DHS	06/86→08/91	6
F 2500 FT 2500 DHS	02/82→09/86	6
F 2500 FT 2505 DHS	06/86→08/91	6
F 2600 FA 2600 DKB	02/72→12/73	13
F 2600 FAS 2600 DKB	02/72→12/73	13
F 2600 FAT 2600 DKB	02/72→12/73	13
F 2600 FT 2600 DKB	02/72→12/73	13
F 2600 FTT 2600 DKB	02/72→12/73	13
F 2700 FA 2700 HS	01/90→10/93	9
F 2700 FAB 2700 HS, FAG 2700 HS, FAR 2700 HS	01/90→10/93	9
F 2700 FAT 2700 HS	01/90→10/93	9
F 2700 FMT 2700 HS	01/90→10/93	9
F 2700 FT 2700 HS	01/90→10/93	9
F 2800 FA 2800 DKA	01/74→08/80	13
F 2800 FA 2800 DKS	01/74→09/86	14
F 2800 FA 2800 DKSE	01/80→09/86	14
F 2800 FA 2800 DKT	01/74→11/80	14
F 2800 FA 2800 DKTD	01/74→09/91	14
F 2800 FA 2805 DKSE, FA 2800 DKV, FA 2800 DKXE	05/83→09/91	14
F 2800 FAB 2805 DKS, FAR 2800 DKS, FAS 2800 DKS	01/74→09/86	14
F 2800 FAB 2805 DKTD, FAS 2800 DKTD	01/74→09/86	14
F 2800 FAC 2803 DKS	01/74→09/86	14
F 2800 FAC 2803 DKSE	01/80→07/90	14
F 2800 FAC 2803 DKTD	01/74→09/91	14
F 2800 FAD 2805 DKS	01/74→09/86	14
F 2800 FAD 2805 DKTD	01/74→06/86	14
F 2800 FAD 2825 DKTD	01/74→09/91	14
F 2800 FAG 2800 DKV, FAR 2804 DKXE, FAS 2803 DKXE, DKSE, DKV	05/83→09/91	14
F 2800 FAR 2804 DKSE, FAS 2800 DKT	01/80→09/86	14
F 2800 FAS 2800 DKA	01/74→11/80	13
F 2800 FAS 2803 DKS	06/86→09/91	14
F 2800 FAS 2803 DKTD	06/86→09/91	14
F 2800 FAT 2800 DKA	01/74→11/80	13
F 2800 FAT 2800 DKS	01/74→09/86	14
F 2800 FAT 2800 DKT	01/74→11/80	14
F 2800 FAT 2800 DKTD	01/74→09/86	14
F 2800 FAT 2805 DKS, FAT 2825 DKS	06/86→09/91	14
F 2800 FAT 2805 DKTD, FAT 2825 DKTD	06/86→09/91	14
F 2800 FMD 2805 DKTD, FMD 2825 DKTD	01/74→09/91	14
F 2800 FMD 2825 DKV	05/83→09/91	14
F 2800 FT 2800 DKA	01/74→11/80	13
F 2800 FT 2800 DKS	01/74→09/86	14
F 2800 FT 2800 DKSE, FT 2800DKXE, FT 2800 DKV	01/80→09/91	14
F 2800 FT 2800 DKT	01/74→11/80	14
F 2800 FT 2800 DKTD	01/74→09/86	14
F 2800 FT 2805 DKS	06/86→09/91	14
F 2800 FT 2805 DKTD	06/86→09/91	14
F 2800 FTS 2800 DKA	01/74→11/80	13
F 2800 FTS 2800 DKS	01/74→09/86	14
F 2800 FTS 2800 DKT	01/74→11/80	14
F 2800 FTS 2800 DKTD	01/74→09/86	14
F 2800 FTS 2803 DKS	06/86→09/91	14
F 2800 FTS 2803 DKTD	06/86→09/91	14
F 2800 FTT 2800 DKA	01/74→11/80	13
F 2800 FTT 2800 DKS	01/74→09/86	14
F 2800 FTT 2800 DKT	01/74→11/80	14
F 2800 FTT 2800 DKTD	01/74→09/86	14
F 2800 FTT 2805 DKS, FTT 2815 DKS, FTT 2825 DKS	06/86→09/91	14
F 2800 FTT 2805 DKTD	06/86→09/91	14
F 3300 FA 3300 DKX, FA 3305 DKX	06/81→09/86	14
F 3300 FA 3300 DKX, FA 3305 DKX	06/85→09/91	14
F 3300 FAB 3305 DKX, FAG 3300 DKX, FAR 3300 DKX, FAS 3303 DKX	06/81→09/86	14
F 3300 FAC 3303 DKX	06/81→09/86	14
F 3300 FAC 3303 DKX	06/85→09/91	14
F 3300 FAD 3325 DKX	06/81→09/86	14
F 3300 FAD 3325 DKX	06/85→09/91	14
F 3300 FAG 3300 DKX, FAR 3304 DKX, FAS 3303 DKX	06/85→09/91	14
F 3300 FAT 3325 DKX	06/81→09/86	14
F 3300 FAT 3325 DKX	06/85→09/91	14
F 3300 FT 3305 DKX	06/81→09/86	14
F 3300 FT 3305 DKX	06/85→09/91	14



21

9

F 3300 FTG 3300 DKX, FTS 3300 DKX	06/81→09/86	14
F 3300 FTG 3300 DKX, FTS 3303 DKX	06/85→09/91	14
F 3300 FTT 3325 DKX	06/81→09/86	14
F 3300 FTT 3325 DKX	06/85→09/91	14
F 3600 FA 3605 DKZ	06/85→09/91	14
F 3600 FA 3605 DKZE	06/85→09/91	14
F 3600 FAC 3603 DKZ	06/85→09/91	14
F 3600 FAG 3600 DKZ, FAR 3604 DKZ, FAS 3603 DKZ	06/85→09/91	14
F 3600 FAR 3604 DKZE, FAS 3603 DKZE	06/85→09/91	14
F 3600 FT 3605 DKZ	06/85→09/91	14
F 3600 FT 3605 DKZE	06/85→09/91	14
F 3600 FTG 3600 DKZ, FTS 3603 DKZ	06/85→09/91	14
F 3600 FTT 3625 DKZ	06/85→09/91	14
F80-300 Series		25
F85-300 Series (FAT)		25
F3300 Series	01/85→	16
F3305 Series	01/85→	16
F3325 Series	01/85→	16
F3603 Series	01/85→	16
F3625 Series	01/85→	16
F3650 Series	01/85→	16
N 2800 NAT 2826 DKS	01/81→09/91	14
N 3300 NAT 3326 DKX	01/81→09/91	14
SB SB 201	01/74→	20
SB SB 220 LT		23
SB3000 Series		17
XF 95 FAK 95.380		26
XF 95 FAK 95.430		26
XF 95 FAK 95.480		26
XF 95 FTP 95.380		26
XF 95 FTP 95.430		26
XF 95 FTP 95.480		26









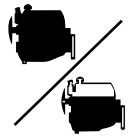



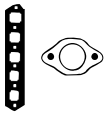



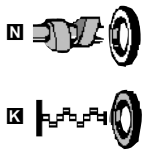
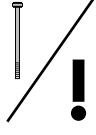



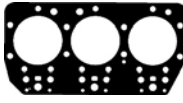

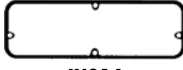

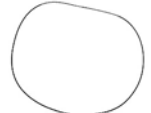
cc



kW/PS



1	DA 475	4770	6	100.62	Turbo Intercooled	66-100/ 90-136			EX030
2	DD 575	5750	6	100.00		77/105			EX030
3	DF 615	6150	6	104.18		85/115	AX050 (Fibre)	CX050 ■○	EX030
	DTD 615	6150	6	104.18	Turbo	101-123/ 137-167			
	DT 615	6150	6	104.18	Turbo	111/151			
4	NT 116	6240	6	104.00	Turbo	116/158	BW480 (Fibre)	DW480	EW480
	NS 133 M	6240	6	104.00	Euro 2/Turbo Intercooled	133/181			
	NS 156 L	6240	6	104.00	Euro 1/Turbo Intercooled	156/212			
	NS 156 M	6240	6	104.00	Euro 2/Turbo Intercooled	156/212			
	NS 177 M	6240	6	104.00	Euro 2/Turbo Intercooled	177/240			
	DNTD 620	6240	6	104.18	Turbo	116/158			
	DNT 620	6240	6	104.18	Turbo	132/180			
	NT 133	6240	6	104.18	Turbo	133/181			
	DNS 620/NS 156	6240	6	104.18	Turbo Intercooled	156/212			
5	DH 825	8250	6	118.00		115-121/ 156-165	BN660 (Fibre) (x2)	DN660 ○	EG700
	DHB 825	8250	6	118.00	Turbo	148/201			
	DHR 825	8250	6	118.00	Turbo	150/204			
6	DHTD 825	8250	6	118.00	Turbo	151/205	BN660 (Fibre) (x2)	DN663 ○	EG700
	DHS 825	8250	6	118.00	Turbo Intercooled	184-195/ 250-265			
	DHS 825SM	8250	6	118.00	Turbo Intercooled	217/294			
7	DU 825	8250	6	118.00	Turbo	159/216	BN660 (Fibre) (x2)		EG700
	DHU 825	8250	6	118.00	Turbo	169/230			
8	DHT 825	8250	6	118.00	Turbo	162-167/ 220-228	BN660 (Fibre) (x2)	DN663 ○	EG700
9	HT 825	8250	6	118.00	Turbo	168/228	AD5750 (Fibre), 1.3mm (x2)		EG700
	HS 825	8250	6	118.00	Turbo Intercooled	200/272			
10	RS 180	8650	6	118.00	Turbo Intercooled	180/245	AD5700 (Fibre), 1.25mm (x2)		
	RS 180 L	8650	6	118.00	Euro 1/Turbo Intercooled	180/245			
	RS 180 M	8650	6	118.00	Euro 2/Turbo Intercooled	180/245			
	RS 200	8650	6	118.00	Turbo Intercooled	200/272			
	RS 200 L	8650	6	118.00	Euro 1/Turbo Intercooled	200/272			
	RS 200 M	8650	6	118.00	Euro 2/Turbo Intercooled	200/272			
	RS 222	8650	6	118.00	Turbo Intercooled	222/302			
	RS 222 L	8650	6	118.00	Euro 1/Turbo Intercooled	222/302			
	RS 222 M	8650	6	118.00	Euro 2/Turbo Intercooled	222/302			
11	PE 183 C/PE 250 C	9200	6	118.00	Euro 3/Turbo Intercooled	183/249	AD5750 (Fibre), 1.3mm (x2)	CD5750 ■○	
	PE 212 C	9200	6	118.00	Euro 3/Turbo Intercooled	212/288			
	PE 228 C/PE 310 C	9200	6	118.00	Euro 3/Turbo Intercooled	228/310			
	PE 235 C	9200	6	118.00	Euro 3/Turbo Intercooled	235/320			
	PE 265 C/PE 360 C	9200	6	118.00	Euro 3/Turbo Intercooled	265/360			
12	PF 183 M	9200	6	118.00	Euro 2/Turbo Intercooled	183/249	AD5750 (Fibre), 1.3mm (x2)	CD5750 ■○	ED5750
	PF 212 M	9200	6	118.00	Euro 2/Turbo Intercooled	212/288			
	PF 235 M	9200	6	118.00	Euro 2/Turbo Intercooled	235/320			
13	DKA 1160	11600	6	130.00		169/230	BL710 (Steel) (x2)		EG692
	DKB 1160	11600	6	130.00	Turbo	226/308			

						 AD5700  AD5750  AX050  BL710  BN660  BW480  JN314  JN942  JN943  JJ523  JJ529
		JJ529				
		JJ528		<input checked="" type="checkbox"/> NB946  70x90x10mm, FPM		
		JJ528		<input checked="" type="checkbox"/> NB946  70x90x10mm, FPM		
		JJ528		<input checked="" type="checkbox"/> NB946  70x90x10mm, FPM		
	JN314	JJ528		<input checked="" type="checkbox"/> NB946  70x90x10mm, FPM		
		JJ528				
				<input checked="" type="checkbox"/> NB947  154x180x12mm, FPM		
	JN942 JN943 [1]	JJ523		<input checked="" type="checkbox"/> NB946  70x90x10mm, FPM <input checked="" type="checkbox"/> NB947  154x180x12mm, FPM		



cc



kW/PS

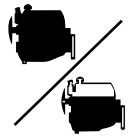

14	DKTL 1160	11600	6	130.00	Turbo	185/252	BL710 (Steel) (x2)	DL717 ○	EG692
	DKTD 1160	11600	6	130.00	Turbo	188-191/ 256-260			
	DKS 1160 E	11600	6	130.00	Turbo Intercooled	206/280			
	DKVL 1160	11600	6	130.00	Turbo	206/280			
	DKV 1160	11600	6	130.00	Turbo	212/288			
	DKXE 1160	11600	6	130.00	Turbo Intercooled	212/288			
	DKT 1160	11600	6	130.00	Turbo	213/290			
	DKZE 1160	11600	6	130.00	Turbo Intercooled	226/307			
	DKS 1160	11600	6	130.00	Turbo	228/310			
	DKX 1160	11600	6	130.00	Turbo Intercooled	243/330			
	DKX 1160 ATi	11600	6	130.00	Turbo Intercooled	260/354			
DKZ 1160 ATi	11600	6	130.00	Turbo Intercooled	274/373				
15	WS 225	11600	6	130.00	Turbo Intercooled	225/306	BW470 (Fibre) (x2)	DW470 ■○	EW470
	WS 242	11600	6	130.00	Turbo Intercooled	242/330			
	WS 242 L	11600	6	130.00	Euro 1/Turbo Intercooled	242/330			
	WS 242 M	11600	6	130.00	Euro 2/Turbo Intercooled	242/330			
	WS 259	11600	6	130.00	Turbo Intercooled	259/352			
	WS 268 G	11600	6	130.00	Turbo Intercooled	268/364			
	WS 268	11600	6	130.00	Turbo Intercooled	268/365			
	WS 268 L	11600	6	130.00	Euro 1/Turbo Intercooled	268/365			
	WS 268 M	11600	6	130.00	Euro 2/Turbo Intercooled	268/365			
	WS 282	11600	6	130.00	Turbo Intercooled	282/384			
	WS 295/WS 295 G	11600	6	130.00	Turbo Intercooled	295/401			
	WS 295 L	11600	6	130.00	Euro 1/Turbo Intercooled	295/401			
	WS 295 M	11600	6	130.00	Euro 2/Turbo Intercooled	295/401			
	WS 315	11600	6	130.00	Turbo Intercooled	315/428			
	WS 315 L	11600	6	130.00	Euro 1/Turbo Intercooled	315/428			
WS 315 M	11600	6	130.00	Euro 2/Turbo Intercooled	315/428				
16	DKZ 1160 ATi	11627	6	130.00			BL710 (Steel) (x2)	DL717 ○	EG692
17	LT 195 1160	11627	6	130.00		195/265	BL710 (Steel) (x2)	DL717 ○	
18	KT 191	11627	6	130.00	Turbo Intercooled	256/348	BW470 (Fibre) (x2)	DW470 ■○	
19	WS 295 M Ati	11627	6	130.00	Turbo Intercooled	295/401	BW470 (Fibre) (x2)	DW470 ■○	EW470
	WS 315 G	11627	6	130.00	Turbo	315/428			
20	DKDL 1160	11630	6	130.00	Turbo Intercooled	121/164	BL710 (Steel) (x2)	DL714 ○	
	DKD 1160	11630	6	130.00	Turbo	121/165			
	DKL 1160	11630	6	130.00	Turbo Intercooled	148-151/ 201-205			
21	DKXE 1160 ATi	11630	6	130.00	Turbo Intercooled	139-274/ 189-373	BL710 (Steel) (x2)	DL717 ○	EG692
	DKCL 1160	11630	6	130.00	Turbo Intercooled	156/212			
	DKFL 1160	11630	6	130.00	Turbo Intercooled	191/260			
	DKSE 1160	11630	6	130.00	Turbo Intercooled	206/280			
	DKSB 1160	11630	6	130.00	Turbo Intercooled	228/310			
22	DK 1160	11630	6	130.00	Turbo Intercooled	156/212	BL710 (Steel) (x2) Eng.F24001 →		EG692
23	LT 160	11630	6	130.00	Straight	160 - 170/ 218-231	BL710 (Steel) (x2)	DL717 ○	
	LT 210	11630	6	130.00	Turbo Intercooled	206-210/ 280-286			
24	WS 222 G/WS 222 M	11630	6	130.00	Turbo Intercooled	222/302	BW470 (Fibre) (x2)		EW470
	WS 270	11630	6	130.00	Turbo Intercooled	270/367			

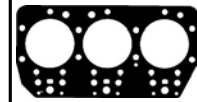
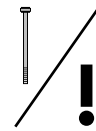
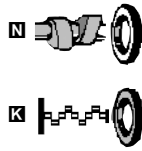
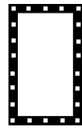
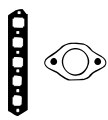

BL710

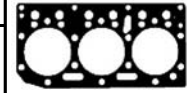

BW470



JN942

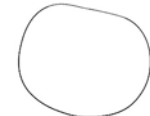

JN943



JJ523

	JN942 JN943 [1]	JJ523		<input checked="" type="checkbox"/> NB946 70x90x10mm, FPM <input checked="" type="checkbox"/> NB947 154x180x12mm, FPM	
JD5271 (x6)	JN943 [1]	JJ524		<input checked="" type="checkbox"/> NB956 100x124x12mm, FPM <input checked="" type="checkbox"/> NB947 154x180x12mm, FPM	
	JN942 JN943 [1]	JJ523		<input checked="" type="checkbox"/> NB946 70x90x10mm, FPM <input checked="" type="checkbox"/> NB947 154x180x12mm, FPM	
	JN942 JN943 [1]	JJ523		<input checked="" type="checkbox"/> NB946 70x90x10mm, FPM <input checked="" type="checkbox"/> NB947 154x180x12mm, FPM	
	JN943 [1]	JJ524			
JD5271 (x6)	JN943 [1]	JJ524		<input checked="" type="checkbox"/> NB956 100x124x12mm, FPM <input checked="" type="checkbox"/> NB947 154x180x12mm, FPM	
	JN942 JN943 [1]	JJ523		<input checked="" type="checkbox"/> NB946 70x90x10mm, FPM <input checked="" type="checkbox"/> NB947 154x180x12mm, FPM	
	JN942 JN943 [1]	JJ523		<input checked="" type="checkbox"/> NB946 70x90x10mm, FPM <input checked="" type="checkbox"/> NB947 154x180x12mm, FPM	
	JN942 JN943 [1]	JJ523		<input checked="" type="checkbox"/> NB946 70x90x10mm, FPM <input checked="" type="checkbox"/> NB947 154x180x12mm, FPM	
	JN942 JN943 [1]	JJ523		<input checked="" type="checkbox"/> NB946 70x90x10mm, FPM <input checked="" type="checkbox"/> NB947 154x180x12mm, FPM	
JD5271 (x6)	JN943 [1]	JJ524		<input checked="" type="checkbox"/> NB956 100x124x12mm, FPM <input checked="" type="checkbox"/> NB947 154x180x12mm, FPM	

DAF



cc



Ø





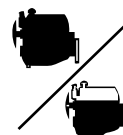





kW/PS



25	WS 222 L	11630	6	130.00	Turbo Intercooled	222/302	BW470 (Fibre) (x2)	DW470 ■○	EW470
	WS 225 ATi	11630	6	130.00	Turbo Intercooled	225/306			
	WS 259 ATi	11630	6	130.00	Turbo Intercooled	259/352			
	WS 282 ATi/WS 282 L	11630	6	130.00	Turbo Intercooled	282/383			
26	XF 250 M	12580	6	130.00	Euro 2/Turbo Intercooled	250/340	BW470 (Fibre) (x2)	DW472 ○ [2] DW473 ○ [3]	EW474
	XF 280 M	12580	6	130.00	Euro 2/Turbo Intercooled	280/381			
	XF 315 M	12580	6	130.00	Euro 2/Turbo Intercooled	315/428			
	XF 355 M	12580	6	130.00	Euro 2/Turbo Intercooled	355/483			
27	VF 373 M	14000	6	140.00	Euro 2/Turbo Intercooled	373/507	AH5370 (MLS)		

						<p>BW470</p> <p>JN943</p>
JD5271 (x6)	JN943 [1]	JJ524		<input checked="" type="checkbox"/> NB956 100x124x12mm, FPM <input checked="" type="checkbox"/> NB947 154x180x12mm, FPM		
				<input checked="" type="checkbox"/> NB956 100x124x12mm, FPM <input checked="" type="checkbox"/> NB947 154x180x12mm, FPM		

		CC			9			CC			9
8220.02.842	Diesel	9572	6	125.00	23						
8360.05.670	Diesel	8100	6	115.00	17						
BF 4L 913	Diesel	4068	4	102.00	4						
BF 4L 913	Diesel	4086	4	102.00	5						
BF 4L 913 T	Diesel	4086	4	102.00	5						
BF 4L 914	Diesel	4314	4	102.00	6						
BF 4M 2012	Diesel	4038	4	101.00	3						
BF 4M 2012 C	Diesel	4038	4	101.00	3						
BF 6L 413	Diesel	8478	6	120.00	18						
BF 6L 413 FR	Diesel	9572	6	125.00	21						
BF 6L 513	Diesel	9572	6	125.00	21						
BF 6L 513 C	Diesel	9572	6	125.00	22						
BF 6L 912	Diesel	5655	6	100.00	11						
BF 6L 913	Diesel	6128	6	102.00	15						
BF 6L 913 C	Diesel	6128	6	102.00	14						
BF 6L 913 T	Diesel	6128	6	102.00	14						
BF 6L 914	Diesel	6472	6	102.00	16						
BF 6L 914 C	Diesel	6472	6	102.00	16						
BF 6M 2013	Diesel	5702	6	98.00	13						
BF 6M 2013 C	Diesel	5702	6	98.00	13						
BF 8L 413	Diesel	11310	8	120.00	24						
BF 8L 413 F	Diesel	12763	8	125.00	28						
BF 8L 513	Diesel	12763	8	125.00	28						
BF 8L 513 LC	Diesel	13745	8	125.00	30						
BF 8L 513-225	Diesel	12763	8	128.00	28						
BF 8L 513-243	Diesel	12763	8	128.00	28						
BF10L 413 F	Diesel	15953	10	125.00	33						
BF10L 513	Diesel	15954	10	125.00	34						
BF10L 513 F	Diesel	15945	10	125.00	32						
BF12 L 413 F	Diesel	19144	12	125.00	39						
BF12L 413	Diesel	16964	12	120.00	37						
BF12L 413 F	Diesel	19144	12	125.00	39						
BF12L 513	Diesel	19144	12	125.00	39						
BF12L 513 C	Diesel	19144	12	125.00	39						
BF12L 513 F	Diesel	19144	12	125.00	39						
F 3L 1011 F	Diesel	2049	3	91.00	1						
F 4L 912	Diesel	3770	4	100.00	2						
F 4L 912 D	Diesel	3770	4	100.00	2						
F 4L 912 W	Diesel	3770	4	100.00	2						
F 4L 913	Diesel	4086	4	102.00	5						
F 4L 913 D	Diesel	4086	4	102.00	5						
F 4L 914	Diesel	4314	4	102.00	6						
F 5L 912	Diesel	4712	5	100.00	7						
F 5L 912 D	Diesel	4712	5	100.00	7						
F 5L 914	Diesel	5393	5	102.00	10						
F 6L 413 F	Diesel	9570	6	125.00	19						
F 6L 413 F	Diesel	9572	6	125.00	21						
F 6L 413 FW	Diesel	9572	6	125.00	20						
F 6L 712	Diesel	5100	6	95.00	8						
F 6L 712	Diesel	5104	6	95.00	9						
F 6L 812	Diesel	5100	6	95.00	8						
F 6L 812 D	Diesel	5100	6	95.00	8						
F 6L 912	Diesel	5660	6	100.00	12						
F 6L 912 D	Diesel	5655	6	100.00	11						
F 6L 912 W	Diesel	5655	6	100.00	11						
F 6L 913	Diesel	6128	6	102.00	14						
F 6L 913 D	Diesel	6128	6	102.00	14						
F 6L 914	Diesel	6472	6	102.00	16						
F 8L 413	Diesel	11310	8	120.00	25						
F 8L 413 F	Diesel	12763	8	125.00	28						
F 8L 413 FW	Diesel	12763	8	125.00	27						
F 8L 513	Diesel	13383	8	128.00	29						
F 8L 914	Diesel	12667	8	120.00	26						
F10L 413	Diesel	14140	10	120.00	31						
F10L 413 F	Diesel	15953	10	125.00	33						
F10L 413 FW	Diesel	15953	10	125.00	33						
F10L 513	Diesel	16728	10	128.00	35						
F10L 513 F	Diesel	15953	10	125.00	33						
F12L 413	Diesel	16960	12	120.00	36						
F12L 413 F	Diesel	19144	12	125.00	39						
F12L 413 F	Diesel	19144	12	125.00	40						
F12L 413 FW	Diesel	19144	12	125.00	38						
F12L 513	Diesel	20074	12	128.00	41						



cc



Ø



kW/PS

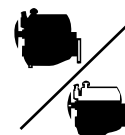

1	F 3L 1011 F	2049	3	91.00		16-33/ 22-45	AH5570 (Fibre), 1.48mm, 1 Notch AH5580 (Fibre), 1.55mm, 2 Notches AH5590 (Fibre), 1.60mm, 3 Notches		
2	F 4L 912	3770	4	100.00		32-54/ 44-73	BM780 (Steel) (x4)	HL210 ▲ (x4)	
	F 4L 912 D/F 4L 912 W	3770	4	100.00		38/52			
	F 4L 912	3770	4	100.00		55/75			
	F 4L 912	3770	4	100.00		59/80			
3	BF 4M 2012	4038	4	101.00	Turbo	74-75/ 101-102	AG9370 (MLS), 1,24mm AG9380 (MLS), 1,34mm AG9390 (MLS), 1,44mm		
	BF 4M 2012 C	4038	4	101.00	Turbo Intercooled	84-93/ 114-126			
	BF 4M 2012 C	4038	4	101.00	Turbo Intercooled	93-103/ 126-140			
4	BF 4L 913	4068	4	102.00	Turbo	47-78/ 64-106	BM780 (Steel) (x4)	HL210 ▲ (x4)	
5	F 4L 913 D	4086	4	102.00		34-59/ 46-80	BM780 (Steel) (x4)	HL210 ▲ (x4)	
	F 4L 913	4086	4	102.00		50-78/ 68-106			
	BF 4L 913 T	4086	4	102.00	Turbo	64-78/ 87-106			
	F 4L 913	4086	4	102.00		64/87			
	BF 4L 913	4086	4	102.00	Turbo	78-81/ 106-110			
6	F 4L 914	4314	4	102.00		61/82	BM780 (Steel) (x4)		
	BF 4L 914	4314	4	102.00	Turbo	75/102			
7	F 5L 912	4712	5	100.00		40-68/ 54-92	BM780 (Steel) (x5)	HL210 ▲ (x5)	GM790 ▲
	F 5L 912 D	4712	5	100.00		58/79			
8	F 6L 812	5100	6	95.00		55-74/ 75-101			
	F 6L 712	5100	6	95.00		66/89			
	F 6L 812 D	5100	6	95.00		74/100			
9	F 6L 712	5104	6	95.00		66/90			
10	F 5L 914	5393	5	102.00		75/102	BM780 (Steel) (x5)		
11	F 6L 912 D	5655	6	100.00		42/57	BM780 (Steel) (x6)	HL210 ▲ (x6)	
	F 6L 912 W	5655	6	100.00		57/78			
	BF 6L 912	5655	6	100.00	Turbo	88-100/ 120-136			
12	F 6L 912	5660	6	100.00		48-82/ 65-112	BM780 (Steel) (x6)	HL210 ▲ (x6)	GM785 ▲○
	F 6L 912	5660	6	100.00		88/120			
13	BF 6M 2013	5702	6	98.00	Euro 3/Turbo	92/125	AG9400 (MLS), 1.16mm AG9410 (MLS), 1.26mm AG9420 (MLS), 1.36mm		
	BF 6M 2013 C	5702	6	98.00	Euro 3/Turbo Intercooled	118-190/ 160-258			
14	F 6L 913 D	6128	6	102.00		51-89/ 69-121	BM780 (Steel) (x6)	HL210 ▲ (x6)	
	BF 6L 913 C	6128	6	102.00	Turbo Intercooled	81-142/ 110-193			
	BF 6L 913 T	6128	6	102.00	Turbo	85-112/ 115-152			
	F 6L 913	6128	6	102.00		96/131			

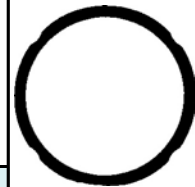
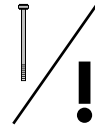
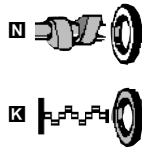
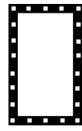
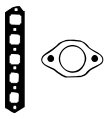

BM780

			PB180 8x12/15.4x9.5 866N W (FPM)		
JB188 (x4)	JM869 (x4)			<input checked="" type="checkbox"/> NB938 65x85x13mm, FPM <input checked="" type="checkbox"/> NB939 115x140x16mm, FPM	
			HR801		
JB188 (x4)	JM869 (x4)			<input checked="" type="checkbox"/> NB938 65x85x13mm, FPM <input checked="" type="checkbox"/> NB939 115x140x16mm, FPM	
JB188 (x4)	JM869 (x4)			<input checked="" type="checkbox"/> NB938 65x85x13mm, FPM <input checked="" type="checkbox"/> NB939 115x140x16mm, FPM	
JB188 (x4)	JM869 (x4)				
JB188 (x5)	JM869 (x5)			<input checked="" type="checkbox"/> NB938 65x85x13mm, FPM <input checked="" type="checkbox"/> NB939 115x140x16mm, FPM	
JB188 (x6)	JM869 (x6)			<input checked="" type="checkbox"/> NB938 65x85x13mm, FPM <input checked="" type="checkbox"/> NB939 115x140x16mm, FPM	
JB188 (x6)	JM869 (x6)			<input checked="" type="checkbox"/> NB938 65x85x13mm, FPM <input checked="" type="checkbox"/> NB939 115x140x16mm, FPM	
JB188 (x5)					
JB188 (x6)	JM869 (x6)			<input checked="" type="checkbox"/> NB938 65x85x13mm, FPM <input checked="" type="checkbox"/> NB939 115x140x16mm, FPM	
JB188 (x6)	JM869 (x6)			<input checked="" type="checkbox"/> NB938 65x85x13mm, FPM <input checked="" type="checkbox"/> NB939 115x140x16mm, FPM	
			HR801		
JB188 (x6)	JM869 (x6)			<input checked="" type="checkbox"/> NB938 65x85x13mm, FPM <input checked="" type="checkbox"/> NB939 115x140x16mm, FPM	



cc



Ø



kW/PS

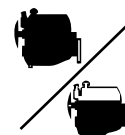

15	BF 6L 913	6128	6	102.00	Turbo	70-118/ 95-160	BM780 (Steel) (x6)	HL210 ▲ (x6)	GM789
	BF 6L 913	6128	6	102.00	Turbo	118-124/ 160-169			
	BF 6L 913	6128	6	102.00	Turbo	118/160			
16	BF 6L 914	6472	6	102.00	Turbo	80-116/ 109-158	BM780 (Steel) (x6)		
	F 6L 914	6472	6	102.00		92/125			
	BF 6L 914 C	6472	6	102.00	Turbo Intercooled	107-147/ 145-200			
17	8360.05.670	8100	6	115.00		119/162	AY020 (Fibre)	DD843 ○	GD843 ○
18	BF 6L 413	8478	6	120.00	Turbo/V	99/135		HL363 ▲ (x6) [4] HL399 ▲ (x6) [5]	
19	F 6L 413 F	9570	6	125.00		141/192		HL363 ▲ (x6) [4] HL399 ▲ (x6) [5]	
20	F 6L 413 FW	9572	6	125.00	V	96-121/ 131-165			
21	F 6L 413 F	9572	6	125.00	V	104-188/ 141-256		HL363 ▲ (x6) [4] HL399 ▲ (x6) [5]	
	F 6L 413 F	9572	6	125.00	V	125/170			
	BF 6L 513	9572	6	125.00	Turbo/V	141-210/ 192-286			
	BF 6L 413 FR	9572	6	125.00	Turbo	143/194			
22	BF 6L 513 C	9572	6	125.00	Turbo Intercooled/V	112-177/ 152-241		HL363 ▲ (x6) [4] HL399 ▲ (x6) [5]	
23	8220.02.842	9572	6	125.00		154/210	BR390 (Fibre) (x2)	DR393 ○	GR393 ○
24	BF 8L 413	11310	8	120.00	Turbo/V	99/135		HL363 ▲ (x8) [4] HL399 ▲ (x8) [5]	
25	F 8L 413	11310	8	120.00	V	169-171/ 230-233			FL203
26	F 8L 914	12667	8	120.00	V	169/230	BM780 (Steel) (x8)		
27	F 8L 413 FW	12763	8	125.00	V	129-150/ 175-204			
28	F 8L 413 F	12763	8	125.00	V	147-188/ 200-256		HL363 ▲ (x8) [4] HL399 ▲ (x8) [5]	
	F 8L 413 F	12763	8	125.00	V	188/256			
	BF 8L 413 F	12763	8	125.00	Turbo/V	212-235/ 288-320			
	BF 8L 513	12763	8	125.00	Turbo/V	235-250/ 320-340			
	BF 8L 513-225	12763	8	128.00	Turbo/V	225/306			
BF 8L 513-243	12763	8	128.00	Turbo/V	243/330				
29	F 8L 513	13383	8	128.00	V	155-194/ 211-264		HL363 ▲ (x8) [4] HL399 ▲ (x8) [5]	
	F 8L 513	13383	8	128.00	V	168-174/ 228-237			
30	BF 8L 513 LC	13745	8	125.00	Turbo Intercooled/V	265-274/ 360-373		HL363 ▲ (x8) [4] HL399 ▲ (x8) [5]	
31	F10L 413	14140	10	120.00	V	199-224/ 270-305			
32	BF10L 513 F	15945	10	125.00	Turbo/V	253-294/ 344-400		HL363 ▲ (x10) [4] HL399 ▲ (x10) [5]	
33	F10L 413 FW	15953	10	125.00	V	161-202/ 219-275		HL363 ▲ (x10) [4] HL399 ▲ (x10) [5]	
	F10L 413 F/F10L 513 F	15953	10	125.00	V	235/320			
	BF10L 413 F	15953	10	125.00	Turbo/V	265/360			
	BF10L 413 F	15953	10	125.00	Turbo/V	265-294/ 360-400			

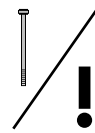
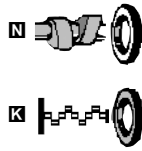
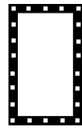
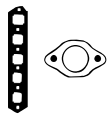

AY020

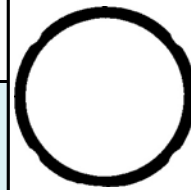

BM780

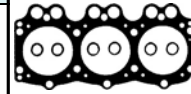



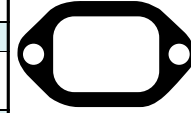







































BR390



JC268



JN222

JB188  (x6)	JM869 (x6)			<input checked="" type="checkbox"/> NB938  65x85x13mm, FPM <input checked="" type="checkbox"/> NB939  115x140x16mm, FPM	
JB188  (x6)	JM869 (x6)		HR801 		
	JN222 (x2)				
JD172  (x6)					
JD172  (x6)				<input checked="" type="checkbox"/> NB934  100x120x15mm, FPM <input checked="" type="checkbox"/> NB935  105x130x15mm, FPM	
JD172  (x6)				<input checked="" type="checkbox"/> NB934  100x120x15mm, FPM <input checked="" type="checkbox"/> NB935  105x130x15mm, FPM	
JD172  (x6)				<input checked="" type="checkbox"/> NB934  100x120x15mm, FPM <input checked="" type="checkbox"/> NB935  105x130x15mm, FPM	
JD172  (x6)					
JC268  (x6)					
JD172  (x8)				<input checked="" type="checkbox"/> NB934  100x120x15mm, FPM <input checked="" type="checkbox"/> NB935  105x130x15mm, FPM	
JB188  (x8)			HR801 		
JD172  (x8)				<input checked="" type="checkbox"/> NB934  100x120x15mm, FPM <input checked="" type="checkbox"/> NB935  105x130x15mm, FPM	
JD172  (x8)				<input checked="" type="checkbox"/> NB934  100x120x15mm, FPM <input checked="" type="checkbox"/> NB935  105x130x15mm, FPM	
JD172  (x8)				<input checked="" type="checkbox"/> NB934  100x120x15mm, FPM <input checked="" type="checkbox"/> NB935  105x130x15mm, FPM	
JD172  (x8)				<input checked="" type="checkbox"/> NB934  100x120x15mm, FPM <input checked="" type="checkbox"/> NB935  105x130x15mm, FPM	
				<input checked="" type="checkbox"/> NB934  100x120x15mm, FPM <input checked="" type="checkbox"/> NB935  105x130x15mm, FPM	
JD172  (x10)				<input checked="" type="checkbox"/> NB934  100x120x15mm, FPM <input checked="" type="checkbox"/> NB935  105x130x15mm, FPM	
JD172  (x10)				<input checked="" type="checkbox"/> NB934  100x120x15mm, FPM <input checked="" type="checkbox"/> NB935  105x130x15mm, FPM	

DEUTZ / KHD



cc





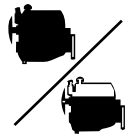



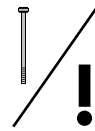
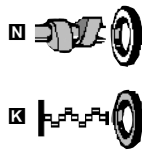
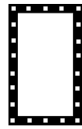
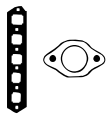

























kW/PS











34	BF10L 513	15954	10	125.00	Turbo/V	218-305/ 296-415		HL363 ▲ (x10)[4] HL399 ▲ (x10)[5]	
35	F10L 513	16728	10	128.00	V	188-242/ 256-329		HL363 ▲ (x10)[4] HL399 ▲ (x10)[5]	GM791
36	F12L 413	16960	12	120.00	V	250/340			
37	BF12L 413	16964	12	120.00	Turbo/V	305/415			
38	F12L 413 FW	19144	12	125.00	V	193-243/ 262-330			
39	F12L 413 F	19144	12	125.00	V	224-282/ 305-384		HL363 ▲ (x12)[4] HL399 ▲ (x12)[5]	
	BF12 L 413 F/BF12L 413 F	19144	12	125.00	Turbo/V	268-353/ 364-480			
	BF12L 513 F	19144	12	125.00	Turbo/V	282-353/ 384-480			
	BF12L 513	19144	12	125.00	Turbo/V	353-367/ 480-499			
	BF12L 513 C	19144	12	125.00	Turbo Intercooled/V	386-405/ 525-551			
40	F12L 413 F	19144	12	125.00	V	224-282/ 305-384		HL363 ▲ (x12)[4] HL399 ▲ (x12)[5]	
41	F12L 513	20074	12	128.00	V	282/384		HL363 ▲ (x12)[4] HL399 ▲ (x12)[5]	



JD172  (x10)				<input checked="" type="checkbox"/> NB934  F 100x120x15mm, FPM <input checked="" type="checkbox"/> NB935  R 105x130x15mm, FPM	
JD172  (x10)				<input checked="" type="checkbox"/> NB934  F 100x120x15mm, FPM <input checked="" type="checkbox"/> NB935  R 105x130x15mm, FPM	
JD172  (x12)				<input checked="" type="checkbox"/> NB934  F 100x120x15mm, FPM <input checked="" type="checkbox"/> NB935  R 105x130x15mm, FPM	
JD172  (x12)				<input checked="" type="checkbox"/> NB934  F 100x120x15mm, FPM <input checked="" type="checkbox"/> NB935  R 105x130x15mm, FPM	
JD172  (x12)				<input checked="" type="checkbox"/> NB934  F 100x120x15mm, FPM <input checked="" type="checkbox"/> NB935  R 105x130x15mm, FPM	
JD172  (x12)				<input checked="" type="checkbox"/> NB934  F 100x120x15mm, FPM <input checked="" type="checkbox"/> NB935  R 105x130x15mm, FPM	
JD172  (x12)				<input checked="" type="checkbox"/> NB934  F 100x120x15mm, FPM <input checked="" type="checkbox"/> NB935  R 105x130x15mm, FPM	
JD172  (x12)				<input checked="" type="checkbox"/> NB934  F 100x120x15mm, FPM <input checked="" type="checkbox"/> NB935  R 105x130x15mm, FPM	

		cc			9			cc			9
203 A/61.000	Diesel	11548	6	130.00	37	8060.25.621	Diesel	5861	6	104.00	19
203 H/61..	Diesel	11548	6	130.00	38	8060.25.630	Diesel	5861	6	104.00	19
8040.02	Diesel	3456	4	100.00	3	8060.25.631	Diesel	5861	6	104.00	19
8040.02.041	Diesel	3456	4	100.00	2	8060.25.641	Diesel	5861	6	104.00	19
8040.02.267	Diesel	3456	4	100.00	2	8060.25.661	Diesel	5861	6	104.00	19
8040.02.300	Diesel	3455	4	100.00	1	8060.25.662	Diesel	5861	6	104.00	19
8040.02.360	Diesel	3456	4	100.00	2	8060.25.663	Diesel	5861	6	104.00	19
8040.02.367	Diesel	3456	4	100.00	2	8060.25.669	Diesel	5861	6	104.00	19
8040.04.200	Diesel	3666	4	103.00	4	8060.25.670	Diesel	5861	6	104.00	19
8040.04.280	Diesel	3666	4	103.00	4	8060.25.673	Diesel	5861	6	104.00	19
8040.05.200	Diesel	3908	4	104.00	5	8060.25.678	Diesel	5861	6	104.00	19
8040.05.230	Diesel	3908	4	104.00	5	8060.25.679	Diesel	5861	6	104.00	22
8040.05.4990	Diesel	3908	4	104.00	6	8060.25R.4200	Diesel	5861	6	104.00	21
8040.25.200	Diesel	3908	4	104.00	7	8060.25R.4280	Diesel	5861	6	104.00	21
8040.25.220	Diesel	3908	4	104.00	7	8060.25V.4000	Diesel	5861	6	104.00	21
8040.25B.4200 (LTC)	Diesel	3908	4	104.00	6	8060.25V.4080	Diesel	5861	6	104.00	21
8040.25X.4000	Diesel	3908	4	104.00	6	8060.45.4100	Diesel	5861	6	104.00	21
8040.45.261	Diesel	3908	4	104.00	6	8060.45.4180	Diesel	5861	6	104.00	21
8040.45.271	Diesel	3908	4	104.00	6	8060.45.600	Diesel	5861	6	104.00	21
8040.45.4000 (TCA)	Diesel	3908	4	104.00	6	8060.45.6090	Diesel	5861	6	104.00	21
8040.45.4180 (TCA)	Diesel	3908	4	104.00	6	8060.45S.6000	Diesel	5861	6	104.00	21
8040.45.5200	Diesel	3908	4	104.00	6	8060.45S.6700	Diesel	5861	6	104.00	21
8060.02.000	Diesel	5184	6	100.00	11	8060.45S.6800	Diesel	5861	6	104.00	21
8060.02.001	Diesel	5184	6	100.00	11	8200.02.220	Diesel	9820	6	122.00	36
8060.02.003	Diesel	5184	6	100.00	11	8200.12.000	Diesel	9820	6	122.00	35
8060.02.070	Diesel	5184	6	100.00	11	8210.02.000	Diesel	13798	6	137.00	40
8060.04.000	Diesel	5499	6	103.00	15	8210.02.020	Diesel	13798	6	137.00	40
8060.04.051	Diesel	5499	6	103.00	13	8210.02.022	Diesel	13798	6	137.00	40
8060.04.052	Diesel	5499	6	103.00	13	8210.02.032	Diesel	13798	6	137.00	40
8060.04.055	Diesel	5499	6	103.00	13	8210.02.033	Diesel	13798	6	137.00	40
8060.04.060	Diesel	5499	6	103.00	13	8210.02.053	Diesel	13798	6	137.00	40
8060.04.070	Diesel	5499	6	103.00	13	8210.02.067	Diesel	13798	6	137.00	40
8060.04.620	Diesel	5499	6	103.00	13	8210.02.069	Diesel	13798	6	137.00	40
8060.04.621	Diesel	5499	6	103.00	13	8210.02.081	Diesel	13798	6	137.00	40
8060.04.630	Diesel	5499	6	103.00	13	8210.02.266	Diesel	13798	6	137.00	40
8060.04.639	Diesel	5499	6	103.00	13	8210.02.267	Diesel	13798	6	137.00	40
8060.04.658	Diesel	5499	6	103.00	13	8210.02.290	Diesel	13798	6	137.00	40
8060.04.660	Diesel	5499	6	103.00	13	8210.02.371	Diesel	13798	6	137.00	40
8060.04.661	Diesel	5499	6	103.00	13	8210.02.373	Diesel	13798	6	137.00	40
8060.04.662	Diesel	5499	6	103.00	13	8210.02.377	Diesel	13798	6	137.00	40
8060.04.669	Diesel	5499	6	103.00	13	8210.02.385	Diesel	13798	6	137.00	40
8060.04.670	Diesel	5499	6	103.00	13	8210.02.393	Diesel	13798	6	137.00	40
8060.04.672	Diesel	5499	6	103.00	13	8210.02.405	Diesel	13798	6	137.00	40
8060.04.675	Diesel	5499	6	103.00	13	8210.02.426	Diesel	13798	6	137.00	40
8060.04.689	Diesel	5499	6	103.00	13	8210.02.440	Diesel	13798	6	137.00	40
8060.05.000	Diesel	5861	6	104.00	18	8210.02.441	Diesel	13798	6	137.00	40
8060.05.200	Diesel	5861	6	104.00	18	8210.02.731	Diesel	13798	6	137.00	40
8060.05.246	Diesel	5861	6	104.00	18	8210.02.791	Diesel	13798	6	137.00	40
8060.05.270	Diesel	5861	6	104.00	18	8210.02.793	Diesel	13798	6	137.00	40
8060.05.280	Diesel	5861	6	104.00	18	8210.22.000	Diesel	13798	6	137.00	43
8060.05.285	Diesel	5861	6	104.00	18	8210.22.069	Diesel	13798	6	137.00	42
8060.05.289	Diesel	5861	6	104.00	18	8210.22.101	Diesel	13798	6	137.00	42
8060.05.661	Diesel	5861	6	104.00	18	8210.22.105	Diesel	13798	6	137.00	42
8060.05.662	Diesel	5861	6	104.00	18	8210.22.171	Diesel	13798	6	137.00	42
8060.05.663	Diesel	5861	6	104.00	18	8210.22.175	Diesel	13798	6	137.00	42
8060.05.673	Diesel	5861	6	104.00	18	8210.22.183	Diesel	13798	6	137.00	42
8060.12	Diesel	5180	6	100.00	10	8210.22.235	Diesel	13798	6	137.00	42
8060.12.031	Diesel	5180	6	100.00	10	8210.22.269	Diesel	13798	6	137.00	42
8060.24.601	Diesel	5499	6	103.00	14	8210.22.290	Diesel	13798	6	137.00	42
8060.24.643	Diesel	5499	6	103.00	14	8210.22.317	Diesel	13798	6	137.00	42
8060.24.661	Diesel	5500	6	103.00	17	8210.22.327	Diesel	13798	6	137.00	42
8060.24.662	Diesel	5499	6	103.00	14	8210.22.373	Diesel	13798	6	137.00	42
8060.24.664	Diesel	5499	6	103.00	14	8210.22.385	Diesel	13798	6	137.00	42
8060.24.670	Diesel	5499	6	103.00	14	8210.22.406	Diesel	13798	6	137.00	42
8060.24.671	Diesel	5499	6	103.00	14	8210.22.569	Diesel	13798	6	137.00	42
8060.24.673	Diesel	5499	6	103.00	14	8210.22.869	Diesel	13798	6	137.00	42
8060.24.678	Diesel	5500	6	103.00	17	8210.22X.069	Diesel	13798	6	137.00	42
8060.25.221	Diesel	5861	6	104.00	20	8210.22X.235	Diesel	13798	6	137.00	42
8060.25.241	Diesel	5861	6	104.00	20	8210.22X.523	Diesel	13798	6	137.00	42
8060.25.243	Diesel	5861	6	104.00	20	8210.22X.575	Diesel	13798	6	137.00	42
8060.25.246	Diesel	5861	6	104.00	20	8210.42 K	Diesel	13798	6	137.00	46
8060.25.4600	Diesel	5499	6	103.00	16	8210.42(TCA)	Diesel	13798	6	137.00	41
8060.25.600	Diesel	5861	6	104.00	19	8210.42.009	Diesel	13798	6	137.00	44

		CC			9			CC			9
8210.42.061	Diesel	13798	6	137.00	45	8280.42.001	Diesel	17174	8	145.00	52
8210.42.073	Diesel	13798	6	137.00	45	8280.42.050	Diesel	17174	8	145.00	52
8210.42.101	Diesel	13798	6	137.00	45	8280.42S (TCA)	Diesel	17173	8	145.00	47
8210.42.115	Diesel	13798	6	137.00	45	8280.42S.350	Diesel	17174	8	145.00	52
8210.42.151	Diesel	13798	6	137.00	45	8340.05	Diesel	5400	4	115.00	12
8210.42.152	Diesel	13798	6	137.00	45	8360.05	Diesel	8100	6	115.00	25
8210.42.154	Diesel	13798	6	137.00	45	8360.05.B	Diesel	8100	6	115.00	26
8210.42.155	Diesel	13798	6	137.00	45	C 03	Diesel	4940	4	110.00	8
8210.42.161	Diesel	13798	6	137.00	45	C 03-36	Diesel	4940	4	110.00	9
8210.42.162	Diesel	13798	6	137.00	45	CP 3	Diesel	7412	6	110.00	23
8210.42.165	Diesel	13798	6	137.00	45	CP 3/32.1.200	Diesel	7412	6	110.00	24
8210.42.171	Diesel	13798	6	137.00	45						
8210.42.172	Diesel	13798	6	137.00	45						
8210.42.173	Diesel	13798	6	137.00	45						
8210.42.174	Diesel	13798	6	137.00	45						
8210.42.175	Diesel	13798	6	137.00	45						
8210.42.176	Diesel	13798	6	137.00	45						
8210.42.177	Diesel	13798	6	137.00	45						
8210.42.181	Diesel	13798	6	137.00	45						
8210.42.182	Diesel	13798	6	137.00	45						
8210.42.185	Diesel	13798	6	137.00	45						
8210.42.186	Diesel	13798	6	137.00	45						
8210.42.191	Diesel	13798	6	137.00	45						
8210.42.192	Diesel	13798	6	137.00	45						
8210.42.195	Diesel	13798	6	137.00	45						
8210.42.196	Diesel	13798	6	137.00	45						
8210.42.290	Diesel	13798	6	137.00	45						
8210.42K.(TCA)	Diesel	13798	6	137.00	46						
8210.42L.(TCA)	Diesel	13798	6	137.00	46						
8210.42L.400	Diesel	13798	6	137.00	46						
8210.42L.TCA	Diesel	13798	6	137.00	46						
8210.42M.(TCA)	Diesel	13798	6	137.00	41						
8210.42R.269	Diesel	13798	6	137.00	41						
8211.02.032	Diesel	13798	6	137.00	41						
8220.02.701	Diesel	9572	6	125.00	31						
8220.02.834	Diesel	9572	6	125.00	31						
8220.02.842	Diesel	9570	6	125.00	27						
8220.02.847	Diesel	9572	6	125.00	31						
8220.02.856	Diesel	9572	6	125.00	31						
8220.02.870	Diesel	9572	6	125.00	31						
8220.12.001	Diesel	9570	6	125.00	28						
8220.12.709	Diesel	9572	6	125.00	32						
8220.22.002	Diesel	9572	6	125.00	33						
8220.22.102	Diesel	9572	6	125.00	33						
8220.22.104	Diesel	9572	6	125.00	33						
8220.22.106	Diesel	9572	6	125.00	33						
8220.22.708	Diesel	9570	6	125.00	29						
8220.22.709	Diesel	9570	6	125.00	29						
8220.32.701	Diesel	9572	6	125.00	34						
8220.32.721	Diesel	9570	6	125.00	30						
8220.32.723	Diesel	9570	6	125.00	30						
8260.02.405	Diesel	12880	6	145.00	39						
8280.01.000	Diesel	17174	8	145.00	48						
8280.02.000	Diesel	17174	8	145.00	49						
8280.02.024	Diesel	17174	8	145.00	49						
8280.02.082	Diesel	17174	8	145.00	49						
8280.02.109	Diesel	17174	8	145.00	49						
8280.02.120	Diesel	17174	8	145.00	50						
8280.02.125-135	Diesel	17174	8	145.00	49						
8280.02.128	Diesel	17174	8	145.00	50						
8280.02.269	Diesel	17174	8	145.00	49						
8280.02.274	Diesel	17174	8	145.00	49						
8280.02.275	Diesel	17174	8	145.00	49						
8280.02.289	Diesel	17174	8	145.00	49						
8280.02.405	Diesel	17174	8	145.00	49						
8280.22.007	Diesel	17174	8	145.00	51						
8280.22.009	Diesel	17174	8	145.00	51						
8280.22.033	Diesel	17174	8	145.00	51						
8280.22.048	Diesel	17174	8	145.00	51						
8280.22.054	Diesel	17174	8	145.00	51						
8280.22.154	Diesel	17174	8	145.00	51						
8280.22.201	Diesel	17174	8	145.00	51						
8280.22.205	Diesel	17174	8	145.00	51						



21

9



21

9

Series 50 50N, 50NC	01/72->12/76	3
Series 55 55N	01/72->12/76	3
Series 65 65P	01/75->12/79	3
Series 75 75P	01/75->12/79	11
Series 80 80N	01/72->12/76	11
Series 80 80N, 80NC	01/72->12/76	11
Series 90 90N, 90NC	01/72->12/76	11
Series 90 90P	01/75->12/79	11
Series 100 100E	01/73->12/76	11
Series 100 100NC	01/73->12/75	11
Series 110 110NC	01/73->12/83	11
Series 300 306, 306/3	->12/71	38
Series 300 308	->12/71	35
Series 300 308L	->12/71	35
Series 300 314/3		10
Series 300 343, 343GT	->12/71	35
Series 300 370S25L		40
Series 300 370S30		43
Series 300 370S35		49
Series 400 418, 418A, 418AL	->12/71	35
Series 600 645N3	01/70->12/72	11
Series 600 684N	01/70->12/80	36
Series 600 684NP	01/74->12/80	36
Series 600 684T, 684TL, 684TP	01/70->12/80	36

FIAT COMMERCIAL



cc



kW/PS

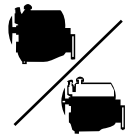

1	8040.02.300	3455	4	100.00		56/76	AN460 (Fibre), 1.35mm	CN468 ▲■○	FN46A ▲○
2	8040.02.041/8040.02.267/ 8040.02.360/8040.02.367	3456	4	100.00		56/76	AN460 (Fibre), 1.35mm	CN468 ▲■○	FN46A ▲○
3	8040.02	3456	4	100.00		60/81	AN460 (Fibre), 1.35mm AY650 (Fibre), 1.58mm	CN468 ▲■○	FN46A ▲○
4	8040.04.200 8040.04.280	3666 3666	4 4	103.00 103.00		63/85 63/86	BV520 (Fibre), 1.35mm BS340 (Fibre), 1.58mm	DH147 ▲○ [7]	GH147 ▲○
5	8040.05.200/8040.05.230	3908	4	104.00		65/88	BV520 (Fibre), 1.35mm BS340 (Fibre), 1.58mm	DH146 ▲○ [7]	GH146 ▲○
6	8040.25B.4200 (LTC) 8040.45.261/8040.45.271 8040.05.4990 8040.25X.4000 8040.45.4000 (TCA)/ 8040.45.4180 (TCA) 8040.45.5200	3908 3908 3908 3908 3908 3908	4 4 4 4 4 4	104.00 104.00 104.00 104.00 104.00	Turbo Turbo Turbo Turbo Turbo Intercooled	75/102 77/105 80/109 85/116 100/136	BV520 (Fibre), 1.35mm BS340 (Fibre), 1.58mm	DV520 ▲○ [7]	GV520 ▲○
7	8040.25.200/8040.25.220	3908	4	104.00	Turbo	85/115	BV520 (Fibre), 1.35mm BS340 (Fibre), 1.58mm	DH145 ▲	GH145 ▲○
8	C 03	4940	4	110.00		67/91	AN010 (Fibre)	CN01B ▲■○ CN01E ■○	FN01B ▲○ [7] FN01E ○ [7]
9	C 03-36	4940	4	110.00		76/103	AN010 (Fibre)	CN01B ▲■○ CN01E ■○	FN01E ○ [7]
10	8060.12.031 8060.12	5180 5180	6 6	100.00 100.00		81/110 88/120	AN470 (Fibre)	CN470 ▲○ [7]	FN470 ▲○ [7]
11	8060.02.000/8060.02.001/ 8060.02.003/8060.02.070	5184	6	100.00		90/122	AN470 (Fibre)	CN470 ▲○ [7]	FN470 ▲○ [7]
12	8340.05	5400	4	115.00		63/86	BD830 (Fibre)	DD832 ■○	GD832 ○
13	8060.04.661 8060.04.052 8060.04.051 8060.04.055/8060.04.060 8060.04.660 8060.04.662 8060.04.070/8060.04.620/ 8060.04.621 8060.04.630 8060.04.639/8060.04.658 8060.04.669 8060.04.670/8060.04.672/ 8060.04.675 8060.04.689	5499 5499 5499 5499 5499 5499 5499 5499 5499 5499 5499	6 6 6 6 6 6 6 6 6 6 6	103.00 103.00 103.00 103.00 103.00 103.00 103.00 103.00 103.00		81/110 92/125 95-96/ 130-131 96/131 96-102/ 131-139 96/131 99/135 99-100/ 135-136 99/135 99-102/ 135-139 99/135 99-102/ 135-139	BV710 (Fibre), 1.35mm BW160 (Fibre), 1.58mm	DH158 ▲○	GH15A ▲○

				NA5039 95x120x13mm, FPM NA5039 95x120x13mm, FPM		JM661 AN010 JM666 AN460, AY650 JN192 AN470 JN312 BD830 JN935 HC127 BV520, BS340 HC331 BV710, BW160 HC413 JA866 HC466 JC234 HC480 JC732 JD225 JD229 JE476 JE479	
JC732 ■ JD229 ■ (x4) JE476	JN192 (ACM)	HC466 ■		NA5039 95x120x13mm, FPM NA5041 ■ 42x65x12mm, ACM NA5040 ■ 110x135x13mm, FPM	KA499 [10] LR948 [10] LS051 [49] HJ069 [13] ■		
JC732 ■ JD229 ■ (x4) JE476	JN192 (ACM)	HC466 ■			KA499 [10] LS051 [49] HJ069 [13] ■		
JC732 ■ JD229 ■ (x4)	JN935 (Viton)	HC480 ■		NA5041 ■ 42x65x12mm, ACM NA5040 ■ 110x135x13mm, FPM	KA499 [10] LR948 [10]		
JC732 ■ JD229 ■ (x4)	JN935 (Viton)	HC480 ■		NA5040 ■ 110x135x13mm, FPM	LR948 [10] HJ070 [13] ■		
JC732 ■ JD229 ■ (x4)	JN935 (Viton)	HC466 ■ HC480 ■					
JA866 ■ JE479	JM666	HC331 ■	PA159	NA5038 ■ 85x105x12mm, FPM NA5043 ■ 75x100x17mm, FPM	KK195 [14] ■ KK196 [14] ■ KL351 [14] ■		
JC732 ■ JD229 ■ (x6)	JM661 (NBR)	HC127 ■		NA5039 95x120x13mm, FPM	KA499 [10] LR948 [10] HJ070 [13] ■		
JC732 ■ JD225 ■ (x6)	JM661 (NBR)	HC127 ■		NA5039 95x120x13mm, FPM	KA499 [10] LR948 [10] LS048 [50] LS051 [49] HJ070 [13] ■		
JC234 ■ JD229 ■	JN312 JM661 (NBR)	HC413 ■ HC127 ■	KG936	NA5040 ■ 110x135x13mm, FPM	HJ237 [13] ■ KA499 [10] LS048 [50] LS051 [49] HJ070 [13] ■		

FIAT COMMERCIAL



cc



kW/PS

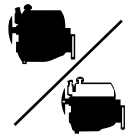

14	8060.24.662/8060.24.664/ 8060.24.673	5499	6	103.00	Turbo	96/131	BV710 (Fibre), 1.35mm BW160 (Fibre), 1.58mm	DH159 ▲ [7]	GH15B ▲○
	8060.24.643	5499	6	103.00	Turbo	103/140			
	8060.24.670/8060.24.671	5499	6	103.00	Turbo	118/160			
	8060.24.601	5499	6	103.00	Turbo	124/168			
15	8060.04.000	5499	6	103.00		99/135	BV710 (Fibre), 1.35mm BW160 (Fibre), 1.58mm	DH158 ▲○	GH15A ▲○
16	8060.25.4600	5499	6	103.00	Turbo	130/177	BV710 (Fibre), 1.35mm	DV711 ▲	GV711 ▲○
17	8060.24.661	5500	6	103.00	Turbo	90/122	BV710 (Fibre), 1.35mm	DH159 ▲ [7]	GH15B ▲○
	8060.24.678	5500	6	103.00	Turbo	123/167	BW160 (Fibre), 1.58mm		
18	8060.05.000	5861	6	104.00		79-102/ 108-139	BV710 (Fibre), 1.35mm BW160 (Fibre), 1.58mm	DH157 ▲○	GH159 ○
	8060.05.661/8060.05.663	5861	6	104.00		81/110			
	8060.05.662/8060.05.673	5861	6	104.00		96/131			
	8060.05.200	5861	6	104.00		99-102/ 135-139			
	8060.05.246/8060.05.285	5861	6	104.00		101/137			
	8060.05.270	5861	6	104.00		101-102/ 138-139			
	8060.05.280/8060.05.289	5861	6	104.00		102/139			
19	8060.25.663	5861	6	104.00	Turbo	88-96/ 118-131	BV710 (Fibre), 1.35mm BW160 (Fibre), 1.58mm	DH157 ▲○ DV711 ▲	GV711 ▲○
	8060.25.661	5861	6	104.00		88-96/ 120-131			
	8060.25.662/8060.25.673	5861	6	104.00	Turbo	96/131			
	8060.25.630/8060.25.631	5861	6	104.00	Turbo	100/136			
	8060.25.641	5861	6	104.00	Turbo	103/140			
	8060.25.621	5861	6	104.00	Turbo	110/150			
	8060.25.669/8060.25.670	5861	6	104.00	Turbo	125/170			
	8060.25.600/8060.25.678	5861	6	104.00	Turbo	130/177			
20	8060.25.241/8060.25.243/ 8060.25.246	5861	6	104.00	Turbo	100/136	BV520 (Fibre), 1.35mm BV710 (Fibre), 1.35mm BS340 (Fibre), 1.58mm	DH157 ▲○ DV711 ▲	GV711 ▲○
	8060.25.221	5861	6	104.00	Turbo	116/158			
	8060.25R.4200/ 8060.25R.4280	5861	6	104.00	Turbo Intercooled	105/143	BV710 (Fibre), 1.35mm BW160 (Fibre), 1.58mm	DV710 ▲○	GV710 ▲○
	8060.25V.4000/ 8060.25V.4080	5861	6	104.00	Turbo Intercooled	130/177			
	8060.45.4100/ 8060.45.4180/8060.45.600	5861	6	104.00	Turbo Intercooled	152/207			
	8060.45.6090/ 8060.45S.6000/ 8060.45S.6700/ 8060.45S.6800	5861	6	104.00	Turbo Intercooled	167/227			
22	8060.25.679	5861	6	104.00	Turbo	130/177	BV710 (Fibre), 1.35mm BW160 (Fibre), 1.58mm	DH157 ▲○ DV711 ▲	GV711 ▲○
23	CP 3	7412	6	110.00		107/145	AN340 (Fibre)	CN340 ▲○ [7] CN344 ○ [7] CN347 ■	FN344 ▲○ [7] FN349 ○
	CP 3/32.1.200	7412	6	110.00		107-110/ 145-150	AN340 (Fibre)	CN344 ○ [7] CN347 ■○	FN344 ▲○ [7] FN349 ○
	8360.05	8100	6	115.00		95-124/ 129-169	AY020 (Fibre)	DD843 ○	GD843 ○

JC732 ■ JD229 ■ (x6)	JM661 (NBR)	HC127 ■	KG936	NA5040 ■ 110x135x13mm, FPM	KA499 [10] LS048 [50] LS051 [49] HJ070 [13] ■	AY020 BV520, BS340	HC479
JC732 ■ JD229 ■ (x6)	JM661 (NBR)	HC127 ■	KG936	NA5040 ■ 110x135x13mm, FPM	KA499 [10] LS048 [50] LS051 [49] HJ070 [13] ■	BV710, BW160	
JD229 ■ (x6)							
JC732 ■ JD229 ■ (x6)	JM661 (NBR)	HC127 ■	KG936	NA5040 ■ 110x135x13mm, FPM	KA499 [10] LS048 [50] LS051 [49] HJ070 [13] ■	JA866	
JC732 ■ JD229 ■ (x6)	JN748 (Viton)	HC479 ■			KA499 [10]	JC234	
JC732 ■ JD229 ■ (x6)	JN748 (Viton)	HC479 ■			HJ070 [13] ■	JC732	
JC732 ■ JD229 ■ (x6)	JN748 (Viton)	HC479 ■			HJ070 [13] ■	JD229	
JD229 ■ (x6)						JE479	
JC732 ■ JD229 ■ (x6)	JN748 (Viton)	HC479 ■			HJ070 [13] ■ JE150 [51][52]	JM661	
JC732 ■ JD229 ■ (x6)	JN748 (Viton)	HC479 ■				JM667	
JC732 ■ JD229 ■ (x6)	JN748 (Viton)	HC479 ■				JN222	
JC732 ■ JD229 ■ (x6)	JN748 (Viton)	HC479 ■				JN748	
JA866 ■ JE479	JM667 JN222 (x2)	HC428 ■			KK195 [14] ■ KK196 [14] ■ HJ057 [13] ■	HC127	
	JN222 (x2)						
JC234 ■ (x3)	JN222 (x2)	HC416 ■			HJ070 [13] ■	HC416	

FIAT COMMERCIAL









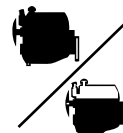



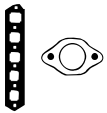

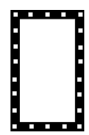

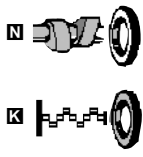
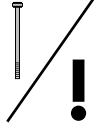

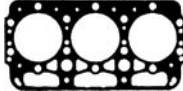

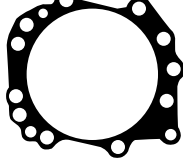

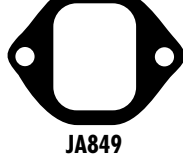













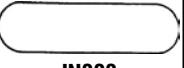
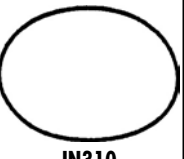
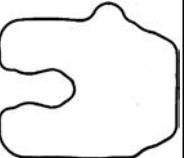
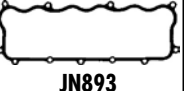

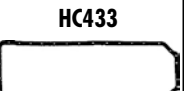
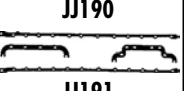

























































cc



kW/PS



26	8360.05.B	8100	6	115.00		101-110/ 137-150	AY020 (Fibre)	DR843 ○	GD843 ○
27	8220.02.842	9570	6	125.00	Turbo	148/201	BR390 (Fibre) (x2)	DR393 ○	GR393 ○
28	8220.12.001	9570	6	125.00		148/201	AY370 (Fibre)	DR402 ■○	GH671 GR402 ○
29	8220.22.708/8220.22.709	9570	6	125.00	Turbo	177/240	BR390 (Fibre)	DR392 ■○	GR392 ○
30	8220.32.721/8220.32.723	9570	6	125.00	Turbo	177/240	AY370 (Fibre)	DR401 ○	
31	8220.02.701/8220.02.834/ 8220.02.870 8220.02.847/8220.02.856	9572 9572	6 6	125.00 125.00		148/201 151/205	BR390 (Fibre) (x2)	DR393 ○	GR393 ○
32	8220.12.709	9572	6	125.00		149/203	AY370 (Fibre)	DR402 ■○	GH671 GR402 ○
33	8220.22.002/8220.22.102/ 8220.22.104/8220.22.106	9572	6	125.00	Turbo	177/240	BR390 (Fibre)	DR392 ■○	GR392 ○
34	8220.32.701	9572	6	125.00	Turbo	177/240	AY370 (Fibre)	DR401 ○	
35	8200.12.000	9820	6	122.00		140/190		DC200 ▲	
36	8200.02.220	9820	6	122.00		147/200	AN360 (Fibre) (x2) AX700 (Fibre)	DC551 ▲○	GC551 ▲○
37	203 A/61.000	11548	6	130.00		132/180	AL350 (Fibre) AL360 (Fibre) [15]	CL356 ▲■○	FL35D ▲○ [7]
38	203 H/61..	11548	6	130.00		132/180	AL350 (Fibre) AL360 (Fibre) [15]	CL356 ▲■○	
39	8260.02.405	12880	6	145.00		191/260	BK490 BH790 (SE), 1.20mm	DH797 ▲○ [7]	GH794 ▲○

     						
	JN222 (x2)					 AN360  AX700  AY020  AY370  BH790  BR390  JA849  JA893  JA894  JC267  JC268  JC458
JC268  (x6)		JJ191 JJ190 			HT026 [14]  HT027 [14]  HT028 [14]  HT029 [14]  HT030 [14] 	 JE639  JN222  JN310  JN311  JN893  HC104  HC433  JJ190  JJ191
JC458  JC268  (x6)	JN893 (x2)	HC433 			HT026 [14]  HT027 [14]  HT028 [14]  HT029 [14]  HT030 [14] 	
JC267  JC268  (x6)	JN893 (x2)	JJ191			HT026 [14]  HT027 [14]  HT028 [14]  HT029 [14]  HT030 [14] 	
JC267  JC268  (x6)	JN893 (x2)	HC433 			HT026 [14]  HT027 [14]  HT028 [14]  HT029 [14]  HT030 [14] 	
JC268  (x6)		JJ191 JJ190 			HT026 [14]  HT027 [14]  HT028 [14]  HT029 [14]  HT030 [14] 	
JC458  JC268  (x6)	JN893 (x2)	HC433 			HT026 [14]  HT027 [14]  HT028 [14]  HT029 [14]  HT030 [14] 	
JC267  JC268  (x6)	JN893 (x2)	JJ191			HT026 [14]  HT027 [14]  HT028 [14]  HT029 [14]  HT030 [14] 	
JC267  JC268  (x6)	JN893 (x2)	HC433 			HT026 [14]  HT027 [14]  HT028 [14]  HT029 [14]  HT030 [14] 	
 JE639 (x2)					HJ240 [13]  KV482 [55]	
JA893  JA894   JE639 (x2)					HJ240 [13]  KV477 [55] LA602 [55]	
JA849 		HC104 				
JA849 		HC104 				
	JN310  (x12) JN311  (x6)				HL5080 [14] 	

FIAT COMMERCIAL







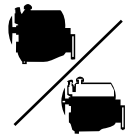

cc

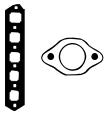

kW/PS

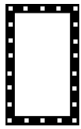

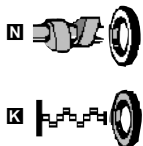
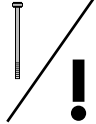
40	8210.02.000/8210.02.020/ 8210.02.022/8210.02.032/ 8210.02.033/8210.02.053/ 8210.02.067/8210.02.069/ 8210.02.081/8210.02.266/ 8210.02.267/8210.02.290/ 8210.02.371/8210.02.373/ 8210.02.377/8210.02.385/ 8210.02.393/8210.02.405/ 8210.02.426/8210.02.440/ 8210.02.441/8210.02.731/ 8210.02.791/8210.02.793	13798	6	137.00		191/260	BL991 (SE)	DL994 ▲○	GL994 ▲○
41	8211.02.032 8210.42R.269 8210.42(TCA) 8210.42M.(TCA)	13798 13798 13798 13798	6 6 6 6	137.00 137.00 137.00 137.00	Turbo Intercooled Turbo Euro 2/Turbo Intercooled	191/260 265/360 272/370 345/470	BW151	DW151 ▲○	GW151 ▲○
42	8210.22.069 8210.22.171 8210.22.175 8210.22.183/8210.22.235/ 8210.22.269/8210.22.290/ 8210.22.317/8210.22.327/ 8210.22.385/8210.22.406/ 8210.22.569/8210.22X.069/ 8210.22X.235/ 8210.22X.523/ 8210.22X.575 8210.22.101/8210.22.373 8210.22.869 8210.22.105	13798 13798 13798 13798 13798 13798 13798	6 6 6 6 6 6 6	137.00 137.00 137.00 137.00 137.00 137.00 137.00	Turbo Turbo Turbo Turbo Turbo Turbo Turbo Intercooled	221-224/ 300-305 224/304 224/304 224/304 224/305 235/320 243/330	BL991 (SE) (x2)	DL992 ▲■○	GL992 ▲○
43	8210.22.000	13798	6	137.00	Turbo	224/305	BL991 (SE) (x2)	DL992 ▲■○	GL992 ▲○
44	8210.42.009	13798	6	137.00	Turbo Intercooled	265/360	BW151 (x2)	DW151 ▲○	GW151 ▲○
45	8210.42.101/8210.42.115/ 8210.42.290 8210.42.061/8210.42.073/ 8210.42.151/8210.42.152/ 8210.42.154/8210.42.155/ 8210.42.161/8210.42.162 8210.42.165 8210.42.171/8210.42.172/ 8210.42.173/8210.42.174/ 8210.42.175/8210.42.176/ 8210.42.177/8210.42.181/ 8210.42.182/8210.42.185/ 8210.42.186/8210.42.191/ 8210.42.192/8210.42.195/ 8210.42.196	13798 13798 13798 13798	6 6 6 6	137.00 137.00 137.00 137.00	Turbo Intercooled Turbo Intercooled Turbo Turbo Intercooled	265/360 277/377 277/377 277/377	BL991 (SE) (x2) BW151 (x2)	DL993 ▲○	GL993 ▲○

						
JC874 ■ (x2) JC873 ■ (x2)	JN796 (x2)	JJ518 (Cork)			LT987 [56] KV477 [55] LA602 [55] LS109 [55]	
KD5001 ■ ■ ■	JN796 (x2)	JJ518 (Cork)			KV477 [55]	
JC874 ■ (x2) JC873 ■ (x2)	JN796 (x2)	JJ518 (Cork)			KV477 [55] LA602 [55]	
JC873 ■ (x2)	JN796 (x2)	JJ518 (Cork)			KV477 [55] LA602 [55]	
KD5001 ■ ■ ■	JN796 (x2)	JJ518 (Cork)			KV477 [55]	
JC874 ■ (x2) JC873 ■ (x2)	JN796 (x2)	JJ518 (Cork)			KV477 [55] LA602 [55]	

FIAT COMMERCIAL



cc





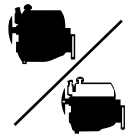





kW/PS



46	8210.42 K/8210.42K.(TCA) 8210.42L.(TCA) 8210.42L.400 8210.42L.TCA	13798 13798 13798 13798	6 6 6 6	137.00 137.00 137.00 137.00	Euro 1/Turbo Intercooled Turbo Intercooled Turbo Intercooled Turbo Intercooled	272/370 309/420 309/420 345/470	BW151 →03/96 BY401 03/96→	DW151 ▲○	GW151 ▲○
47	8280.42S (TCA)	17173	8	145.00	Turbo Intercooled/V	378/514	BK490 BH790 (SE), 1.20mm	DH798 ○ [7]	GH795 ○
48	8280.01.000	17174	8	145.00	V	246/335	BK490 BH790 (SE), 1.20mm	DH793 ■○ (x8) DH79A ○ [16]	GH797 ○
49	8280.02.000/8280.02.024/ 8280.02.082/8280.02.109/ 8280.02.125- 135/8280.02.269/ 8280.02.274/8280.02.275/ 8280.02.289/8280.02.405	17174	8	145.00	V	259/352	BK490 BH790 (SE), 1.20mm	DH793 ■○ (x8) DH79A ○ [16]	GH797 ○
50	8280.02.120/8280.02.128	17174	8	145.00	V	259/352	BK490 BH790 (SE), 1.20mm		
51	8280.22.048 8280.22.009 8280.22.007/8280.22.033/ 8280.22.054/8280.22.154 8280.22.201/8280.22.205	17174 17174 17174 17174	8 8 8 8	145.00 145.00 145.00 145.00	Turbo/V Turbo/V Turbo/V Turbo Intercooled/V	279/380 280/380 280/381 309/420	BK490 BH790 (SE), 1.20mm	DH799 ■○	GH796 ○
52	8280.42.001 8280.42.050 8280.42S.350	17174 17174 17174	8 8 8	145.00 145.00 145.00	Turbo Intercooled/V Turbo Intercooled/V Turbo Intercooled/V	350/476 350/480 375/514	BK490 BH790 (SE), 1.20mm	DH798 ○ [7]	GH795 ○

						 BH790 KD5001 JN310 JN311 JN796 JJ518
KD5001	JN796 (x2)	JJ518 (Cork)			KV477 [55]	
	JN310 (x16) JN311 (x16)	JH5062			HL5081 [14] KL137 [14] JE150 (x16) [51] [52]	
	JN310 (x16) JN311 (x16)				HL5080 [14] KL137 [14] HJ285 [13]	
	JN310 (x16) JN311 (x16)				HL5080 [14] KL137 [14] HJ285 [13]	
	JN310 (x16) JN311 (x16)					
	JN310 (x16) JN311 (x16)	JH5062			HL5080 [14]	
KD5002	JN310 (x16) JN311 (x16)	JH5062			HL5081 [14] KL137 [14] JE150 [51] [52]	

		cc			9			cc			9
110/6 AA-Dover	Diesel	5944	6	104.77	23						
130/7 AA-Dover	Diesel	6227	6	107.18	26						
150/6 CA-Dover	Diesel	5944	6	104.77	23						
158 cu.in.	Diesel	2589	3	106.69	2						
2501E, 2502E, 2503E/32D (158 cu.in.)	Diesel	2589	3	106.69	3						
2504E (175 cu.in.)/ND, 6Y	Diesel	2868	3	106.69	6						
2505E (192 cu.in.)/BSD 332 (192 cu.in.)	Diesel	3146	3	111.77	8						
256	Diesel	4195	4	111.77	17						
268 cu.in.	Diesel	4391	4	111.77	18						
2701E, 2706E	Diesel	3933	4	104.77	12						
2703E (330 cu.in.)/2708E (330 cu.in.)	Diesel	5410	6	100.00	19						
2704	Diesel	5942	6	104.77	21						
2704E, 2709E	Diesel	5942	6	104.77	22						
2711E	Diesel	4178	4	107.21	15						
2713E	Diesel	5981	6	104.77	24						
2715E (380)	Diesel	6227	6	107.21	27						
3.152	Diesel	2500	3	91.49	1						
32D (180 cu.in.)	Diesel	2950	3	106.69	7						
380 CID	Diesel	6223	6	107.21	25						
401 cu.in.	Diesel	6571	6	111.77	28						
401cu.in.	Diesel	6571	6	111.77	28						
40D (175 cu.in.)	Diesel	2867	3	106.69	5						
5 AA/254 CID	Diesel	4160	4	107.21	13						
590E	Diesel	5416	6	100.00	20						
592E	Diesel	3610	4	100.00	11						
6Y	Diesel	4195	4	106.69	16						
7A (175 cu.in.)	Diesel	2867	3	106.69	4						
7A (201cu.in.)	Diesel	3294	3	111.77	9						
90/5 AA-Dover	Diesel	4178	4	107.18	14						
BSD 333H	Diesel	3294	3	111.77	10						
BSD 444T	Diesel	4391	4	111.77	18						
BSD442	Diesel	4195	4	111.77	17						
RD	Diesel	4195	4	106.69	16						



21

9



21

9

230 A	01/75→12/84	6
231	01/75→12/81	2
233	01/75→12/81	2
234	01/75→04/83	6
333	01/75→12/81	4
334 Highway Tractor	01/75→12/83	8
335	10/75→09/78	4
420	10/75→12/80	7
515	10/75→09/78	9
530 A	01/75→12/83	10
531	01/75→12/81	9
532	10/75→09/78	9
535	10/75→09/78	9
654 County		16
2000		3
2100	01/65→12/74	3
2120	01/65→12/74	3
2150	01/71→12/74	3
2300	01/65→12/74	3
2600	01/75→12/81	2
2610	01/81→04/83	6
2910	05/83→02/90	6
3000		5
3120	01/65→12/74	5
3150	01/71→12/74	5
3190	01/65→12/74	5
3300	01/65→12/74	5
3310	01/65→12/74	5
3400	01/65→12/74	5
3500	01/65→12/74	5
3600	01/75→12/81	4
3610 Tractor	01/81→12/83	8
3900	01/75→12/81	4
3910	01/83→	8
3910 H	01/83→	8
4100	01/75→12/81	7
4600 7A Series	01/75→12/81	9
4610	01/81→12/90	10
4610 H		10
4610 SU	01/81→12/90	10
4830	07/90→	17
5000		16
5030	10/92→	17
5100	01/65→03/68	16
5110	08/87→10/91	17
5190	01/65→03/68	16
5200	01/67→03/68	16
5610	08/87→	17
5900	08/87→	17
6600	01/75→12/81	17
6610 (Switzerland only)	10/85→	18
6810	08/87→	18
7410	08/87→10/91	18
7600	01/75→12/81	18
7610	01/81→	18
7700	01/75→12/81	18
7710	08/87→	18
7810	02/88→10/91	28
8000		28
8100 Tractor	01/69→12/81	27
8200	01/68→07/92	28
8400	01/71→09/72	28
8530	03/90→	28
9000		28
9200	01/69→09/72	28
9600	10/72→07/76	28
Cargo 0609	01/82→01/96	14
Cargo 0709	01/82→01/96	14
Cargo 0712, 0713	05/81→01/87	26
Cargo 0809	01/82→01/96	14
Cargo 0809 K	01/82→01/96	14
Cargo 0812, 0813	05/81→01/87	26
Cargo 0913	01/82→01/96	26

Cargo 0915	01/82→01/96	23
Cargo 1013	01/82→06/94	26
Cargo 1113	01/82→01/96	26
Cargo 1115	01/82→01/96	23
Cargo 1215	01/82→01/96	23
D 200	01/69→12/70	15
D 300	01/69→12/70	15
D 300	01/69→12/70	24
D 400	01/69→12/70	15
D 400	01/69→12/70	24
D 500	01/69→12/70	15
D 500	01/69→12/70	24
D 550	01/69→12/70	15
D 550	01/69→12/70	24
D 600	01/69→12/70	24
D 0610	01/71→12/80	24
D 700	01/69→12/70	24
D 0710	01/71→12/80	24
D 750	01/69→12/70	24
D 0810	01/71→12/80	24
D 0910	01/71→12/81	24
D 1000	01/68→12/70	21
D 1010	01/71→12/80	24
D 1110	01/71→12/80	24
D 1114 D Series Trucks	01/75→12/80	21
D 1210	01/71→12/80	24
D 1314	01/71→12/80	21
D 1414	01/71→12/80	21
D 1614	01/71→12/80	21
D Series Trucks	01/65→12/68	19
D Series Trucks	01/65→11/69	12
D Series Trucks	01/65→11/69	22
D Series Trucks	01/65→12/69	20
DA 1610	01/71→12/80	24
DA 1710	01/71→12/80	24
DA 2014	01/71→12/80	21
DA 2114	01/74→12/80	21
DO 507	01/70→12/72	15
DO 607	01/71→12/80	15
DO 707	01/71→12/80	15
DO 807	01/71→12/80	15
DO 907	01/71→12/80	15
DT 1400	01/68→12/70	21
DT 1500	01/69→12/70	21
DT 2014	01/71→12/80	21
DT 2214	01/71→12/75	21
DT 2414	01/75→12/80	21
Industrial 255 cu.in.	01/69→12/81	15
Major Tractor	01/52→12/56	11
Power Major Tractor	01/57→12/65	11
R 192	01/70→	24
R 192 R Series Truck	01/68→12/70	21
R 226 R Series Truck	01/68→12/70	21
R 1010	01/71→12/74	24
R 1014 R Series Truck	01/71→12/82	21
R 1114 R Series Truck	01/71→12/82	21
Super Dexta Tractor		1
Super Major Tractor	01/57→12/65	11
Thames Trader	01/54→12/65	11
Thames Trader 6D (4-7 Ton)	01/55→12/65	20
TW20	01/79→12/82	28
TW30	01/79→12/82	28

FORD COMMERCIAL



cc



kW/PS

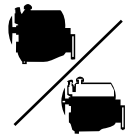

1	3.152	2500	3	91.49		22-33/ 30-45	AE200 (Fibre)	CE203 ■○	EE204 ■ Eng.1044DL→
2	158 cu.in.	2589	3	106.69			BJ040 (Fibre)	DJ040	EG140
3	2501E, 2502E, 2503E/ 32D (158 cu.in.)	2589	3	106.69			BJ050 (Fibre)	DJ050	EG140
4	7A (175 cu.in.)	2867	3	106.69			BJ040 (Fibre)	DJ040	EG140
5	40D (175 cu.in.)	2867	3	106.69			BJ050 (Fibre)	DJ050	EG140
6	2504E (175 cu.in.)/ND, 6Y	2868	3	106.69	/175 cu.in.		BJ040 (Fibre)	DJ040	EG140
7	32D (180 cu.in.)	2950	3	106.69			BJ040 (Fibre)	DJ040	EG140
8	2505E (192 cu.in.)/ BSD 332 (192 cu.in.)	3146	3	111.77			BS980 (Fibre)	DS980	EG140
9	7A (201cu.in.)	3294	3	111.77			BS980 (Fibre)	DS980	EG140
10	BSD 333H	3294	3	111.77	201 cu.in.		BJ060 (Fibre) 01/65→12/68 BS980 (Fibre) 01/69→	DJ060 01/65→12/68 DS980 01/69→	EG140
11	592E	3610	4	100.00			AD510 (Fibre)	CD510 01/57→12/65	FD511 01/57→12/61 FD512 01/62→12/65
12	2701E, 2706E	3933	4	104.77	240 cu.in.		BE960 (Fibre)	DE960	GE960
13	5 AA/254 CID	4160	4	107.21		59-66/ 80-90	BL780 (Fibre)	DL780	GL780
14	90/5 AA-Dover	4178	4	107.18		63-66/ 86-90	BL780 (Fibre)	DL780	GL780
15	2711E	4178	4	107.21	255 cu.in.		BE960 (Fibre)	DE960	GE960
16	6Y/RD	4195	4	106.69	256 cu.in.		BE740 (Fibre)	DE740 ■	EG160
17	256/BS0442	4195	4	111.77	256 cu.in.		BS990 (Fibre)	DS990 ■	EG160

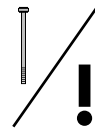
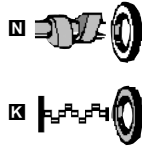
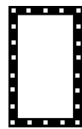
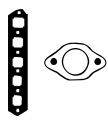

AD510



JH420



AE200



JJ121

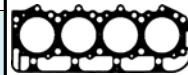

BE740

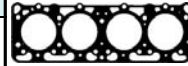

BE960



BJ040



BJ050



BJ060



BL780

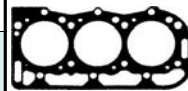

BS980



BS990

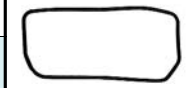

JM348



JM449



JM540



JM541



JN387

	JM348			<input checked="" type="checkbox"/> NA736 F 57.15x76.2x12.7mm <input checked="" type="checkbox"/> KT633 R (x2)[17]	
	JM540	JJ121	KG485 (x6)		
	JM540	JJ121	KG485 (x6)	<input checked="" type="checkbox"/> NA764 F 60.3x82.6x11.89mm, ACM <input checked="" type="checkbox"/> NA965 R 122.2x140.9x11.81mm, MVQ	
	JM540	JJ121	KG485 (x6)	<input checked="" type="checkbox"/> NA764 F 60.3x82.6x11.89mm, ACM <input checked="" type="checkbox"/> NA965 R 122.2x140.9x11.81mm, MVQ	
	JM540	JJ121	KG485 (x6)	<input checked="" type="checkbox"/> NA764 F 60.3x82.6x11.89mm, ACM <input checked="" type="checkbox"/> NA965 R 122.2x140.9x11.81mm, MVQ	
	JM540	JJ121	KG485 (x6)	<input checked="" type="checkbox"/> NA764 F 60.3x82.6x11.89mm, ACM <input checked="" type="checkbox"/> NA965 R 122.2x140.9x11.81mm, MVQ	
	JM540	JJ121	KG485 (x6)	<input checked="" type="checkbox"/> NA764 F 60.3x82.6x11.89mm, ACM <input checked="" type="checkbox"/> NA965 R 122.2x140.9x11.81mm, MVQ	
	JM540	JJ121	KG485 (x6)	<input checked="" type="checkbox"/> NA764 F 60.3x82.6x11.89mm, ACM <input checked="" type="checkbox"/> NA965 R 122.2x140.9x11.81mm, MVQ	
	JM540	JJ121	KG485 (x6)	<input checked="" type="checkbox"/> NA764 F 60.3x82.6x11.89mm, ACM <input checked="" type="checkbox"/> NA965 R 122.2x140.9x11.81mm, MVQ	
	JM540	JJ121	KG485 (x6)	<input checked="" type="checkbox"/> NA764 F 60.3x82.6x11.89mm, ACM <input checked="" type="checkbox"/> NA965 R 122.2x140.9x11.81mm, MVQ	
				<input checked="" type="checkbox"/> NA748 F (x2) 66.7x88.9x12.7mm, NBR <input checked="" type="checkbox"/> KT638 R (x2)[18]	<input checked="" type="checkbox"/> KG405 (x4) [14] S <input checked="" type="checkbox"/> 01/61 → 12/65 <input checked="" type="checkbox"/> KG406 (x4) [14] S <input checked="" type="checkbox"/> 01/61 → 12/65
	JM449	HC056 S		<input checked="" type="checkbox"/> NA5101 F (x2) 67x89x10mm, MVQ <input checked="" type="checkbox"/> KT638 R (x2)[18]	
	JN387	HC056 S		<input checked="" type="checkbox"/> NB688 F (x2) 66.7x89.3x9.52mm, MVQ	
	JN387	HC056 S		<input checked="" type="checkbox"/> NB688 F (x2) 66.7x89.3x9.52mm, MVQ <input checked="" type="checkbox"/> KT638 R (x2)	
	JM449	HC056 S		<input checked="" type="checkbox"/> NA5101 F 67x89x10mm, MVQ <input checked="" type="checkbox"/> KT638 R (x2)[18]	
	JM541	JH420		<input checked="" type="checkbox"/> NA764 F 60.3x82.6x11.89mm, ACM <input checked="" type="checkbox"/> NA965 R 122.2x140.9x11.81mm, MVQ	
	JM541	JH420		<input checked="" type="checkbox"/> NA764 F 60.3x82.6x11.89mm, ACM <input checked="" type="checkbox"/> NA965 R 122.2x140.9x11.81mm, MVQ	

FORD COMMERCIAL



cc



kW/PS

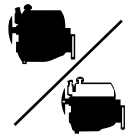

18	268 cu.in. BSD 444T	4391 4391	4 4	111.77 111.77	7600,7700 268 cu.in./Turbo		BS990 (Fibre)	DS990 ■	EG160
19	2703E (330 cu.in.)/ 2708E (330 cu.in.)	5410	6	100.00	Vertical, Inclined		BD600 (Fibre)	DD600	GD600
20	590E	5416	6	100.00			AD490 (Fibre) 01/57→12/65 BD600 (Fibre) 01/66→12/69	CD490 01/57→12/65 DD600 01/66→12/69	FD491 01/57→12/65 GD600 01/66→12/69
21	2704	5942	6	104.77	360 cu.in./Turbo		BD600 (Fibre) 01/73→	DD600 01/73→	FV670 08/69→12/72 GD600 01/73→
22	2704E, 2709E	5942	6	104.77	Vertical, Inclined		BD600 (Fibre)	DD600	GD600
23	110/6 AA-Dover 150/6 CA-Dover	5944 5944	6 6	104.77 104.77		81/110 110/150	BN500 (Fibre)	DN500	GN500
24	2713E	5981	6	104.77	365 cu.in. Parent Block		BD600 (Fibre) 01/69→12/72	DD600 01/69→12/72	GD600 01/69→12/72 FV670 01/73→
25	380 CID	6223	6	107.21		85-94/ 116-128	BD600 (Fibre)	DD600	GD600
26	130/7 AA-Dover	6227	6	107.18		94/128	BN510 (Fibre)	DN510	GN510
27	2715E (380)	6227	6	107.21	/D Series Parent Block		BD600 (Fibre)	DD600	GD600
28	401 cu.in. 401 cu.in. 401cu.in.	6571 6571 6571	6 6 6	111.77 111.77 111.77	401 cu.in. TW20,TW30/Turbo		AA5150 (Graphite), 1.30mm	DV971 ■	

	JM541	JH420		<input checked="" type="checkbox"/> NA764 60.3x82.6x11.89mm, ACM <input checked="" type="checkbox"/> NA965 122.2x140.9x11.81mm, MVQ	AD490 BD600 BN500 BN510 BS990 JA468 JM450 JM541 JN388 JH420
JA468 (x2)	JM450	HC057	HR629	<input checked="" type="checkbox"/> NA5101 (x2) 67x89x10mm, MVQ <input checked="" type="checkbox"/> KT638 (x2) [18]	
JA468 (x2) 01/66→12/69	JM450 01/66→12/69	HC057 01/66→12/69	HR629	<input checked="" type="checkbox"/> KT638 (x2) [18] <input checked="" type="checkbox"/> NA748 66.7x88.9x12.7mm, NBR 01/57→12/65 <input checked="" type="checkbox"/> NA5101 (x2) 67x89x10mm, MVQ 01/66→12/69	
JA468 (x2)	JM450	HC057	HR629	<input checked="" type="checkbox"/> NA5101 (x2) 67x89x10mm, MVQ <input checked="" type="checkbox"/> KT638 (x2) [18]	
JA468 (x2)	JM450	HC057	HR629	<input checked="" type="checkbox"/> NA5101 (x2) 67x89x10mm, MVQ <input checked="" type="checkbox"/> KT638 (x2) [18]	
	JN388	HC429		<input checked="" type="checkbox"/> NB688 (x2) 66.7x89.3x9.52mm, MVQ <input checked="" type="checkbox"/> KT638 (x2)	
JA468 (x2)	JM450	HC057	HR629	<input checked="" type="checkbox"/> NB688 (x2) 66.7x89.3x9.52mm, MVQ <input checked="" type="checkbox"/> KT638 (x2) [18]	
JA468 (x2)		HC057	HR629	<input checked="" type="checkbox"/> NA5101 67x89x10mm, MVQ	
	JN388	HC429		<input checked="" type="checkbox"/> NB688 66.7x89.3x9.52mm, MVQ <input checked="" type="checkbox"/> KT638 (x2)	
JA468 (x2)	JM450	HC057	HR629	<input checked="" type="checkbox"/> NA5101 67x89x10mm, MVQ <input checked="" type="checkbox"/> KT638 (x2)	
	LB096			<input checked="" type="checkbox"/> NA764 60.3x82.6x11.89mm, ACM <input checked="" type="checkbox"/> NA965 122.2x140.9x11.81mm, MVQ	

GARDNER



cc







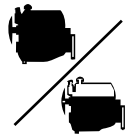

∅

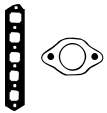

kW/PS

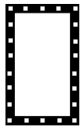

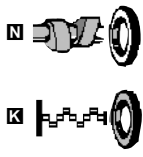
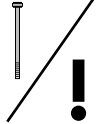
1	6HLX	10450	6	120.65	Horizontal		AH010 (x2)		
2	6HLXB	10450	6	120.65	Horizontal		AH010 (x2)		
3	6HLXCT	10450	6	120.65	Horizontal Turbo		AH010 (x2)		
4	6LX	10450	6	120.65	Anti clockwise rotation		AH010 (x2)	CH010 ■○	FH010 [7]
5	6LXB	10450	6	120.65			AH010 (x2)	CH010 ■○	FH010 [7]
6	6LXC	10450	6	120.65			AH010 (x2)	CH010 ■○	
7	6LXCT	10450	6	120.65	Turbo		AH010 (x2)		

						 AH010



DK10KV	Diesel	10178	6	120.00	12
DK10KVT	Diesel	10178	6	120.00	13
DK20	Diesel	10178	6	120.00	13
DK20T	Diesel	10178	6	120.00	13
EB100	Diesel	9036	6	115.00	9
EB200	Diesel	9036	6	115.00	9
EB300	Diesel	9838	6	120.00	11
EC100	Diesel	5010	6	97.00	1
ED100	Diesel	11581	6	128.00	14
EF100	Diesel	13804	8	130.00	16
EF300	Diesel	14232	8	132.00	17
EF500	Diesel	15459	8	135.00	18
EF550	Diesel	16260	8	135.00	20
EF700	Diesel	15920	8	137.00	19
EF-750	Diesel	16745	8	137.00	21
EH100	Diesel	5871	6	105.00	2
EH300	Diesel	6211	6	108.00	3
EH500	Diesel	6211	6	108.00	4
EH700	Diesel	6443	6	110.00	5
EK100	Diesel	13267	6	137.00	15
EL100	Diesel	7862	6	116.00	8
EM100	Diesel	9419	6	124.00	10
EV700	Diesel	19900	10	137.00	22
H06C	Diesel	6485	6	108.00	6
H07C	Diesel	6728	6	110.00	7





21

9



21

9

AM101	01/70→12/80	13	FS604 Cargo Truck	01/81→	20
AM101 Rainbow Bus	01/72→12/85	2	FS630 Truck	01/81→	21
AM141	01/70→12/80	13	FS633 Truck	01/81→	21
AM201	01/70→12/80	13	FS634 Truck	01/81→	21
AM241	01/70→12/80	13	FS636 Truck	01/81→	21
AM300	01/70→12/80	13	FW609 Cargo Truck	01/81→	20
AM340	01/70→12/80	13	GD172 Truck	01/83→12/90	7
AM400	01/70→12/80	13	GD174 Truck	01/83→12/90	7
AM440	01/70→12/80	13	H335 Tractor	01/70→12/80	13
BG Truck	01/70→12/80	12	H335 Tractor	01/70→12/81	13
BX300 Rainbow Bus	01/72→12/85	2	H335 Tractor	01/71→12/86	14
BX320 Rainbow Bus	01/72→12/85	2	H435 Tractor	01/70→12/80	13
BX340 Rainbow Bus	01/72→12/85	2	H435 Tractor	01/70→12/81	13
BX400 Rainbow Bus	01/72→12/85	2	H435 Tractor	01/71→12/86	14
BX420 Rainbow Bus	01/72→12/85	2	HE320	01/71→12/86	11
BY300 Bus	01/71→12/86	11	HE335	01/78→12/86	14
BY320 Bus	01/71→12/86	11	HE340 Tractor Truck	01/71→12/82	16
BY400 Bus	01/71→12/86	11	HE345 Tractor Truck	01/71→12/82	16
BY420 Bus	01/71→12/86	11	HE346 Tractor Truck	01/71→12/82	16
BY421 Bus	01/71→12/86	11	HE356 Tractor Truck	01/76→12/81	18
BY520 Bus	01/70→12/80	13	HE366 Tractor Truck	01/76→12/79	19
BY520 Bus	01/70→12/81	13	HE435	01/78→12/86	14
BY520 Bus	01/71→12/86	14	HE445 Tractor Truck	01/71→12/82	16
BY540 Bus	01/70→12/80	13	HH130 Tractor	01/70→12/80	13
BY540 Bus	01/70→12/81	13	HH130 Tractor	01/70→12/81	13
BY540 Bus	01/71→12/86	14	HH130 Tractor	01/71→12/86	14
BY620 Bus	01/70→12/80	13	HH230 Tractor	01/70→12/80	13
BY620 Bus	01/70→12/81	13	HH230 Tractor	01/70→12/81	13
BY620 Bus	01/71→12/86	14	HH230 Tractor	01/71→12/86	14
EZ321	01/71→12/86	11	HH330 Tractor	01/70→12/80	13
FB185 Ranger 7E Truck	01/78→12/84	8	HH330 Tractor	01/70→12/81	13
FB187 Ranger 7E Truck	01/78→12/84	8	HH330 Tractor	01/71→12/86	14
FD151 Ranger 4S Truck	01/80→	4	HH335 Tractor	01/70→12/80	13
FD151 Truck	01/78→12/81	3	HH335 Tractor	01/70→12/81	13
FD152 Ranger 4S Truck	01/80→	4	HH335 Tractor	01/71→12/86	14
FD152 Truck	01/78→12/81	3	HH340 Tractor Truck	01/71→12/76	16
FD154 Ranger 4S Truck	01/80→	4	HH341 Tractor Truck	01/77→12/79	19
FD154 Truck	01/78→12/81	3	HH430 Tractor	01/70→12/80	13
FD156 Ranger 4S Truck	01/80→	4	HH430 Tractor	01/70→12/81	13
FD156 Truck	01/78→12/81	3	HH430 Tractor	01/71→12/86	14
FD162 Ranger 4S Crane Truck	01/84→	6	HH435 Tractor	01/70→12/80	13
FD164 Ranger 4S Crane Truck	01/84→	6	HH435 Tractor	01/70→12/81	13
FD165 Ranger 4S Crane Truck	01/84→	6	HH435 Tractor	01/71→12/86	14
FD166 Ranger 4S Crane Truck	01/84→	6	HH440 Tractor Truck	01/71→12/76	16
FD168 Ranger 4S Truck	11/83→12/86	6	HL500 Ranger Truck	01/72→12/85	2
FD171 Truck	01/83→12/90	7	Industrial		22
FD172 Truck	01/83→12/90	7	Industrial Container Truck	01/71→12/73	1
FD250 Forklift	01/75→12/80	13	Industrial Rainbow Light Bus	01/77→12/80	1
FE172 Truck	01/83→12/90	7	Industrial Ranger Cargo Truck	01/69→12/80	1
FE173 Truck	01/83→12/90	7	Industrial Ranger Concrete Mixer	01/70→12/78	1
FE174 Truck	01/83→12/90	7	Industrial Ranger Crane Truck	01/70→12/77	1
FE175 Truck	01/83→12/90	7	Industrial Ranger Dump Truck	01/69→12/74	1
FN600-609 Super Dolphin (10.75 ton)	01/83→	20	Industrial Ranger Fire Engine	01/71→12/75	1
FN604 Fire Engine	01/84→	20	Industrial Ranger Freezer Truck	01/73→12/74	1
FN634 Tractor	01/86→	21	Industrial Ranger Snow Plough	01/76→12/78	1
FN634 Truck	01/83→	21	Industrial Ranger Tank Truck	01/73→12/79	1
FN635 Tractor	01/86→	21	Industrial Ranger Vacuum Truck	01/76→12/82	1
FN635 Truck	01/83→	21	Industrial Tractor Truck	01/70→12/74	1
FN638 Tractor	01/86→	21	KA Tractor Truck	01/70→12/80	12
FN638 Truck	01/83→	21	KA340 Truck	01/71→12/78	16
FP609 Cargo Truck	01/81→	20	KB100 Truck	01/67→12/86	9
FR600 Dump Truck	01/81→	20	KB111	01/71→12/86	11
FR600-609 Super Dolphin (10.75 ton)	01/83→	20	KB111 Truck	01/67→12/86	9
FR600-609 Super Dolphin (10.75 ton)	01/83→	20	KB112	01/71→12/86	11
FR608 Cargo Truck	01/81→	20	KB113	01/71→12/86	11
FR609 Cargo Truck	01/81→	20	KB120 Crane Truck	01/67→12/86	9
FR630 Truck	01/83→	21	KB120 Truck	01/67→12/86	9
FR634 Truck	01/83→	21	KB121	01/71→12/86	11
FR635 Truck	01/83→	21	KB121 Crane Truck	01/67→12/86	9
FR636 Truck	01/83→	21	KB122	01/71→12/86	11
FR638 Truck	01/83→	21	KB202	01/71→12/86	11
FR639 Truck	01/83→	21	KB211	01/71→12/86	11
FS600 Concrete Mixer and Pump	01/81→	20	KB212	01/71→12/86	11



21

9

KB215	01/71→12/86	11
KB221	01/71→12/86	11
KB222	01/71→12/86	11
KB300 Truck	01/67→12/86	9
KB301 Truck	01/67→12/86	9
KB312 Truck	01/67→12/86	9
KB320 Truck	01/67→12/86	9
KB321 Truck	01/67→12/86	9
KB322	01/71→12/86	11
KB324	01/71→12/86	11
KB340 Truck	01/67→12/86	9
KB341 Truck	01/67→12/86	9
KB342	01/71→12/86	11
KB360 Truck	01/67→12/86	9
KB361 Truck	01/67→12/86	9
KB364	01/71→12/86	11
KB380 Truck	01/67→12/86	9
KB382	01/71→12/86	11
KB384	01/71→12/86	11
KB392	01/71→12/86	11
KB394	01/71→12/86	11
KB402	01/71→12/86	11
KB422	01/71→12/86	11
KB721	01/71→12/86	11
KB980	01/71→12/86	11
KD154 Ranger 4S Truck	01/80→	4
KF Truck	01/66→12/80	13
KF320 Truck	01/70→12/80	13
KF320 Truck	01/71→12/86	14
KF365 Truck	01/70→12/80	13
KF365 Truck	01/71→12/86	14
KF420 Truck	01/70→12/80	13
KF420 Truck	01/71→12/86	14
KF465 Truck	01/70→12/80	13
KF465 Truck	01/71→12/86	14
KF500	01/76→12/81	18
KF520	01/76→12/81	18
KF545	01/76→12/81	18
KF550	01/76→12/81	18
KF555	01/76→12/81	18
KF560	01/76→12/81	18
KF565	01/76→12/81	18
KF580	01/76→12/81	18
KF585	01/76→12/81	18
KF590	01/76→12/81	18
KF595	01/76→12/81	18
KF703 Truck	01/71→12/79	17
KF722 Truck	01/71→12/78	16
KF723 Truck	01/71→12/79	17
KF743 Truck	01/71→12/79	17
KF746 Truck	01/71→12/79	17
KF756 Truck	01/71→12/79	17
KF763 Truck	01/71→12/79	17
KF765 Truck	01/71→12/78	16
KF766 Truck	07/75→12/79	17
KF783 Truck	07/75→12/79	17
KF786 Truck	07/75→12/79	17
KF793 Truck	07/75→12/79	17
KF794 Truck	07/75→12/79	17
KF796 Truck	07/75→12/79	17
KF797 Truck	07/75→12/79	17
KF822 Truck	01/71→12/78	16
KF865 Truck	01/71→12/78	16
KF940	01/71→12/86	11
KF960	01/71→12/86	11
KH120	01/71→12/86	11
KJ300 Ranger Truck	01/72→12/85	2
KJ500 Ranger Truck	01/72→12/85	2
KJ560 Ranger Truck	01/72→12/85	2
KL500 Truck	01/72→12/85	2
KL501		21
KL520 Ranger Crane	01/72→12/85	2
KL520 Truck	01/72→12/85	2



21

9

KL521D		21
KL540 Truck	01/72→12/85	2
KL541		21
KL550 Truck	01/72→12/85	2
KL560 Truck	01/72→12/85	2
KL561		21
KL581 Truck SS	01/72→12/85	2
KQ500		21
KQ520D		21
KQ540		21
KQ560		21
KR120 Truck	01/72→12/85	2
KR220 Truck	01/72→12/85	2
KR300 Truck	01/72→12/85	2
KR320 Ranger 6 Truck	01/72→12/85	2
KR320 Truck	01/70→12/81	13
KR360 Ranger 6 Truck	01/72→12/85	2
KR365 Truck	01/70→12/81	13
KR400 Truck	01/72→12/85	2
KR420 Truck	01/70→12/81	13
KR420 Truck	01/72→12/85	2
KR460 Truck	01/72→12/85	2
KR465 Truck	01/70→12/81	13
LA500 Truck	01/72→12/85	2
LA520 Truck	01/72→12/85	2
LA540 Truck	01/72→12/85	2
LA560 Truck	01/72→12/85	2
LA600 Truck	01/72→12/85	2
LA620 Truck	01/72→12/85	2
LA640 Truck	01/72→12/85	2
LA660 Truck	01/72→12/85	2
LB500 Truck	01/78→12/81	3
LB520 Truck	01/78→12/81	3
LB560 Truck	01/78→12/81	3
LB600 Truck	01/78→12/81	3
LB620 Truck	01/78→12/81	3
LB660 Truck	01/78→12/81	3
LB700 Ranger Truck	01/78→12/84	8
LB720 Ranger Truck	01/78→12/84	8
LB760 Ranger Truck	01/78→12/84	8
RC300 Bus	01/70→12/80	13
RC300 Bus	01/70→12/81	13
RC300 Bus	01/71→12/77	14
RC320 Bus	01/70→12/80	13
RC320 Bus	01/70→12/81	13
RC320 Bus	01/71→12/77	14
RC320P Bus	01/70→12/80	13
RC320P Bus	01/70→12/81	13
RC321 Bus	01/70→12/81	13
RC321 Bus	01/71→12/77	14
RC400 Bus	01/70→12/80	13
RC400 Bus	01/70→12/81	13
RC400 Bus	01/71→12/77	14
RC420 Bus	01/70→12/80	13
RC420 Bus	01/70→12/81	13
RC420 Bus	01/71→12/77	14
RC421 Bus	01/70→12/80	13
RC421 Bus	01/70→12/81	13
RC421 Bus	01/71→12/77	14
RE100 Bus	01/68→12/79	9
RE120 Bus	01/68→12/79	9
RE140 Bus	01/68→12/79	9
RE200 Bus	01/68→12/79	9
RE220 Bus	01/68→12/79	9
RE240 Bus	01/68→12/79	9
RF300	01/71→12/86	11
RF320	01/71→12/86	11
RF400	01/71→12/86	11
RF420	01/71→12/86	11
RF720 Bus	01/70→12/80	13
RF720 Bus	01/70→12/81	13
RF720 Bus	01/71→12/86	14



21

9



21

9

RL100 Bus	01/70→12/75	1
RL300 Ranger Bus	01/72→12/85	2
RL320 Ranger Bus	01/72→12/85	2
RR192 Rainbow Bus	04/84→12/87	6
RS120 Bus	01/75→12/76	17
RS360 Bus	01/79→12/82	18
RU600-609 (10.75 ton) Super Dolphin	01/83→	20
RU607 Bus	01/82→	20
RV76R Bus	01/78→12/79	17
RV541 Bus	01/78→12/82	18
RV561 Bus	01/79→12/82	18
RV730 Bus	01/72→12/79	16
RV750 Bus	01/72→12/79	16
RV830 Bus	01/72→12/79	16
RV850 Bus	01/72→12/79	16
SH600-609 (10.75 ton) Super Dolphin	01/83→	20
SH601 Tractor	01/81→	20
SH601 Tractor Truck	08/81→12/82	18
TC Fire Engine	01/70→12/80	12
TC Tractor Truck	01/70→12/80	12
TC Truck	01/66→12/80	13
TC362 Truck	01/70→12/80	13
TC362 Truck	01/70→12/81	13
TC362 Truck	01/71→12/86	14
TC462 Truck	01/70→12/80	13
TC462 Truck	01/70→12/81	13
TC462 Truck	01/71→12/86	14
TC482 Truck	01/75→12/76	17
TC545 Truck	01/76→12/77	18
TC562 Tractor Truck	01/76→12/81	19
TC565 Truck	01/76→12/77	18
TC582 Tractor Truck	01/76→12/81	19
TC585 Truck	01/77→12/81	18
TC701 Truck	07/71→12/78	16
TC702 Truck	01/75→12/76	17
TC721 Truck	07/71→12/78	16
TC722 Truck	01/75→12/76	17
TC741 Truck	07/71→12/78	16
TC742 Truck	01/75→12/76	17
TC746 Truck	01/75→12/76	17
TC761 Truck	07/71→12/78	16
TC762 Truck	01/75→12/76	17
TC781 Truck	07/71→12/78	16
TC861 Truck	07/71→12/78	16
WB311 Ranger Truck	01/72→12/85	2
WB321 Ranger Truck	01/72→12/85	2
WP325 Truck	01/76→	18
ZC120	01/78→12/86	14
ZG150 Truck	01/70→12/80	13
ZG150 Truck	01/70→12/81	13
ZG150 Truck	01/71→12/86	14
ZH100	01/71→12/86	11
ZL100	01/71→12/86	11
ZL300	01/71→12/86	11
ZM Truck	01/66→12/80	13
ZM Truck	01/70→12/80	12
ZM101 Truck	01/70→12/77	13
ZM101 Truck	01/71→12/86	14
ZM141 Truck	01/70→12/77	13
ZM141 Truck	01/71→12/86	14
ZM201 Truck	01/70→12/77	13
ZM201 Truck	01/71→12/86	14
ZM241 Truck	01/70→12/77	13
ZM241 Truck	01/71→12/86	14
ZM300 Truck	01/70→12/77	13
ZM300 Truck	01/71→12/86	14
ZM340 Truck	01/70→12/77	13
ZM340 Truck	01/71→12/86	14
ZM400 Truck	01/70→12/77	13
ZM400 Truck	01/71→12/86	14
ZM440 Truck	01/70→12/77	13
ZM440 Truck	01/71→12/86	14
ZM500 Truck	01/76→12/81	18

ZM500 Truck	03/77→12/81	19
ZM540 Truck	01/76→12/81	18
ZM702 Truck	01/71→12/82	16
ZM703 Truck	01/71→12/82	16
ZM704 Truck	07/75→12/79	17
ZM705 Truck	07/75→12/79	17
ZM742 Truck	01/71→12/82	16
ZM743 Truck	01/71→12/82	16
ZM744 Truck	09/79→12/81	17
ZM763 Truck	01/71→12/82	16
ZM764 Truck	09/79→12/81	17
ZM802 Truck	01/71→12/82	16
ZM842 Truck	01/71→12/82	16
ZR300	01/78→12/86	14
ZT300	01/71→12/86	11
ZT320	01/71→12/86	11



cc



Ø



kW/PS

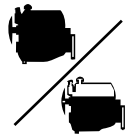

1	EC100	5010	6	97.00			BJ980 (Fibre) →12/71		GJ980 ○ →12/71
2	EH100	5871	6	105.00				DJ280 ○	GJ280 ○
3	EH300	6211	6	108.00				DJ270 ■○	
4	EH500	6211	6	108.00			BK960 (Fibre) 01/87→		GK960 ○ 01/87→
5	EH700	6443	6	110.00		121/165	BK960 (Fibre) 01/78→		GK960 ○ 01/78→
6	HO6C	6485	6	108.00					
7	HO7C	6728	6	110.00			BK960 (Fibre)		
8	EL100	7862	6	116.00					GR800
9	EB100/EB200	9036	6	115.00					
10	EM100	9419	6	124.00		158/215	BV590 (SE)		
11	EB300	9838	6	120.00					GC150 ○
12	DK10KV	10178	6	120.00					
13	DK10KVT DK20 DK20T	10178 10178 10178	6 6 6	120.00 120.00 120.00	Turbo Turbo				
14	ED100	11581	6	128.00					
15	EK100	13267	6	137.00		191/260	BJ970 (Fibre) (x2) 01/76→06/79	DJ970 ■○ 01/76→06/79	GJ970 ○ 01/76→06/79
16	EF100	13804	8	130.00	v				
17	EF300	14232	8	132.00			BR710 (Fibre) (x2) 01/77→12/81		
18	EF500	15459	8	135.00			BN520 (Fibre) (x2) 01/77→12/81		GN520 01/77→12/81
19	EF700	15920	8	137.00			BN520 (Fibre) (x2) 07/79→12/81		GN520 07/79→12/81
20	EF550	16260	8	135.00			BN520 (Fibre) (x2)		GN521
21	EF-750	16745	8	137.00			BN520 (Fibre) (x2)		GN521
22	EV700	19900	10	137.00					GR810 ○

JC232 ■ (x6) →12/71 ⊙JE737 →12/71	JN425	HC426 ■		<input checked="" type="checkbox"/> NJ297 ■ 58x75x9mm, NBR →12/71 <input checked="" type="checkbox"/> NJ302 ■ 100x120x13mm, MVQ →12/71			
JC232 ■ (x6) ⊙JE737	JN425	HC426 ■		<input checked="" type="checkbox"/> NJ297 ■ 58x75x9mm, NBR <input checked="" type="checkbox"/> NJ302 ■ 100x120x13mm, MVQ <input checked="" type="checkbox"/> NJ463 ■ 90x110x13mm, NBR			
JC232 ■ (x6) ⊙JE737	JN425			<input checked="" type="checkbox"/> NJ297 ■ 58x75x9mm, NBR <input checked="" type="checkbox"/> NJ303 ■ 106x126x12mm, MVQ			
JC355 ■ (x6) 01/87→ JC354 ■ (x6) 01/87→ ⊙JE737 01/87→	JN508 01/87→			<input checked="" type="checkbox"/> NJ298 ■ 65x88x12mm, NBR <input checked="" type="checkbox"/> NJ303 ■ 106x126x12mm, MVQ 01/87→			
JC355 ■ (x6) 01/78→ JC354 ■ (x6) 01/78→ ⊙JE737 01/78→	JN508 01/78→	JJ252 ■		<input checked="" type="checkbox"/> NJ303 ■ 106x126x12mm, MVQ <input checked="" type="checkbox"/> NJ298 ■ 65x88x12mm, NBR 01/78→			
	JN508		PB182 (x12)	<input checked="" type="checkbox"/> NJ298 ■ 65x88x12mm, NBR <input checked="" type="checkbox"/> NJ303 ■ 106x126x12mm, MVQ			
	JN508		PB182 (x12)	<input checked="" type="checkbox"/> NJ298 ■ 65x88x12mm, NBR <input checked="" type="checkbox"/> NJ303 ■ 106x126x12mm, MVQ			
				<input checked="" type="checkbox"/> NJ931 ■ 75x100x13mm, ACM			
				<input checked="" type="checkbox"/> NJ300 ■ 80x105x13mm, ACM 01/67→12/72 <input checked="" type="checkbox"/> NJ305 ■ 125x155x14mm, MVQ 01/67→12/72			
				<input checked="" type="checkbox"/> NJ931 ■ 75x100x13mm, ACM			
				<input checked="" type="checkbox"/> NJ300 ■ 80x105x13mm, ACM			
				<input checked="" type="checkbox"/> NJ300 ■ 80x105x13mm, ACM →01/73 <input checked="" type="checkbox"/> NJ305 ■ 125x155x14mm, MVQ →01/73			
				<input checked="" type="checkbox"/> NJ300 ■ 80x105x13mm, ACM <input checked="" type="checkbox"/> NJ305 ■ 125x155x14mm, MVQ			
				<input checked="" type="checkbox"/> NJ300 ■ 80x105x13mm, ACM <input checked="" type="checkbox"/> NJ305 ■ 125x155x14mm, MVQ			
				<input checked="" type="checkbox"/> NJ305 ■ 125x155x14mm, MVQ <input checked="" type="checkbox"/> NJ619 ■ 70x95x13mm, NBR 01/76→06/79			
				<input checked="" type="checkbox"/> NJ308 27x47x10mm, NBR 01/72→12/82 <input checked="" type="checkbox"/> NJ301 ■ 96x124.2x14mm, NBR 01/72→12/82 <input checked="" type="checkbox"/> NJ306 ■ 130x161x14mm, MVQ 01/72→12/82			
				<input checked="" type="checkbox"/> NJ301 ■ 96x124.2x14mm, NBR 01/77→12/81			
				<input checked="" type="checkbox"/> NJ301 ■ 96x124.2x14mm, NBR			
				<input checked="" type="checkbox"/> NJ301 ■ 96x124.2x14mm, NBR			
				<input checked="" type="checkbox"/> NJ301 ■ 96x124.2x14mm, NBR			
				<input checked="" type="checkbox"/> NJ301 ■ 96x124.2x14mm, NBR			
				<input checked="" type="checkbox"/> NJ301 ■ 96x124.2x14mm, NBR			



cc



kW/PS

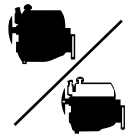

1	4BB1	3595	4	102.00			BK040 (Fibre)		GK041
2	4BD1	3856	4	102.00		78/106	BK040 (Fibre)	DK042 01/82→	GK043 →12/81 GK042 01/82→
3	4BD1 4BD1T	3856 3856	4 4	102.00 102.00		78/106 85/116	BK040 (Fibre)	DK042 01/82→	GK043 01/79→12/81 GK042 01/82→
4	6BB1	5393	6	102.00			BR550 (MLS)	DR555 ■	GR555 ○
5	6BD1	5785	6	102.00		110/150	BR550 (MLS)	DR555 ■ 01/76→11/81 DR556 ■ 12/81→12/83 DR557 ■ 01/84→08/86 DR558 ○ 09/86→11/86	GR555 ○ 01/76→11/81 GR556 ○ [7] 12/81→12/83 GR557 ○ [7] 01/84→08/86
6	6BD1 6BD1T	5785 5785	6 6	102.00 102.00	Turbo	110/150 132/180	BR550 (MLS)	DR555 ■ 01/76→11/81 DR556 ■ 12/81→12/83 DR557 ■ 01/84→08/86	GR555 ○ 01/76→11/81 GR556 ○ [7] 12/81→12/83 GR557 ○ [7] 01/84→08/86
7	DA120	6125	6	100.00					FX361
8	DA640	6373	6	102.00					
9	6BG1	6494	6	105.00		125/170	BR550 (MLS) 08/86→12/87		GR550 08/86→12/87
10	6SA1	8413	6	115.00		145/197			
11	6RA1	12023	6	135.00		170/231	BJ260 (SE) (x2)	DJ262 ■	GJ262
12	10PA1	12464	10	115.00	v				
13	6RB1	13741	6	135.00		190/258	BJ260 (SE) (x2)	DJ262 ■	GJ262
14	6RB1	13741	6	135.00		190/258	BJ260 (SE) (x2)	DJ262 ■	GJ262

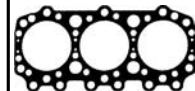
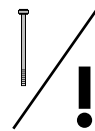
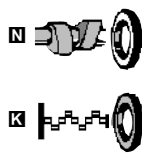
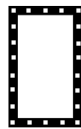
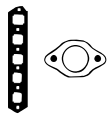

BJ260



BK040



BR550



















JC336



JJ244

JC336 (x2)		JJ177 01/76 →	PA208 (x8)	<input checked="" type="checkbox"/> NJ231 60x82x12mm, MVQ 01/76 → <input checked="" type="checkbox"/> NJ232 100x135x15mm, MVQ 01/76 →	
JC336 (x2)	JN504	JJ177 JJ376 01/82 →	PA208 (x8)	<input checked="" type="checkbox"/> NJ231 60x82x12mm, MVQ <input checked="" type="checkbox"/> NJ232 100x135x15mm, MVQ	
JC336 (x2)	JN504	JJ177 JJ376 08/82 →	PA208 (x8)	<input checked="" type="checkbox"/> NJ231 60x82x12mm, MVQ <input checked="" type="checkbox"/> NJ232 100x135x15mm, MVQ	
JC329 01/73 → JC336 (x3) 01/73 →	JN505 01/73 →	JJ244 01/73 →	PA208 (x12) 01/73 →	<input checked="" type="checkbox"/> NJ231 60x82x12mm, MVQ <input checked="" type="checkbox"/> NJ232 100x135x15mm, MVQ	
JC329 JC336 (x3) 01/76 →12/83	JN708 01/84 →	JJ244	PA208 (x12)	<input checked="" type="checkbox"/> NJ937 60x82x10mm, ACM 09/86 →11/86 <input checked="" type="checkbox"/> NJ231 60x82x12mm, MVQ →12/84 <input checked="" type="checkbox"/> NJ232 100x135x15mm, MVQ 01/76 →11/81 <input checked="" type="checkbox"/> NJ596 105x135x14mm, MVQ 09/86 →11/86	
JC329 JC336 (x3) 01/76 →12/83	JN708 01/84 →	JJ244	PA208 (x12)	<input checked="" type="checkbox"/> NJ937 60x82x10mm, ACM 09/86 →11/86 <input checked="" type="checkbox"/> NJ231 60x82x12mm, MVQ 01/76 →12/84 <input checked="" type="checkbox"/> NJ232 100x135x15mm, MVQ 01/76 →11/81 <input checked="" type="checkbox"/> NJ596 105x135x14mm, MVQ 09/86 →11/86	
			PA977 (x12) 01/70 →	<input checked="" type="checkbox"/> NJ233 70x92x12mm, NBR <input checked="" type="checkbox"/> NJ236 70x92x12mm, NBR 01/70 →	
			PA977 (x12) 01/70 →	<input checked="" type="checkbox"/> NJ233 70x92x12mm, NBR 01/69 → <input checked="" type="checkbox"/> NJ236 70x92x12mm, NBR 01/70 →	
JC329	JN708	JJ244		<input checked="" type="checkbox"/> NJ937 60x82x10mm, ACM <input checked="" type="checkbox"/> NJ596 105x135x14mm, MVQ	
				<input checked="" type="checkbox"/> NJ790 120x153x15mm, MVQ <input checked="" type="checkbox"/> NJ791 120x150x15mm, MVQ	
	JN674 (x2)		PA894 (x12)	<input checked="" type="checkbox"/> NJ790 120x153x15mm, MVQ	
	JN674 (x2)		PA894 (x24)		
	JN674 (x2)		PA894 (x12)		

		cc			9			cc			9
203 A/61	Diesel	11548	6	130.00	64	8060.25V.4080	Diesel	5861	6	104.00	27
203 A/61.000	Diesel	11548	6	130.00	64	8060.25V.4800	Diesel	5861	6	104.00	27
203 H 61	Diesel	11548	6	130.00	65	8060.45.4100	Diesel	5861	6	104.00	27
203.000	Diesel	10676	6	125.00	62	8060.45.4100 TCA	Diesel	5861	6	104.00	27
213 H	Diesel	4678	6	95.00	15	8060.45.4180	Diesel	5861	6	104.00	27
213.000	Diesel	4678	6	95.00	15	8060.45.4300/8060.45.4400/	Diesel	5861	6	104.00	27
220 H/8200.11	Diesel	9161	6	120.00	42	8060.45L.4400					
310 H/61	Diesel	11548	6	130.00	63	8060.45.4700	Diesel	5861	6	104.00	27
8040.04.200	Diesel	3666	4	103.00	1	8060.45.4702	Diesel	5861	6	104.00	27
8040.05.200	Diesel	3908	4	104.00	3	8060.45.4704	Diesel	5861	6	104.00	27
8040.05.203	Diesel	3908	4	104.00	3	8060.45.4706	Diesel	5861	6	104.00	27
8040.05.230	Diesel	3908	4	104.00	3	8060.45.4708	Diesel	5861	6	104.00	27
8040.05.232	Diesel	3908	4	104.00	4	8060.45.5250	Diesel	5861	6	104.00	27
8040.05.233	Diesel	3908	4	104.00	3	8060.45.5251	Diesel	5861	6	104.00	27
8040.05.235	Diesel	3908	4	104.00	3	8060.45.5255	Diesel	5861	6	104.00	27
8040.05.4990	Diesel	3908	4	104.00	7	8060.45.6090	Diesel	5861	6	104.00	27
8040.25 B.4200	Diesel	3908	4	104.00	6	8060.45A.4100	Diesel	5861	6	104.00	27
8040.25.200	Diesel	3908	4	104.00	8	8060.45B 5100	Diesel	5861	6	104.00	28
8040.25.220	Diesel	3908	4	104.00	9	8060.45B.4300/	Diesel	5861	6	104.00	26
8040.25.230 R	Diesel	3908	4	104.00	5	8060.45R.4245					
8040.25.4990	Diesel	3908	4	104.00	2	8060.45K.6090	Diesel	5861	6	104.00	26
8040.25B.4220	Diesel	3908	4	104.00	6	8060.45R.5000	Diesel	5861	6	104.00	27
8040.25X.4000	Diesel	3908	4	104.00	2	8060.45R.5001	Diesel	5861	6	104.00	27
8040.45.4000	Diesel	3908	4	104.00	6	8060.45R.5003	Diesel	5861	6	104.00	27
8040.45.4180	Diesel	3908	4	104.00	10	8060.45R.5005	Diesel	5861	6	104.00	27
8040.45.4380	Diesel	3908	4	104.00	2	8060.45R.5050	Diesel	5861	6	104.00	27
8040.45.5200	Diesel	3908	4	104.00	2	8060.45R.5051	Diesel	5861	6	104.00	27
8040.45D.5100	Diesel	3908	4	104.00	2	8060.45S TCA	Diesel	5861	6	104.00	27
8040.45X.4180	Diesel	3908	4	104.00	2	8060.45S.6000	Diesel	5861	6	104.00	27
806 A (8060.01/.11)	Diesel	4678	6	95.00	16	8060.45S.6203	Diesel	5861	6	104.00	27
8060.02.001	Diesel	5184	6	100.00	17	8060.45S.6800	Diesel	5861	6	104.00	27
8060.02.003	Diesel	5184	6	100.00	17	8060.45S.7200	Diesel	5861	6	104.00	28
8060.04	Diesel	5499	6	103.00	19	8062.24.070	Diesel	5499	6	103.00	21
8060.04.055	Diesel	5499	6	103.00	19	8200.01.220 - 620.001/	Diesel	9161	6	120.00	42
8060.04.060	Diesel	5500	6	103.00	24	021 - 8200.11					
8060.04.070	Diesel	5499	6	103.00	19	8200.02	Diesel	9820	6	122.00	57
8060.04.620	Diesel	5499	6	103.00	19	8200.03	Diesel	10308	6	125.00	60
8060.04.621	Diesel	5499	6	103.00	19	8200.13	Diesel	10308	6	125.00	61
8060.04.630	Diesel	5500	6	103.00	23	8210.02	Diesel	13798	6	137.00	78
8060.04.639	Diesel	5500	6	103.00	23	8210.02.067	Diesel	13798	6	137.00	78
8060.04.658	Diesel	5499	6	103.00	19	8210.02.069	Diesel	13798	6	137.00	78
8060.04.660	Diesel	5500	6	103.00	24	8210.02.371	Diesel	13798	6	137.00	78
8060.04.669	Diesel	5500	6	103.00	24	8210.02.373	Diesel	13798	6	137.00	78
8060.04.670	Diesel	5500	6	103.00	23	8210.02.377	Diesel	13798	6	137.00	78
8060.04.672	Diesel	5500	6	103.00	23	8210.02.393	Diesel	13798	6	137.00	78
8060.04.675	Diesel	5500	6	103.00	23	8210.02.440	Diesel	13798	6	137.00	78
8060.04.689	Diesel	5500	6	103.00	24	8210.02.441	Diesel	13798	6	137.00	78
8060.05	Diesel	5861	6	104.00	29	8210.02.731	Diesel	13798	6	137.00	78
8060.05.200	Diesel	5868	6	104.00	32	8210.22.105	Diesel	13798	6	137.00	79
8060.05.246	Diesel	5868	6	104.00	33	8210.22.171	Diesel	13798	6	137.00	79
8060.05.270	Diesel	5861	6	104.00	29	8210.22.175	Diesel	13798	6	137.00	79
8060.05.280	Diesel	5861	6	104.00	29	8210.22.183	Diesel	13798	6	137.00	79
8060.05.285	Diesel	5861	6	104.00	29	8210.22.210	Diesel	13798	6	137.00	79
8060.05.289	Diesel	5861	6	104.00	29	8210.22.236	Diesel	13798	6	137.00	79
8060.24	Diesel	5500	6	103.00	22	8210.22.269	Diesel	13798	6	137.00	79
8060.24.601	Diesel	5500	6	103.00	25	8210.22.317	Diesel	13798	6	137.00	79
8060.24.670	Diesel	5499	6	103.00	20	8210.22.327	Diesel	13798	6	137.00	79
8060.24.671	Diesel	5499	6	103.00	20	8210.22.385	Diesel	13798	6	137.00	79
8060.24.678	Diesel	5500	6	103.00	25	8210.22.511	Diesel	13798	6	137.00	79
8060.25.600	Diesel	5868	6	104.00	34	8210.22.521	Diesel	13798	6	137.00	79
8060.25.669	Diesel	5861	6	104.00	30	8210.22.523	Diesel	13798	6	137.00	79
8060.25.670	Diesel	5861	6	104.00	31	8210.22.525	Diesel	13798	6	137.00	79
8060.25.678	Diesel	5861	6	104.00	30	8210.22.535	Diesel	13798	6	137.00	79
8060.25.679	Diesel	5861	6	104.00	30	8210.22.537	Diesel	13798	6	137.00	79
8060.25R 4200	Diesel	5861	6	104.00	27	8210.22.569	Diesel	13798	6	137.00	79
8060.25R 4300	Diesel	5861	6	104.00	27	8210.22.800	Diesel	13798	6	137.00	77
8060.25R.4200 LTC	Diesel	5861	6	104.00	27	8210.22.869	Diesel	13798	6	137.00	79
8060.25R.4280	Diesel	5861	6	104.00	27	8210.22X.069	Diesel	13798	6	137.00	79
8060.25R.4750	Diesel	5861	6	104.00	27	8210.22X.235	Diesel	13798	6	137.00	79
8060.25R.4755	Diesel	5861	6	104.00	27	8210.22X.523	Diesel	13798	6	137.00	79
8060.25R.4760	Diesel	5861	6	104.00	27	8210.22X.575	Diesel	13798	6	137.00	79
8060.25R.4764	Diesel	5861	6	104.00	27	8210.42	Diesel	13798	6	137.00	80
8060.25V.4000	Diesel	5868	6	104.00	35	8210.42 TCA	Diesel	13798	6	137.00	80

		CC			9			CC			9
8210.42.061	Diesel	13798	6	137.00	80	8360.05.673	Diesel	8102	6	115.00	41
8210.42.073	Diesel	13798	6	137.00	80	8360.46	Diesel	7685	6	112.00	38
8210.42.101	Diesel	13798	6	137.00	80	8360.46.417	Diesel	7685	6	112.00	38
8210.42.115	Diesel	13798	6	137.00	81	8360.46.417 (TCA)	Diesel	7685	6	112.00	38
8210.42.151	Diesel	13798	6	137.00	84	8360.46R.416 (TCA)	Diesel	7685	6	112.00	38
8210.42.152	Diesel	13798	6	137.00	84	8361.05	Diesel	8102	6	115.00	40
8210.42.154	Diesel	13798	6	137.00	84	8460.21.002	Diesel	9500	6	120.00	46
8210.42.155	Diesel	13798	6	137.00	84	8460.21.010	Diesel	9500	6	120.00	46
8210.42.161	Diesel	13798	6	137.00	84	8460.21.102	Diesel	9500	6	120.00	46
8210.42.162	Diesel	13798	6	137.00	84	8460.21.202	Diesel	9500	6	120.00	47
8210.42.165	Diesel	13798	6	137.00	84	8460.21.206	Diesel	9500	6	120.00	47
8210.42.171	Diesel	13798	6	137.00	84	8460.21.601	Diesel	9498	6	120.00	43
8210.42.172	Diesel	13798	6	137.00	84	8460.21.611	Diesel	9498	6	120.00	43
8210.42.175	Diesel	13798	6	137.00	84	8460.21B.613/8460.21B.615	Diesel	9500	6	120.00	44
8210.42.181	Diesel	13798	6	137.00	84	8460.41	Diesel	9500	6	120.00	45
8210.42.182	Diesel	13798	6	137.00	84	8460.41 M	Diesel	9500	6	120.00	50
8210.42.185	Diesel	13798	6	137.00	84	8460.41 R	Diesel	9500	6	120.00	47
8210.42.186	Diesel	13798	6	137.00	84	8460.41 S	Diesel	9500	6	120.00	50
8210.42.191	Diesel	13798	6	137.00	84	8460.41.102	Diesel	9500	6	120.00	49
8210.42.195	Diesel	13798	6	137.00	84	8460.41.124	Diesel	9500	6	120.00	46
8210.42.210	Diesel	13798	6	137.00	81	8460.41.160	Diesel	9500	6	120.00	46
8210.42.235	Diesel	13798	6	137.00	81	8460.41C	Diesel	9500	6	120.00	48
8210.42.237	Diesel	13798	6	137.00	81	8460.41C (TCA)	Diesel	9500	6	120.00	48
8210.42.269	Diesel	13798	6	137.00	81	8460.41C.320	Diesel	9500	6	120.00	48
8210.42.270	Diesel	13798	6	137.00	81	8460.41K	Diesel	9500	6	120.00	48
8210.42.271	Diesel	13798	6	137.00	81	8460.41K. TCA	Diesel	9500	6	120.00	48
8210.42.500	Diesel	13798	6	137.00	81	8460.41K.406	Diesel	9500	6	120.00	48
8210.42K	Diesel	13798	6	137.00	82	8460.41K.410	Diesel	9500	6	120.00	48
8210.42K	Diesel	13798	6	137.00	83	8460.41L (TCA)	Diesel	9500	6	120.00	48
8210.42L	Diesel	13790	6	137.00	76	8460.41L.5020	Diesel	9500	6	120.00	48
8210.42L	Diesel	13798	6	137.00	85	8460.41N	Diesel	9500	6	120.00	50
8210.42L (TCA)	Diesel	13798	6	137.00	85	BF6L 913 T	Diesel	4086	4	102.00	11
8210.42L.400	Diesel	13798	6	137.00	85	BF6L 913	Diesel	6128	6	102.00	36
8210.42M	Diesel	13798	6	137.00	85	BF6L 913 T	Diesel	6128	6	102.00	36
8210.42M (TCA)	Diesel	13798	6	137.00	85	BF6L 913/U	Diesel	6128	6	102.00	36
8220.02	Diesel	9572	6	125.00	51	BF8L 413 F	Diesel	12763	8	125.00	67
8220.02.870	Diesel	9572	6	125.00	54	BF8L 513	Diesel	12763	8	125.00	67
8220.12	Diesel	9572	6	125.00	52	CO2 D	Diesel	4397	4	108.00	12
8220.22.002	Diesel	9572	6	125.00	55	F10L 413 F	Diesel	15953	10	125.00	86
8220.22.102	Diesel	9572	6	125.00	56	F2BE 0681 A	Diesel	7790	6	115.00	39
8220.32	Diesel	9572	6	125.00	53	F2BE 0681 B	Diesel	7790	6	115.00	39
8260.02	Diesel	12880	6	145.00	71	F2BE 0681 C	Diesel	7790	6	115.00	39
8261.02.002	Diesel	12880	6	145.00	72	F2BE 0681 D	Diesel	7790	6	115.00	39
8280.02.109	Diesel	17174	8	145.00	90	F2BE 0681 F	Diesel	7790	6	115.00	39
8280.02.269	Diesel	17174	8	145.00	89	F3A3681A	Diesel	10300	6	125.00	58
8280.22.	Diesel	17174	8	145.00	91	F3A3681B	Diesel	10300	6	125.00	58
8280.22.007	Diesel	17174	8	145.00	91	F3A3681Y	Diesel	10300	6	125.00	58
8280.22.009	Diesel	17200	8	145.00	94	F3AE 0681 B	Diesel	10300	6	125.00	59
8280.22.033	Diesel	17174	8	145.00	91	F3AE 0681 D	Diesel	10300	6	125.00	59
8280.22.054	Diesel	17174	8	145.00	91	F3AE 0681 E	Diesel	10300	6	125.00	59
8280.22.154	Diesel	17174	8	145.00	91	F3B3681A	Diesel	12880	6	135.00	68
8280.22.201	Diesel	17174	8	145.00	91	F3B3681B	Diesel	12880	6	135.00	68
8280.22.205	Diesel	17174	8	145.00	92	F3B3681C	Diesel	12880	6	135.00	68
8280.42.001	Diesel	17174	8	145.00	93	F3B3681D	Diesel	12880	6	135.00	68
8280.42.050	Diesel	17174	8	145.00	93	F3B3681E	Diesel	12880	6	135.00	68
8280.42B	Diesel	17173	8	145.00	87	F3B3681G	Diesel	12880	6	135.00	68
8280.42S (TCA)	Diesel	17173	8	145.00	88	F3BE 0681 A	Diesel	12880	6	135.00	70
8280.42S.342	Diesel	17174	8	145.00	93	F3BE 0681 B	Diesel	12880	6	135.00	69
8280.42S.350	Diesel	17174	8	145.00	93	F3BE 0681 C	Diesel	12880	6	135.00	69
8280.42S.352	Diesel	17174	8	145.00	93	F3BE 0681 E	Diesel	12880	6	135.00	69
8280.42S.362	Diesel	17174	8	145.00	93	F3BE 0681 G	Diesel	12880	6	135.00	69
8340.04	Diesel	4570	4	115.00	13	F3BE0681D	Diesel	12882	6	135.00	74
8340.04.040	Diesel	4570	4	115.00	14	F3BE3681A	Diesel	12882	6	135.00	73
8340.04.200	Diesel	4570	4	115.00	14	F3BE3681B	Diesel	12880	6	135.00	68
8340.04.250	Diesel	4570	4	115.00	14	F3BE3681C	Diesel	12880	6	135.00	68
8340.04.300	Diesel	4570	4	115.00	14	F3BE3681D	Diesel	12882	6	135.00	73
8340.04.350	Diesel	4570	4	115.00	14	F3BE3681E	Diesel	12882	6	135.00	73
8340.04.362	Diesel	4570	4	115.00	14	F3BE3681F	Diesel	12882	6	135.00	73
8340.04.R.001	Diesel	4570	4	115.00	13	F3BE3681G	Diesel	12882	6	135.00	73
8340.05.200	Diesel	5401	4	115.00	18	F4L 913	Diesel	4086	4	102.00	11
8360.04	Diesel	6855	6	115.00	37	F6L 913	Diesel	6128	6	102.00	36
8360.05.200	Diesel	8102	6	115.00	41	F8L 413 F	Diesel	12763	8	125.00	66
8360.05.254	Diesel	8102	6	115.00	41	F8L 513	Diesel	13383	8	128.00	75

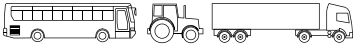
					
21			21		
9			9		
50.10	01/77→	13	380 E 31 HW	01/89→	77
50.9	01/77→	13	380 E34		44
50F.9		13	400 E 31 HT	01/89→	77
50NC.9		13	400 E34		44
55.10	01/77→	13	400 E38		44
55.9	01/77→	13	401 UM	→12/66	62
55F.9		13	401 UM 2	→12/66	62
60.10		13	405	→12/66	62
65.10		13	410		63
70.10		13	410 A		63
75.10		13	411	→12/66	62
79.10		13	414		15
80 E 15 EuroCargo		26	416		15
80 E 21		27	416 A		16
80.16 P	01/83→	22	418 418 A		60
85 E 18 EuroCargo		26	418 418 AC		60
95 E 18 EuroCargo		26	418 418 AL		60
95 E 18W		27	440		82
100 E 1 EuroCargo		27	440 E38		44
110.14	01/80→	37	470.20	01/80→	52
115.17 I Serie	01/83→	22	480 TurboCity		44
120 E 23 EuroCargo		27	490		44
120.14	01/80→	37	570.20	01/80→	52
129.14	01/80→	37	580 TurboCity		44
130 E 23 EuroCargo		27	590 E22		44
130.14	01/80→	37	643 EP	01/63→12/71	42
130.20 NC	01/75→	51	643 N	01/63→12/71	42
130.20 NR	01/75→	51	643 N1	01/63→12/71	42
130.20 NT	01/75→	51	643 T	01/63→12/71	42
135 E 22W EuroCargo		27	643 T1	01/63→12/71	42
135.17 I Serie	01/83→	22	645 N	01/58→12/69	15
140.20	01/75→	51	645 N1	01/60→12/71	16
150 E 23 EuroCargo		27	645 N2	01/60→12/71	16
150 N		52	650 E	01/58→12/69	15
150 R		52	650 N	01/58→12/69	15
150.14	01/80→	37	650 N1	01/69→12/71	16
150.20		52	650 N2	01/69→12/71	16
150.20 NC	01/75→	51	650 NA		15
150.20 NR	01/75→	51	650 NB		15
150.20 NT	01/75→	51	655 N		16
159 NT	01/70→	60	662 N	01/58→12/69	15
159.20 NC	01/78→	51	662 N1		16
160 NC	01/70→	60	662 N2		16
160 NT	01/70→	60	672 N2	01/69→12/71	16
160 R	01/70→	60	682 N1	01/55→12/66	62
170.20 NC	01/75→	51	682 N2	01/55→12/66	62
180 E 21		27	682 R N2	01/55→12/66	62
180 E 24	01/91→	38	682 T	01/55→12/66	62
180 E30		44	682 T2	01/55→12/66	62
180 E34		44	684 N	01/70→	57
190		82	684 NP	01/70→	57
190 E 24	01/91→	38	684 T	01/70→	57
190 E 31 HY	01/89→	77	684 T 9.2 Ton	01/70→	60
190 E30		44	690 N	01/55→12/71	62
190.20 H	01/75→	51	690 N4	01/70→	57
190.20 N	01/75→	51	690 T	01/55→12/71	62
190.20 NC	01/75→	51	720		82
220.32 TRU		45	5522		44
240 E38		44	Anfibio 90 PM 16	01/91→	22
260		82	A55.10		13
301	01/63→	42	A60.10		13
308	01/63→	42	E37 Eurotrakker		82
308 L		60	Astra BM 25 (6x4)		71
308 L	01/63→	42	Astra BM 30 (6x6)		71
309	01/63→	42	Astra BM 305		71
314		15	Bus 315.17	01/83→	22
331 A	01/63→	42	Bus 331A	01/71→	57
340	01/63→	42	Bus 370.20	01/75→	51
343 R	01/70→	60	Bus 370.25	01/90→	71
343 T	01/70→	60	Bus 409	01/63→	42
350	01/63→	42	Bus 420	01/63→	42
370 SE 2.27	01/91→	38	Bus 470.20	01/75→	51
380		82	Bus 470.24	01/87→	53



21

9



21

9

Bus 670.20	01/80→	52	EuroCargo 280 E 23		27
Bus 671.24	01/87→	53	EuroCargo 280 E 23 T	01/92→	27
Bus A55.10	01/77→	13	EuroCargo 320 E 27		38
Bus A60.10	01/77→	13	EuroCargo 320 E 27 T	01/92→	38
C 40		15	EuroStar LD 190 E 38 P	01/93→02/02	48
C 50		15	EuroStar LD 190 E 39 P, LD 190 E 39 FP	11/99→02/02	59
C 145 N		15	EuroStar LD 190 E 40	09/00→02/02	59
Cargo India 3.9TD		2	EuroStar LD 190 E 42, LD 190 E 42 P	01/93→02/02	76
Cerbiatto	01/62→12/69	12	EuroStar LD 190 E 42, LD 190 E 42 P	01/93→02/02	85
Daino	01/62→12/69	12	EuroStar LD 190 E 43, LD 190 E 43 P, LD 190 E 43 FP	11/99→02/02	59
Eurocargo 3.9TD		2	EuroStar LD 190 E 47	01/93→02/02	85
Eurocargo 7.7TD	01/91→	38	EuroStar LD 190 E 52	01/93→02/02	88
EuroCargo 60 E 10	01/91→08/96	6	EuroStar LD 240 E 38	01/93→02/02	48
EuroCargo 60 E 12	01/91→12/96	2	EuroStar LD 240 E 42 FS, LD 240 E 42 PS	01/93→02/02	76
EuroCargo 60 E 14	01/91→12/96	6	EuroStar LD 240 E 42 FS, LD 240 E 42 PS	01/93→02/02	85
EuroCargo 60 E 14 K	01/91→12/96	6	EuroStar LD 240 E 47 P	01/93→02/02	85
EuroCargo 65 E 10	01/91→12/96	6	EuroStar LD 240 E 52 P	01/93→02/02	88
EuroCargo 65 E 10 K	01/91→12/96	6	EuroStar LD 260 E 38 P	01/93→02/02	48
EuroCargo 65 E 12	01/91→12/00	2	EuroStar LD 260 E 39 P, LD 260 E 39 FP	11/99→02/02	59
EuroCargo 65 E 12 K	01/91→12/00	2	EuroStar LD 260 E 40	09/00→02/02	59
EuroCargo 65 E 14	01/91→12/00	6	EuroStar LD 260 E 42 P	01/93→02/02	85
EuroCargo 65 E 14 K	01/91→12/00	6	EuroStar LD 260 E 43 Y/PS, LD 260 E 43 FP	01/93→02/02	59
EuroCargo 75 E 12	01/91→12/00	2	EuroStar LD 260 E 47	01/93→02/02	85
EuroCargo 75 E 12 K	01/97→	2	EuroStar LD 260 E 48 Y/PS	01/93→02/02	69
EuroCargo 75 E 14	01/91→	10	EuroStar LD 260 E 52	01/93→02/02	88
EuroCargo 75 E 14	01/91→	6	EuroStar LD 400 E 38 TXP, LD 440 E 38 TXP	01/93→02/02	48
EuroCargo 75 E 14 K	01/97→	10	EuroStar LD 400 E 38 TXP, LD 440 E 38 TXP	01/93→02/02	50
EuroCargo 75 E 14 K	01/97→	6	EuroStar LD 400 E 42 TXP, LD 440 E 42 TXP	01/93→02/02	85
EuroCargo 75 E 15 K	01/91→09/00	27	EuroStar LD 440 E	01/01→02/02	59
EuroCargo 75 E 15, 80 E 15	01/91→09/00	27	EuroStar LD 440 E 38 T	01/93→02/02	48
EuroCargo 80 E 15	01/91→	27	EuroStar LD 440 E 38 T	01/93→02/02	50
EuroCargo 80 E 15 K	01/91→	27	EuroStar LD 440 E 38 TZ	01/93→02/02	48
EuroCargo 80 E 18	01/91→	35	EuroStar LD 440 E 38 TZ	01/93→02/02	50
EuroCargo 80 E 18 K	01/91→	35	EuroStar LD 440 E 39 T, LD 440 E 39 T/P	11/99→02/02	59
EuroCargo 80 E 21	01/91→	27	EuroStar LD 440 E 39 TX, LD 440 E 39 TX/P	11/99→	59
EuroCargo 95 E 15 W	11/93→	27	EuroStar LD 440 E 40 T	09/00→02/02	59
EuroCargo 95 E 21 W	11/93→	27	EuroStar LD 440 E 42 T/P	01/93→02/02	76
EuroCargo 100 E 15	01/91→	27	EuroStar LD 440 E 42 T/P	01/93→02/02	85
EuroCargo 100 E 15 K	01/91→	27	EuroStar LD 440 E 42 TZ	01/93→02/02	85
EuroCargo 100 E 18	01/91→	35	EuroStar LD 440 E 43 T/P	01/93→02/02	59
EuroCargo 100 E 18 K	01/91→	35	EuroStar LD 440 E 43 TX/P	11/99→02/02	59
EuroCargo 100 E 21	01/91→	27	EuroStar LD 440 E 47 T/P	01/93→02/02	85
EuroCargo 120 E 15	01/91→	27	EuroStar LD 440 E 47 TZ	01/93→02/02	85
EuroCargo 120 E 15 K	01/92→	27	EuroStar LD 440 E 48 T/P	01/01→02/02	69
EuroCargo 120 E 18	01/92→	27	EuroStar LD 440 E 52 T	01/93→02/02	88
EuroCargo 120 E 18 K	01/92→	27	EuroStar LD 440 E 52 TZ	01/93→02/02	88
EuroCargo 120 E 23	01/92→	27	Eurotech 7.7TD	01/91→	38
EuroCargo 130 E 15	01/94→	27	EuroTech MH 190 E 24, 190 E 24 /P	09/98→	39
EuroCargo 130 E 15 K	01/94→	27	EuroTech MH 190 E 27, 190 E 27 /P	09/98→	39
EuroCargo 130 E 18	01/92→	27	EuroTech MH 190 E 31, 190 E 31 /P	09/98→	39
EuroCargo 130 E 18 K	01/92→	27	EuroTech MH 190 E 35, 190 E 35 /P, 190 E 35 /FP	09/98→	39
EuroCargo 130 E 23	01/92→	27	EuroTech MH 260 E 24 Y/P, 260 E 24 Y/PS, 260 E 24 Y/PT	11/99→	39
EuroCargo 135 E 18 W	01/97→	27	EuroTech MH 260 E 27 Y/P, 260 E 27 Y/PS, 260 E 27 RV/PS,	11/99→	39
EuroCargo 135 E 18 WR	01/93→12/96	27	260 E 27 RV/PT		
EuroCargo 135 E 23 W	01/97→	27	EuroTech MH 260 E 31 Y/P, 260 E 31 Y/PS, 260 E 31 Y/PT	11/99→	39
EuroCargo 135 E 23 WR	01/93→12/96	27	EuroTech MH 260 E 35 Y/P, 260 E 35 Y/PT, 260 E 35 Y/TN	11/99→	39
EuroCargo 150 E 15	01/92→12/96	27	EuroTech MH 400 E 31 TP, 440 E 31 T, 440 E 31 TP	09/98→	39
EuroCargo 150 E 15 K	01/92→12/96	27	EuroTech MH 400 E 35 TP, 440 E 35 T, 440 E 35 T/P, 440 E 35 T/FP	09/98→	39
EuroCargo 150 E 18	01/92→	27	EuroTech MH 440 E 35 TX/P	02/00→	39
EuroCargo 150 E 18	01/92→	35	EuroTech MH MH 190 E 24 K	09/98→	39
EuroCargo 150 E 18 K	01/92→	27	EuroTech MH MH 190 E 27 K	09/98→	39
EuroCargo 150 E 18 K	01/92→	35	EuroTech MH MH 190 E 31 K	09/98→	39
EuroCargo 150 E 23	01/92→	27	EuroTech MP 190 E 39, 190 E 39 /P, 190 E39 /FP	11/99→	59
EuroCargo 150 E 27, 150 E 27 R	01/92→	38	EuroTech MP 190 E 40 /P	01/01→	59
EuroCargo 170 E 18 K, 180 E 18 K	01/94→	27	EuroTech MP 190 E 42, 190 E 42 /P	01/93→	85
EuroCargo 170 E 18, 180 E 18	01/94→	27	EuroTech MP 190 E 43, 190 E 43 /P	01/01→	59
EuroCargo 170 E 23 K, 180 E 23 K	01/94→	27	EuroTech MP 260 E 39 Y, 260 E 39 Y/P, 260 E 39 Y/FP, 260 E 39 Y/FS	11/99→	59
EuroCargo 170 E 23, 180 E 23	01/94→	27	EuroTech MP 260 E 40 Y/P	01/01→	59
EuroCargo 170 E 27, 180 E 27	01/94→	38	EuroTech MP 260 E 43 Y, 260 E 43 Y/P	11/99→	59
EuroCargo 180 E 21 T	01/91→	27	EuroTech MP 400 E 38 T, 440 E 38 T, 440 E 38 T /P	01/92→	48
EuroCargo 260 E 23		27	EuroTech MP 400 E 38 T, 440 E 38 T, 440 E 38 T /P	01/92→	50
EuroCargo 260 E 23 T	01/92→	27	EuroTech MP 400 E 42 T, 440 E 42 T, 440 E 42 T/P	01/92→	76
EuroCargo 260 E 27 KE		38	EuroTech MP 400 E 42 T, 440 E 42 T, 440 E 42 T/P	01/92→	85



21

9

EuroTech MP 440 E 39 T, 440 E 39 T/P, 440 E 39 T/FP-CT	11/99→	59
EuroTech MP 440 E 40 T	09/00→	59
EuroTech MP 440 E 40 TX/P	01/01→	59
EuroTech MP 440 E 43 T, 440 E 43 T/P	11/99→	59
EuroTech MP 440 E 43 TX/P	11/99→	59
EuroTech MP 4300	01/02→	59
EuroTech MP MP 180 E 34	01/92→12/93	48
EuroTech MP MP 180 E 38	01/92→12/93	48
EuroTech MP MP 180 E 42	01/92→12/93	85
EuroTech MP MP 190 E 34	01/93→	48
EuroTech MP MP 190 E 38	01/93→	48
EuroTech MP MP 240 E 30 PS	01/97→	48
EuroTech MP MP 240 E 34	09/95→12/96	48
EuroTech MP MP 240 E 38	01/92→	48
EuroTech MP MP 240 E 42	01/92→	85
EuroTech MP MP 260 E 38 P	01/94→	50
EuroTech MP MP 260 E 42	01/94→	85
EuroTech MP MP 400 E 34 T, MP 440 E 34 T	01/92→	48
EuroTech MP MP 400 E 38 TXP	11/93→12/96	48
EuroTech MP MP 400 E 38 TXP	11/93→12/96	50
EuroTech MP MP 440 E 38 TZ	01/93→	48
EuroTech MP MP 440 E 39 TX/P	11/99→	59
EuroTech MP MP 440 E 42 TZ	01/93→	85
EuroTech MT MT 180 E 24	01/92→12/96	38
EuroTech MT MT 180 E 24 K	01/93→12/96	38
EuroTech MT MT 180 E 27	01/92→12/96	38
EuroTech MT MT 180 E 27 K	01/92→12/96	38
EuroTech MT MT 180 E 30 R	01/92→12/96	48
EuroTech MT MT 180 E 34 R	01/92→12/93	48
EuroTech MT MT 190 E 24	01/97→08/98	38
EuroTech MT MT 190 E 24 K	01/97→08/98	38
EuroTech MT MT 190 E 27	01/97→08/98	38
EuroTech MT MT 190 E 27 K	01/97→08/98	38
EuroTech MT MT 190 E 30	01/97→08/98	48
EuroTech MT MT 190 E 30 K	01/97→08/98	48
EuroTech MT MT 400 E 30 T	01/92→08/98	48
EuroTech MT MT 400 E 34 T	01/92→08/98	48
EuroTrakker MP 180 E 24 W Cursor	09/99→11/04	39
EuroTrakker MP 190	01/01→11/04	69
EuroTrakker MP 190 E 24 H Cursor	09/99→11/04	39
EuroTrakker MP 190 E 30 H	01/93→11/04	48
EuroTrakker MP 190 E 30 W	01/93→11/04	48
EuroTrakker MP 190 E 31 H Cursor	09/99→11/04	39
EuroTrakker MP 190 E 31 W Cursor	09/99→11/04	39
EuroTrakker MP 190 E 34 H	01/93→11/04	48
EuroTrakker MP 190 E 34 W	01/93→11/04	48
EuroTrakker MP 190 E 34 W	11/99→11/04	48
EuroTrakker MP 190 E 35 H Cursor	09/99→11/04	39
EuroTrakker MP 190 E 35 W Cursor	09/99→11/04	39
EuroTrakker MP 190 E 37 H	01/93→11/04	83
EuroTrakker MP 190 E 37 H	01/00→11/04	83
EuroTrakker MP 190 E 37 W	01/93→11/04	83
EuroTrakker MP 190 E 37 W	11/99→11/04	83
EuroTrakker MP 190 E 38 W	01/01→11/04	69
EuroTrakker MP 190 E 42 H	01/93→11/04	85
EuroTrakker MP 190 E 42 H	11/99→11/04	76
EuroTrakker MP 190 E 42 W	01/93→11/04	76
EuroTrakker MP 190 E 42 W	01/93→11/04	85
EuroTrakker MP 190 E 44 W Cursor	09/00→11/04	69
EuroTrakker MP 190 E 47 W	11/99→11/04	85
EuroTrakker MP 190 E 55 W Cursor	09/00→11/04	69
EuroTrakker MP 260 E 27 H Cursor	11/99→11/04	39
EuroTrakker MP 260 E 30 H	01/93→11/04	48
EuroTrakker MP 260 E 30 W	11/99→11/04	48
EuroTrakker MP 260 E 31 H Cursor	09/99→11/04	39
EuroTrakker MP 260 E 31 HB Cursor	11/99→11/04	39
EuroTrakker MP 260 E 34 H	01/93→11/04	48
EuroTrakker MP 260 E 34 H	11/99→11/04	48
EuroTrakker MP 260 E 34 W	01/93→11/04	48
EuroTrakker MP 260 E 34 W	11/99→11/04	48
EuroTrakker MP 260 E 35 H Cursor	01/00→11/04	39
EuroTrakker MP 260 E 35 W Cursor	09/99→11/04	39
EuroTrakker MP 260 E 37 H	01/93→11/04	83



21

9

EuroTrakker MP 260 E 37 W	01/93→11/04	83
EuroTrakker MP 260 E 37 W	11/99→11/04	83
EuroTrakker MP 260 E 38 H Cursor	01/01→11/04	69
EuroTrakker MP 260 E 38 W Cursor	01/01→11/04	69
EuroTrakker MP 260 E 42 H	01/93→11/04	85
EuroTrakker MP 260 E 42 H	11/99→11/04	76
EuroTrakker MP 260 E 42 W	01/93→11/04	76
EuroTrakker MP 260 E 42 W	01/93→11/04	85
EuroTrakker MP 260 E 44 H Cursor	01/00→11/04	69
EuroTrakker MP 260 E 44 W Cursor	01/01→11/04	69
EuroTrakker MP 260 E 47 H	11/99→11/04	85
EuroTrakker MP 260 E 47 W	11/99→11/04	85
EuroTrakker MP 260 E35 H Cursor	01/00→11/04	39
EuroTrakker MP 340 E 34 H	01/93→11/04	48
EuroTrakker MP 340 E 34 H	11/99→11/04	48
EuroTrakker MP 340 E 35 H Cursor	09/99→11/04	39
EuroTrakker MP 340 E 35 HB Cursor	01/01→11/04	39
EuroTrakker MP 340 E 37 H	01/93→11/04	83
EuroTrakker MP 340 E 37 H	11/99→11/04	83
EuroTrakker MP 340 E 38 H Cursor	01/01→11/04	69
EuroTrakker MP 340 E 38 HB Cursor	01/01→11/04	69
EuroTrakker MP 340 E 42 H	01/93→11/04	85
EuroTrakker MP 340 E 42 H	11/99→11/04	76
EuroTrakker MP 340 E 44 Cursor	01/01→11/04	69
EuroTrakker MP 340 E 44 H Cursor	01/01→11/04	69
EuroTrakker MP 340 E 44 HB Cursor	01/01→11/04	69
EuroTrakker MP 380 E 34 H	01/93→11/04	48
EuroTrakker MP 380 E 34 H	11/99→11/04	48
EuroTrakker MP 380 E 34 W	11/99→11/04	48
EuroTrakker MP 380 E 35 H Cursor	01/00→11/04	39
EuroTrakker MP 380 E 35 W Cursor	01/00→11/04	39
EuroTrakker MP 380 E 37 H	01/93→11/04	83
EuroTrakker MP 380 E 37 H	11/99→11/04	83
EuroTrakker MP 380 E 37 W	01/93→11/04	83
EuroTrakker MP 380 E 37 W	11/99→11/04	83
EuroTrakker MP 380 E 38 H Cursor	01/01→11/04	69
EuroTrakker MP 380 E 38 HB Cursor	01/01→11/04	69
EuroTrakker MP 380 E 38 W Cursor	01/01→11/04	69
EuroTrakker MP 380 E 42 H	01/93→11/04	76
EuroTrakker MP 380 E 42 H	01/93→11/04	85
EuroTrakker MP 380 E 42 W	01/93→11/04	85
EuroTrakker MP 380 E 42 W	11/99→11/04	76
EuroTrakker MP 380 E 44 H Cursor	01/01→11/04	69
EuroTrakker MP 380 E 44 HB Cursor	01/01→11/04	69
EuroTrakker MP 380 E 44 W	01/01→11/04	69
EuroTrakker MP 380 E 44 W Cursor	01/01→11/04	69
EuroTrakker MP 380 E 47 H	11/99→11/04	85
EuroTrakker MP 380 E 47 W	11/99→11/04	85
EuroTrakker MP 400 E 34 HT	01/93→11/04	48
EuroTrakker MP 400 E 35 HT Cursor	01/00→11/04	39
EuroTrakker MP 400 E 37 HT	01/93→11/04	83
EuroTrakker MP 400 E 37 WT	01/93→11/04	83
EuroTrakker MP 400 E 42 HT	01/93→11/04	76
EuroTrakker MP 400 E 42 HT	01/93→11/04	85
EuroTrakker MP 400 E 42 WT	01/93→11/04	76
EuroTrakker MP 400 E 42 WT	01/93→11/04	85
EuroTrakker MP 410 E 35 H Cursor	01/00→11/04	39
EuroTrakker MP 410 E 37 H	01/93→11/04	83
EuroTrakker MP 410 E 37 H	11/99→11/04	83
EuroTrakker MP 410 E 38 H Cursor	01/01→11/04	69
EuroTrakker MP 410 E 38 HB Cursor	01/01→11/04	69
EuroTrakker MP 410 E 42 H	01/93→11/04	85
EuroTrakker MP 410 E 42 H	11/99→11/04	76
EuroTrakker MP 410 E 42 W	01/93→11/04	76
EuroTrakker MP 410 E 42 W	01/93→11/04	85
EuroTrakker MP 410 E 44 H Cursor	01/01→11/04	69
EuroTrakker MP 410 E 44 HB Cursor	01/01→11/04	69
EuroTrakker MP 410 E 47 H	11/99→11/04	85
EuroTrakker MP 410 E 47 W	11/99→11/04	85
EuroTrakker MP 440 E 34 HT	01/93→11/04	48
EuroTrakker MP 440 E 37 HT	01/93→11/04	83
EuroTrakker MP 440 E 38 HT Cursor	01/01→11/04	69



21

9



21

9

EuroTrakker MP 440 E 42 HT	01/93→11/04	76	P/PA 170-25 AHW,180-25 AHW	01/91→12/93	75
EuroTrakker MP 440 E 42 HT	01/93→11/04	85	P/PA 170-34 AH	04/89→12/93	67
EuroTrakker MP 440 E 44 HT Cursor	01/01→11/04	69	P/PA 170-34 AH,180-34 AH	01/91→12/93	67
EuroTrakker MP 440 E 47 HT	11/99→11/04	85	P/PA 170-34 AHW	04/89→12/90	67
EuroTrakker MP 720 E 37 HT	01/93→11/04	83	P/PA 170-34 AHW,180-34 AHW	01/91→12/93	67
EuroTrakker MP 720 E 37 WT	01/93→11/04	83	P/PA 190-25 AH	07/83→06/86	66
EuroTrakker MP 720 E 38 HT Cursor	01/01→11/04	69	P/PA 190-25 AHW	07/83→06/86	66
EuroTrakker MP 720 E 42 HT	01/93→11/04	76	P/PA 190-30 H	04/87→12/92	79
EuroTrakker MP 720 E 42 HT	01/93→11/04	85	P/PA 190-30 HT	01/89→12/92	79
EuroTrakker MP 720 E 42 WT	01/93→11/04	76	P/PA 190-30 HW	04/87→12/92	79
EuroTrakker MP 720 E 42 WT	01/93→11/04	85	P/PA 190-32 AH	01/83→12/85	86
EuroTrakker MP 720 E 44 HT Cursor	01/01→11/04	69	P/PA 190-32 AHW	01/83→12/85	86
EuroTrakker MP 720 E 47 HT	01/93→11/04	85	P/PA 260-25 AH	03/84→06/86	66
EuroTrakker MP 720 E 48 HT Cursor	01/01→11/04	69	P/PA 260-25 AH	04/89→12/92	75
EuroTrakker MPÜ 410 E 38 H Cursor	01/01→11/04	69	P/PA 260-25 AHB	12/79→06/86	66
F 10	01/77→	13	P/PA 260-25 AHW	03/84→06/86	66
I-Effeuno		53	P/PA 260-30 AH	06/86→05/90	67
Inbus AS 250		53	P/PA 260-30 AHT	06/86→05/90	67
Inbus I 120		53	P/PA 260-30 AHW	06/86→05/90	67
Industrial		40	P/PA 260-32 AH	01/83→12/85	86
L 626 MCS		38	P/PA 260-32 AHT	01/83→12/85	86
Leoncino 30	01/62→12/69	12	P/PA 260-32 AHW	01/83→12/85	86
Leoncino 35	01/62→12/69	12	P/PA 260-34 AH	04/89→12/92	67
M 115-17	09/83→12/85	25	P/PA 260-34 AHT	04/89→12/92	67
M 115-17	01/86→12/91	34	P/PA 260-34 AHW	01/91→12/92	67
M 115-17 H	01/86→12/91	34	P/PA 300-30 AH	04/87→05/89	67
M 135-17	09/83→12/85	25	P/PA 300-30 AHB	04/87→05/89	67
M 135-17	01/86→12/91	34	P/PA 330-30 H	06/84→12/92	79
M 135-17 H	01/86→12/92	34	P/PA 330-30 HT	01/88→12/92	79
M 135-17 T	09/83→12/85	25	P/PA 330-30 HW	01/88→12/92	79
M 135-17 T	01/86→12/91	34	P/PA 330-36 H	01/89→12/92	81
M 145-17	02/86→12/91	34	P/PA 330-36 HT	01/89→12/92	81
M 159-17	07/82→09/86	41	P/PA 330-36 HW	01/89→12/92	81
M 165-24 R	06/82→09/86	55	P/PA 340-34 AH	03/89→12/92	67
M 165-24 R	06/82→09/86	56	P/PA-Bonneted Trucks 120-13 ANW	01/83→09/90	36
M 165-24 T	06/82→09/86	55	P/PA-Bonneted Trucks 120-16 ANW,120-17 ANW	01/83→11/89	36
M 165-24 T	06/82→09/86	56	P/PA-Bonneted Trucks 150-16 AN	01/83→12/91	36
M 175-17	09/86→12/92	34	P/PA-Bonneted Trucks 150-16 ANW	01/83→12/91	36
M 175-24	09/86→11/92	46	P/PA-Bonneted Trucks 160-17 AN	07/89→12/93	36
M 175-24 T	09/86→11/92	46	P/PA-Bonneted Trucks 160-17 ANW	07/89→12/93	36
MK 75-9 A	01/83→05/89	11	P/PA-Bonneted Trucks 160-23 ANW	04/84→05/89	66
MK 75-9 H	01/83→08/85	11	P/PA-Bonneted Trucks 170-23 ANW	04/88→12/93	75
MK 80-13 A	01/83→12/91	36	P/PA-Bonneted Trucks 190-25 AN	07/83→09/90	66
MK 80-13 AH	01/83→12/91	36	P/PA-Bonneted Trucks 190-25 ANT	07/83→12/87	66
MK 80-13 AT	01/83→12/91	36	P/PA-Bonneted Trucks 190-25 ANW	07/83→09/90	66
MK 80-13 AW	01/83→12/91	36	P/PA-Bonneted Trucks 190-30 N	04/87→12/93	79
MK 80-16 A	01/83→12/91	36	P/PA-Bonneted Trucks 190-30 NT	04/87→12/93	79
MK 80-16 AW	01/86→12/89	36	P/PA-Bonneted Trucks 260-25 AN	07/83→06/86	66
MK 80-9 A	01/83→02/86	11	P/PA-Bonneted Trucks 260-25 ANW	07/83→06/86	66
MK 80-9 AH	01/83→02/86	11	P/PA-Bonneted Trucks 330-30 AN	05/86→09/90	67
MK 90-13 A	01/83→12/91	36	P/PA-Bonneted Trucks 330-30 ANW	05/86→09/90	67
MK 90-13 AH	01/83→12/91	36	P/PA-Bonneted Trucks 330-30 N	10/87→12/92	79
MK 110-13 A	01/83→12/91	36	P/PA-Bonneted Trucks 330-30 NW	10/87→12/92	79
MK 110-13 AH	01/83→12/85	36	S Effeuno		52
MK 110-16 A	01/83→12/91	36	S Inbus 210		61
MK 110-16 AH	01/83→12/91	36	Stralis AD 190S27, AT 190S27	06/03→	39
MK 110-16 AT	01/83→12/85	36	Stralis AD 190S30, AD 190S31, AT 190S31	06/03→	39
MK 130-13 A	01/83→12/91	36	Stralis AD 190S35	04/04→	39
MK 130-13 AH	01/83→12/91	36	Stralis AD 190S35, AT 190S35, AD 190S36, AT 190S36	06/03→	39
MK 130-16 A	01/83→12/91	36	Stralis AD 190S40, AT 190S40	03/03→	59
MK 130-16 AH	01/83→12/91	36	Stralis AD 190S42, AT 190S42, AS 190S42	07/06→	58
P/PA 159-17 H	07/82→09/86	41	Stralis AD 190S43, AT 190S43	06/03→	59
P/PA 160-23 AH	04/84→05/89	66	Stralis AD 190S45, AT 190S45	12/06→	58
P/PA 160-23 AHW	04/84→05/89	66	Stralis AD 260S27, AT 260S27	04/04→	39
P/PA 160-30 AH	06/86→05/89	67	Stralis AD 260S31, AT 260S31	06/03→	39
P/PA 160-30 AHW	06/86→05/89	67	Stralis AD 260S35	04/04→	39
P/PA 170-23 AH	04/88→12/90	75	Stralis AD 260S35, AT 260S35, AD 260S36, AT 260S36	06/03→	39
P/PA 170-23 AH,180-23 AH	01/91→12/93	75	Stralis AD 260S40, AT 260S40	06/03→	59
P/PA 170-23 AHW	04/88→12/90	75	Stralis AD 260S42, AT 260S42	12/06→	58
P/PA 170-23 AHW,180-23 AHW	01/91→12/93	75	Stralis AD 260S42, AT 260S42, AS 260S42	05/07→	58
P/PA 170-25 AH	03/89→12/90	75	Stralis AD 260S43, AT 260S43	06/03→	59
P/PA 170-25 AH,180-25 AH	01/91→12/93	75	Stralis AD 260S45, AT 260S45	12/06→	58
P/PA 170-25 AHW	03/89→12/90	75	Stralis AD 260S45, AT 260S45, AS 260S45	05/07→	58



21

9

Stralis AD 440S31, AT 440S31	06/03→	39
Stralis AD 440S35, AT 440S35, AD 440S36, AT 440S36	06/03→	39
Stralis AD 440S40, AT 440S40	03/03→	59
Stralis AD 440S42, AT 440S42	04/06→	58
Stralis AD 440S43, AT 440S43	06/03→	59
Stralis AD 440S45, AT 440S45	12/06→	58
Stralis AS 190S40	02/02→	59
Stralis AS 190S43	02/02→	59
Stralis AS 190S45	12/06→	58
Stralis AS 190S48	02/02→	69
Stralis AS 190S50	12/06→	68
Stralis AS 260S40	02/02→	59
Stralis AS 260S43	02/02→	59
Stralis AS 260S48	02/02→	69
Stralis AS 260S50	07/06→	68
Stralis AS 260S54	02/02→	70
Stralis AS 260S56	07/06→	68
Stralis AS 440S40	02/02→	59
Stralis AS 440S42	05/06→	58
Stralis AS 440S42, AT 440S42	12/06→	58
Stralis AS 440S43	02/02→	59
Stralis AS 440S45	12/06→	58
Stralis AS 440S45, AT 440S45	12/06→	58
Stralis AS 440S48	02/02→	69
Stralis AS 440S50	07/06→	68
Stralis AS 440S50, AT 440S50	12/06→	68
Stralis AS 440S54	02/02→	70
Stralis AS 440S54, ES 440S54	02/02→	70
Stralis AS 440S56	05/06→	68
Stralis AS 440S56, AT 440S56	12/06→	68
Stralis AT 440S42	07/06→	58
Stralis AT 440S43	06/03→	59
Stralis AT 440S45	07/06→	58
Stralis ES 440S48	10/04→	69
Stralis ES 440S54	10/04→	70
Tigrotto 48	01/62→12/69	12
Trakker AD 180T27 W, AT 180T27 W	06/05→	39
Trakker AD 190T27, AT 190T27	06/05→	39
Trakker AD 190T31 W, AT 190T31 W	10/04→	39
Trakker AD 190T31, AT 190T31	10/04→	39
Trakker AD 190T35 W, AD 190T36 W, AT 190T35 W, AT 190T36 W	10/04→	39
Trakker AD 190T35 W, AT 190T35 W, AD 190T36 W, AT 190T36 W	01/05→	39
Trakker AD 190T35, AD 190T36, AT 190T35, AT 190T36	10/04→	39
Trakker AD 190T35, AT 190T35, AD 190T36, AT 190T36	06/05→	39
Trakker AD 190T38 W, AT 190T38 W	10/04→	69
Trakker AD 190T38, AT 190T38	10/04→	69
Trakker AD 190T41 W, AT 190T41 W	03/06→	73
Trakker AD 190T41, AT 190T41	03/06→	73
Trakker AD 190T44 W, AD 190T45 W, AT 190T44 W, AD 190T45 W	10/04→	68
Trakker AD 190T44 W, AD 190T45 W, AT 190T44 W, AD 190T45 W	10/04→	69
Trakker AD 190T44 W, AT 190T44 W, AD 190T45 W, AT 190T45 W	06/05→	68
Trakker AD 190T44, AD 190T45, AT 190T44, AT 190T45	10/04→	68
Trakker AD 190T44, AD 190T45, AT 190T44, AT 190T45	10/04→	69
Trakker AD 190T44, AT 190T44, AD 190T45, AT 190T45	06/05→	68
Trakker AD 260T31 B	06/05→	39
Trakker AD 260T31, AT 260T31	10/04→	39
Trakker AD 260T35 B	06/05→	39
Trakker AD 260T35 W, AT 260T35 W	06/05→	39
Trakker AD 260T35, 260T36, 380T36, AT 260T35, 260T36, 380T36	10/04→	39
Trakker AD 260T35, AT 260T35	10/04→	39
Trakker AD 260T38, AT 260T38	10/04→	69
Trakker AD 260T38 B	06/05→	69
Trakker AD 260T38 W, AT 260T38 W	06/05→	69
Trakker AD 260T38, AD 260T38 /P, AT 260T38	06/05→	69
Trakker AD 260T41 W, AD 380T41 W, AT 260T41 W, AT 380T41 W	03/06→	73
Trakker AD 260T41, AD 380T41, AT 260T41, AT 380T41	03/06→	73
Trakker AD 260T44 W, AT 260T44 W	06/05→	69
Trakker AD 260T44, AD 260T44 /P, AT 260T44	06/05→	69
Trakker AD 260T45 W, AD 380T45 W, AT 260T45 W, AT 380T45 W	03/06→	68
Trakker AD 260T45, AD 380T45, AT 260T45, AT 380T45	03/06→	68
Trakker AD 260T48, AT 260T48	06/05→	69
Trakker AD 260T50, AD 380T50, AT 260T50, AT 380T50	03/06→	68
Trakker AD 340T35 B, AT 340T35 B	06/05→	39



21

9

Trakker AD 340T35, AT 340T35	06/05→	39
Trakker AD 340T38 B, AT 340T38 B	06/05→	69
Trakker AD 340T41 B	06/06→	68
Trakker AD 340T41, AT 340T41	03/06→	73
Trakker AD 340T41, AT 340T41	06/06→	68
Trakker AD 340T44 B, AT 340T44 B	06/05→	69
Trakker AD 340T44, AT 340T44	06/05→	69
Trakker AD 340T45 B	06/06→	68
Trakker AD 340T45, AD 340T45 /P, AT 340T45, AT 340T45 /P	06/06→	68
Trakker AD 340T45, AT 340T45	03/06→	68
Trakker AD 340T50, AT 340T50	03/06→	68
Trakker AD 380T35	01/05→	39
Trakker AD 380T38 B	06/05→	69
Trakker AD 380T38 W, AT 380T38 W	06/05→	69
Trakker AD 380T38, AT 380T38	01/05→	69
Trakker AD 380T41 W, AT 380T41 W	09/06→	68
Trakker AD 380T41, AT 380T41	09/06→	68
Trakker AD 380T44 B	06/05→	69
Trakker AD 380T44 W, AT 380T44 W	06/05→	69
Trakker AD 380T44, AT 380T44	06/05→	69
Trakker AD 380T45 W, AT 380T45 W	09/06→	68
Trakker AD 380T48, AD 380T48	06/05→	69
Trakker AD 380T50	03/07→	68
Trakker AD 400T35 T, AT 400T35 T	06/05→	39
Trakker AD 400T38 T, AT 400T38 T	06/05→	69
Trakker AD 400T38 WT, AT 400T38 WT	06/05→	69
Trakker AD 400T41 T, AT 400T41 T	03/06→	73
Trakker AD 400T41 WT, AT 400T41 WT	03/06→	73
Trakker AD 400T44 T, AT 400T44 T	06/05→	69
Trakker AD 400T44 WT, AT 400T44 WT	06/05→	69
Trakker AD 400T45 T, AT 400T45 T	03/06→	68
Trakker AD 400T45 WT, AT 400T45 WT	03/06→	68
Trakker AD 400T50 T, AT 400T50 T	03/06→	68
Trakker AD 410T35	02/05→	39
Trakker AD 410T38	02/05→	69
Trakker AD 410T38 B, AT 410T38 B	06/05→	69
Trakker AD 410T38 H	04/05→	69
Trakker AD 410T41, AT 410T41	03/06→	73
Trakker AD 410T41, AT 410T41	06/06→	68
Trakker AD 410T44 B, AT 410T44 B	06/05→	69
Trakker AD 410T44 W, AT 410T44 W	06/05→	69
Trakker AD 410T44, AT 410T44	02/05→	69
Trakker AD 410T45 W	03/06→	68
Trakker AD 410T45 W	07/07→	68
Trakker AD 410T45, AT 410T45	03/06→	68
Trakker AD 410T45, AT 410T45	06/06→	68
Trakker AD 410T48 B, AT 410T48 B	06/05→	69
Trakker AD 410T48, AT 410T48	02/05→	69
Trakker AD 410T50, AT 410T50	03/06→	68
Trakker AD 410T50, AT 410T50	06/06→	69
Trakker AD 440T38 T, AT 440T38 T	04/05→	69
Trakker AD 440T41 T, AT 440T41 T	03/06→	73
Trakker AD 440T44 B	06/05→	69
Trakker AD 440T44 T, AT 440T44 T	06/05→	69
Trakker AD 440T45 T, AT 440T45 T	03/06→	68
Trakker AD 440T45 T, AT 440T45 T	03/06→	68
Trakker AD 440T50 T, AT 440T50 T	03/06→	68
Trakker AD 720T38 T, AT 720T38 T	06/05→	69
Trakker AD 720T38 WT, AT 720T38 WT	06/05→	69
Trakker AD 720T41 T, AT 720T41 T	03/06→	73
Trakker AD 720T41 WT, AT 720T41 WT	03/06→	73
Trakker AD 720T44 T, AT 720T44 T	06/05→	69
Trakker AD 720T44 WT, AT 720T44 WT	06/05→	69
Trakker AD 720T45 T, AT 720T45 T	03/06→	68
Trakker AD 720T45 WT, AT 720T45 WT	03/06→	68
Trakker AD 720T48 T, AT 720T48 T	06/05→	69
Trakker AD 720T50 T, AT 720T50 T, AT 720T50 TP	03/06→	68
Trakker AT 340T38	03/05→	69
Trakker AT 340T38 W	09/05→	69
Trakker AT 410T54 T	01/05→	70
TurboStar 190-33	07/84→05/87	79
TurboStar 190-33 P	01/86→12/87	79
TurboStar 190-33 T	07/84→05/87	79
TurboStar 190-36	07/87→06/90	80



21

9



21

9

TurboStar 190-36	07/90→12/93	84
TurboStar 190-36 P	07/87→06/90	80
TurboStar 190-36 P	07/90→12/93	84
TurboStar 190-36 T	07/87→06/90	80
TurboStar 190-36 T	07/90→12/93	84
TurboStar 190-42	07/84→12/90	91
TurboStar 190-42	07/84→12/90	92
TurboStar 190-42 T	07/84→12/90	91
TurboStar 190-42 T	07/84→12/90	92
TurboStar 190-48	03/89→12/93	93
TurboStar 190-48 T	03/89→12/93	93
TurboTech 190-26	01/90→12/92	46
TurboTech 190-26 T	01/90→12/92	46
TurboTech 190-32	01/90→12/92	49
TurboTech 190-32 T	01/90→12/92	49
TurboTech 190-36	01/90→12/92	84
TurboTech 190-36 T	01/90→12/92	84
TurboTech 220-36 PT	01/90→12/92	84
TurboTech 240-36 P	01/90→12/92	84
U Inbus 210		61
U Inbus 210 FT		51
U Inbus 210.80		52
U-Effeuno		52
U-Effeuno Turbo		53
Zeta 50-10	01/79→12/86	14
Zeta 50-10 H	01/79→12/86	14
Zeta 50-10 V	01/79→12/86	14
Zeta 50-8	01/83→12/86	1
Zeta 50-8 H	01/83→12/86	1
Zeta 50-8 V	01/83→12/86	1
Zeta 50-9	01/87→03/91	3
Zeta 50-9 H	01/87→03/91	3
Zeta 50-9 V	01/87→03/91	3
Zeta 60-10	11/79→12/86	14
Zeta 60-10 H	11/79→12/86	14
Zeta 60-10 V	11/79→12/86	14
Zeta 60-11	01/87→03/91	5
Zeta 60-11 V	01/87→03/91	5
Zeta 60-8	11/79→12/83	1
Zeta 65-10	11/79→01/87	14
Zeta 65-10 H	11/79→01/87	14
Zeta 65-10 V	11/79→01/87	14
Zeta 65-12	01/87→03/91	8
Zeta 65-12 H	01/87→03/91	8
Zeta 65-12 V	01/87→03/91	8
Zeta 65-9	01/87→03/91	3
Zeta 79-10	01/83→01/87	14
Zeta 79-10 H	01/83→01/87	14
Zeta 79-10 V	01/83→01/87	14
Zeta 79-12	01/87→03/91	8
Zeta 79-12	01/87→03/91	9
Zeta 79-12 H	01/87→03/91	8
Zeta 79-12 H	01/87→03/91	9
Zeta 79-12 V	01/87→03/91	8
Zeta 79-12 V	01/87→03/91	9
Zeta 79-13	11/79→12/83	24
Zeta 79-14	01/83→11/85	24
Zeta 79-14	12/85→03/91	29
Zeta 79-14 H	01/83→11/85	24
Zeta 79-14 H	12/85→03/91	29
Zeta 79-14 V	01/83→11/85	24
Zeta 79-14 V	12/85→03/91	29
Zeta 95-14	07/83→03/91	24
Zeta 95-14 H	07/83→03/91	24
Zeta 109-14	06/83→12/85	24
Zeta 109-14	11/85→03/91	29
Zeta 109-14 H	06/83→12/85	24
Zeta 109-14 H	11/85→03/91	29
Zeta A 60-10	11/79→06/88	14
Zeta A 60-9	09/88→12/92	3
Zeta A 70-12	01/83→01/85	18
Zeta A 70-14	05/88→12/92	29
Zeta A 70-14	05/88→12/92	33



cc



kW/PS

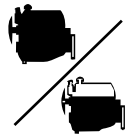

1	8040.04.200	3666	4	103.00		63/86	BV520 (Fibre), 1.35mm BS340 (Fibre), 1.58mm	DH147 ▲○ [7]	GH147 ▲○
2	8040.45.4380/ 8040.45X.4180 8040.25.4990 8040.25X.4000 8040.45.5200 8040.45D.5100	3908 3908 3908 3908	4 4 4 4	104.00 104.00 104.00 104.00	Turbo Intercooled Turbo Intercooled Turbo Euro 2/Turbo Intercooled Euro 2/Turbo Intercooled	85/115 85/116 100/136 100-85/ 136-116	BV520 (Fibre), 1.35mm BS340 (Fibre), 1.58mm	DV520 ▲○ [7]	GV520 ▲○
3	8040.05.200/8040.05.203/ 8040.05.230/8040.05.233/ 8040.05.235	3908	4	104.00		65/88	BV520 (Fibre), 1.35mm BS340 (Fibre), 1.58mm	DH146 ▲○ [7]	GH146 ▲○
4	8040.05.232	3908	4	104.00		65/88	BV520 (Fibre), 1.35mm BS340 (Fibre), 1.58mm	DH146 ▲○ [7]	GH146 ▲○
5	8040.25.230 R	3908	4	104.00	Turbo	74/100	BV520 (Fibre), 1.35mm BS340 (Fibre), 1.58mm	DH145 ▲ DH146 ▲○ [7]	GH145 ▲○
6	8040.25 B.4200 8040.25B.4220 8040.45.4000	3908 3908 3908	4 4 4	104.00 104.00 104.00	Turbo Turbo/Straight Turbo Intercooled	75/102 75/102 100/136	BV520 (Fibre), 1.35mm BS340 (Fibre), 1.58mm	DV520 ▲○ [7]	GV520 ▲○
7	8040.05.4990	3908	4	104.00	Turbo	80/109	BV520 (Fibre), 1.35mm BS340 (Fibre), 1.58mm	DV520 ▲○ [7]	GV520 ▲○
8	8040.25.200	3908	4	104.00	Turbo	85/116	BV520 (Fibre), 1.35mm BS340 (Fibre), 1.58mm	DH145 ▲	GH145 ▲○
9	8040.25.220	3908	4	104.00	Turbo	85/116	BV520 (Fibre), 1.35mm BS340 (Fibre), 1.58mm	DH145 ▲	GH145 ▲○
10	8040.45.4180	3908	4	104.00	Turbo Intercooled	100/136	BV520 (Fibre), 1.35mm BS340 (Fibre), 1.58mm	DV520 ▲○ [7]	GV520 ▲○
11	BF4L 913 T F4L 913	4086 4086	4 4	102.00 102.00	Turbo	64-78/ 87-106 64/87	BM780 (Steel)	HL210 ▲	
12	C02 D	4397	4	108.00				CL611 ▲○	FL611 ▲○ [7]
13	8340.04/8340.04.R.001	4570	4	115.00			BD830 (Fibre)	DD832 ■○	GD832 ○
14	8340.04.040 8340.04.200/8340.04.250/ 8340.04.300/8340.04.350 8340.04.362	4570 4570 4570	4 4 4	115.00 115.00 115.00		73/99 74/100 74/100	BD830 (Fibre)	DD832 ■○	GD832 ○
15	213 H/213.000	4678	6	95.00	Boxer			CL233 ▲○ [7]	
16	806 A (8060.01/:11)	4678	6	95.00				CN470 ▲○ [7]	FN470 ▲○ [7]
17	8060.02.001/8060.02.003	5184	6	100.00		90/122	AN470 (Fibre)	CN470 ▲○ [7]	FN470 ▲○ [7]
18	8340.05.200	5401	4	115.00		84/114	BD830 (Fibre)	DD832 ■○	GD832 ○
19	8060.04/8060.04.055 8060.04.070/8060.04.620/ 8060.04.621/8060.04.658	5499 5499	6 6	103.00 103.00		96/131 99/135	BV710 (Fibre), 1.35mm BW160 (Fibre), 1.58mm	DH158 ▲○	GH15A ▲○
20	8060.24.670/8060.24.671	5499	6	103.00	Turbo	118/160	BV710 (Fibre), 1.35mm BW160 (Fibre), 1.58mm	DH159 ▲ [7]	GH15B ▲○
21	8062.24.070	5499	6	103.00	Turbo	118/160			
22	8060.24	5500	6	103.00	Turbo		BV710 (Fibre), 1.35mm BW160 (Fibre), 1.58mm	DH159 ▲ [7]	GH15B ▲○

JC732 ■ JD229 ■ (x4) JE476	JN192 (ACM)	HC466 ■			KA499 [10] LS051 [49] HJ069 [13] ■		
JC732 ■ JD229 ■ (x4)	JN935 (Viton)	HC480 ■		NA5040 ■ 110x135x13mm, FPM	LR948 [10] HJ070 [13] ■		
JC732 ■ JD229 ■ (x4)	JN935 (Viton)	HC480 ■		NA5041 ■ 42x65x12mm, ACM NA5040 ■ 110x135x13mm, FPM	KA499 [10] LR948 [10]		
JC732 ■ JD229 ■	JN935 (Viton)	HC480 ■					
JC732 ■ JD229 ■	JN935 (Viton)	HC466 ■ HC480 ■					
JC732 ■ JD5350 ■ JD229 ■ (x4)	JN935 (Viton)	HC480 ■		NA5040 ■ 110x135x13mm, FPM	LR948 [10] HJ070 [13] ■		
JC732 ■ JD229 ■ (x4)	JN935 (Viton)	HC480 ■		NA5040 ■ 110x135x13mm, FPM	LR948 [10]		
JC732 ■ JD229 ■ (x4)	JN935 (Viton)	HC466 ■ HC480 ■		NA5040 ■ 110x135x13mm, FPM	KA499 [10] LR948 [10] HJ070 [13] ■		
JC732 ■ JD229 ■ (x4)	JN935 (Viton)	HC466 ■ HC480 ■					
JD5350 ■ JD229 ■ (x4)	JN935 (Viton)	HC480 ■		NA5040 ■ 110x135x13mm, FPM	LR948 [10] HJ070 [13] ■		
JB188 ■	JM869			NB938 ■ 65x85x13mm, FPM NB939 ■ 115x140x16mm, FPM			
JA866 ■		HC118 ■	PA159		HJ057 [13] ■		
JC234 ■	JN312	HC413 ■ HC413 ■					
JC732 ■ JD229 ■ (x6)	JM661 (NBR)			NA5039 95x120x13mm, FPM	KA499 [10] LR948 [10] LS051 [49] HJ070 [13] ■		
JC732 ■ JD229 ■ (x6)	JM661 (NBR)	HC127 ■		NA5039 95x120x13mm, FPM	KA499 [10] LR948 [10] LS048 [50] LS051 [49] HJ070 [13] ■		
JC234 ■ (x3) JD229 ■ (x6)	JN312 JM661 (NBR)	HC413 ■ HC127 ■	KG936	NA5040 ■ 110x135x13mm, FPM	KA499 [10] LS048 [50] LS051 [49] HJ070 [13] ■		
JD229 ■ (x6)	JM661 (NBR)	HC127 ■			KA499 [10]		
	JM661 (NBR)						
JC732 ■ JD229 ■ (x6)	JM661 (NBR)	HC127 ■			KA499 [10] JE150 (x2) [51] [52]		



cc



kW/PS

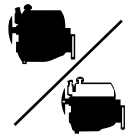

23	8060.04.672	5500	6	103.00		73/99	BV710 (Fibre), 1.35mm BW160 (Fibre), 1.58mm	DH158 ▲○	GH15A ▲○				
	8060.04.630/8060.04.639/ 8060.04.670/8060.04.675	5500	6	103.00		99/135							
24	8060.04.060	5500	6	103.00		96/131	BV710 (Fibre), 1.35mm BW160 (Fibre), 1.58mm	DH158 ▲○	GH15A ▲○				
	8060.04.660	5500	6	103.00		96-99/ 131-135							
	8060.04.669/8060.04.689	5500	6	103.00		99-102/ 135-139							
25	8060.24.678	5500	6	103.00	Turbo	123/167	BV710 (Fibre), 1.35mm BW160 (Fibre), 1.58mm	DH159 ▲[7]	GH15B ▲○				
	8060.24.601	5500	6	103.00	Turbo	124/168							
26	8060.45B.4300/ 8060.45R.4245	5861	6	104.00			BV710 (Fibre), 1.35mm BW160 (Fibre), 1.58mm	DV710 ▲○	GV710 ▲○				
	8060.45K.6090	5861	6	104.00	Euro 1/Turbo Intercooled								
27	8060.45S.6203	5861	6	104.00	Turbo		BV710 (Fibre), 1.35mm BW160 (Fibre), 1.58mm	DV710 ▲○	GV710 ▲○				
	8060.25R.4200	5861	6	104.00	Turbo	105/143							
	8060.25R.4300	5861	6	104.00	Turbo Intercooled	105/143							
	8060.25R.4200 LTC/ 8060.25R.4280	5861	6	104.00	Turbo	105/143							
	8060.25R.4750	5861	6	104.00	Turbo Intercooled	105/143							
	8060.25R.4755	5861	6	104.00	Turbo	105/143							
	8060.25R.4760/ 8060.25R.4764	5861	6	104.00	Turbo Intercooled	105/143							
	8060.45R.5000/ 8060.45R.5001/ 8060.45R.5003/ 8060.45R.5005/ 8060.45R.5050/ 8060.45R.5051	5861	6	104.00	Turbo	105/143							
	8060.25V.4080/ 8060.25V.4800	5861	6	104.00	Turbo Intercooled	130/177							
	8060.45.4100	5861	6	104.00	Turbo	152/207							
	8060.45.4100 TCA	5861	6	104.00	Euro 1/Turbo	152/207							
	8060.45.4180/ 8060.45.4300/ 8060.45.4400/ 8060.45L.4400/ 8060.45.4700	5861	6	104.00	Turbo	152/207							
	8060.45.4702/ 8060.45.4704/8060.45.4706	5861	6	104.00	Euro 1/Turbo	152/207							
	8060.45.4708/ 8060.45.5250/ 8060.45.5251/ 8060.45.5255	5861	6	104.00	Turbo	152/207							
	8060.45A.4100	5861	6	104.00	Turbo Intercooled	152/207							
	8060.45.6090	5861	6	104.00	Turbo	167/227							
	8060.45S.TCA	5861	6	104.00	Turbo Intercooled	167/227							
	8060.45S.6000/ 8060.45S.6800	5861	6	104.00	Turbo	167/227							
	28	8060.45S.7200	5861	6	104.00	Euro 2/Turbo Intercooled					BV710 (Fibre), 1.35mm BW160 (Fibre), 1.58mm	DV710 ▲○	GV710 ▲○
		8060.45B.5100	5861	6	104.00	Euro 2/Turbo Intercooled				152-130/ 207-177			

						<p>BV710, BW160</p> <p>JC732</p> <p>JD229</p> <p>JM661</p> <p>JN748</p> <p>HC127</p> <p>HC479</p>
JD229 [x6]	JM661 (NBR)	HC127	KG936	NA5040 110x135x13mm, FPM	KA499 [10] LS048 [50] LS051 [49] HJ070 [13]	
JD5350 JD229 (x6)	JM661 (NBR)	HC127	KG936	NA5040 110x135x13mm, FPM	KA499 [10] LS048 [50] LS051 [49] HJ070 [13]	
JD5350 JD229 (x6)	JM661 (NBR)	HC127	KG936	NA5040 110x135x13mm, FPM	KA499 [10] LS048 [50] LS051 [49] HJ070 [13]	
JC732 JD229 (x6)	JN748 (Viton)	HC479				
JC732 JD229 (x6)	JN748 (Viton)	HC479			HJ070 [13] JE150 [51][52]	
JC732 JD229 (x6)	JN748 (Viton)	HC479			HJ070 [13] JE150 (x2)[51][52]	



cc



kW/PS

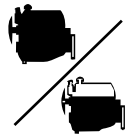

29	8060.05/8060.05.270/ 8060.05.280/8060.05.285/ 8060.05.289	5861	6	104.00		101/137	BV710 (Fibre), 1.35mm BW160 (Fibre), 1.58mm	DH157 ▲○	GH159 ○
30	8060.25.669 8060.25.678/8060.25.679	5861 5861	6 6	104.00 104.00	Turbo Turbo	125/170 130/177	BV710 (Fibre), 1.35mm BW160 (Fibre), 1.58mm	DH157 ▲○ DV711 ▲	GV711 ▲○
31	8060.25.670	5861	6	104.00	Turbo	125/170	BV710 (Fibre), 1.35mm BW160 (Fibre), 1.58mm	DH157 ▲○ DV711 ▲	GV711 ▲○
32	8060.05.200	5868	6	104.00		99-102/ 135-139	BV710 (Fibre), 1.35mm BW160 (Fibre), 1.58mm	DH157 ▲○	GH159 ○
33	8060.05.246	5868	6	104.00		101/137	BV710 (Fibre), 1.35mm BW160 (Fibre), 1.58mm	DH157 ▲○	GH159 ○
34	8060.25.600	5868	6	104.00	Turbo	130/177	BV710 (Fibre), 1.35mm BW160 (Fibre), 1.58mm	DV711 ▲	GV711 ▲○
35	8060.25V.4000	5868	6	104.00	Turbo Intercooled	130/177	BV710 (Fibre), 1.35mm BW160 (Fibre), 1.58mm	DV710 ▲○	GV710 ▲○
36	BF6L 913 T F6L 913 BF6L 913 BF6L 913/U	6128 6128 6128 6128	6 6 6 6	102.00 102.00 102.00 102.00	Turbo Turbo Turbo	96-112/ 131-152 96/131 118-124/ 160-169 124/168	BM780 (Steel) (x6)	HL210 ▲	
37	8360.04	6855	6	115.00			AY020 (Fibre)	DD843 ○	GD843 ○
38	8360.46R.416 (TCA) 8360.46 8360.46.417/ 8360.46.417 (TCA)	7685 7685 7685	6 6 6	112.00 112.00 112.00	Turbo Intercooled Euro 1/Turbo Intercooled Turbo	176/240 196/226 196/266	BW120 (Fibre)	DW120 ▲ [7]	GW120 ▲
39	F2BE 0681 D F2BE 0681 C F2BE 0681 F F2BE 0681 B F2BE 0681 A	7790 7790 7790 7790 7790	6 6 6 6 6	115.00 115.00 115.00 115.00 115.00	Cursor 8-240/Euro 2/ Turbo Intercooled Cursor 8-270 I/Euro 2/ Turbo Intercooled Cursor 8-270 R/Euro 2/ Turbo Intercooled Cursor 8-310/Euro 2/ Turbo Intercooled Cursor 8-350/Euro 2/ Turbo Intercooled	180/245 200/272 200/272 228/310 259/352	AA5010 (MLS)	CA5010 ▲■	FA5010 ▲
40	8361.05	8102	6	115.00			AY020 (Fibre)		GD846 ▲○ [7]
41	8360.05.673 8360.05.200/8360.05.254	8102 8102	6 6	115.00 115.00		118-121/ 160-165 124/168	AY020 (Fibre)	DD843 ○	GD843 ○
42	220 H/8200.11/ 8200.01.220 - 620.001/021 - 8200.11	9161	6	120.00			AL640 (Fibre) (x2)	CM834 ▲○ [7]	
43	8460.21.601/8460.21.611	9498	6	120.00	Turbo		BS350 (Fibre) (x2)	DS350 ▲○	GS350 ▲○
44	8460.21B.613/8460.21B.615	9500	6	120.00			BS350 (Fibre) (x2)	DS350 ▲○	GS350 ▲○

JC732 ■ JD229 ■ (x6)	JN748 (Viton)	HC479 ■			KA499 [10]
JC732 ■ JD229 ■ (x6)	JN748 (Viton)	HC479 ■			
JC732 ■ JD229 ■ (x6)	JN748 (Viton)	HC479 ■			
JC732 ■ JD229 ■ (x6)	JN748 (Viton)	HC479 ■		NA5040 ■ 110x135x13mm, FPM	KA499 [10]
JC732 ■ JD229 ■ (x6)	JN748 (Viton)	HC479 ■			KA499 [10]
JC732 ■ JD229 ■ (x6)	JN748 (Viton)	HC479 ■		NA5041 ■ 42x65x12mm, ACM NA5042 ■ 114x135x13mm, FPM	HJ070 [13] ■ JE150 (x2) [51] [52]
JC732 ■ JD229 ■ (x6)	JN748 (Viton)	HC479 ■		NA5041 ■ 42x65x12mm, ACM NA5042 ■ 114x135x13mm, FPM	HJ070 [13] ■ JE150 (x2) [51] [52]
JB188 ■ (x6)	JM869			NB938 ■ 65x85x13mm, FPM NB939 ■ 115x140x16mm, FPM	
JC234 ■ (x3)	JN222 (x2)	HC416 ■			HJ070 [13] ■
JC234 ■ JD584 ■	JN222 (x2)	JJ593			
JA5009 ■	JM5004	JH5001	HR602 ■ (x12)		HBS485 [8]
JC234 ■ (x3)	JN222 (x2)	HC416 ■			HJ070 [13] ■
JA894 ■					HJ240 [13] ■ KK5608 [53] KD930 [51] [54] (Steel) LS109 [55]
JC267 ■ JC268 ■	JN745 (x2)	JJ191			HT031 [14] ■ HT032 [14] ■ HT033 [14] ■ HT034 [14] ■ PB047 [14] ■ KK5608 [53] KD930 [51] [54] (Steel)
	JN745 (x2)	JJ191			KK5608 [53] KD930 [51] [54] (Steel)

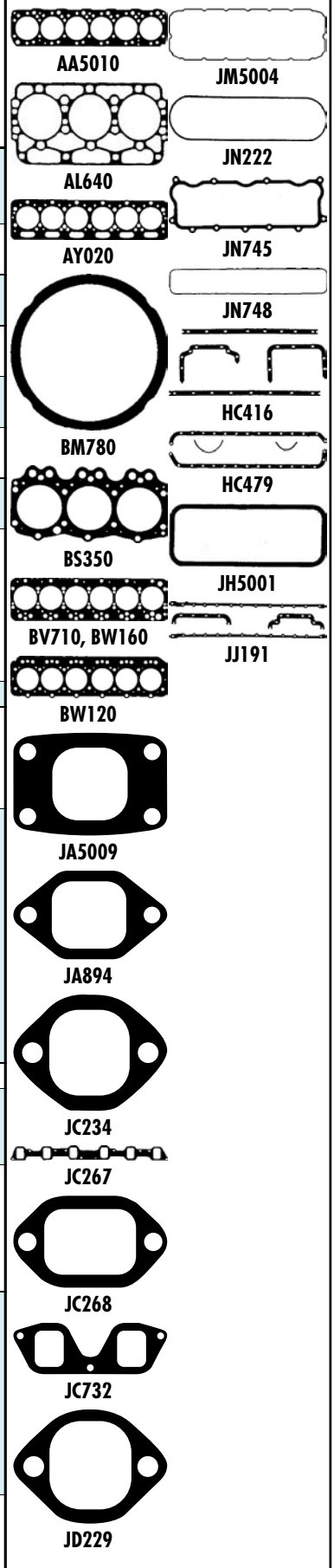









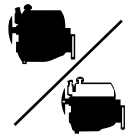



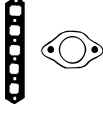

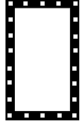

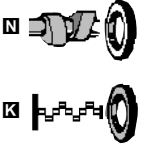
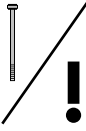
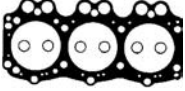





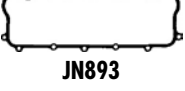
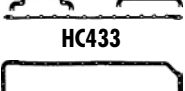

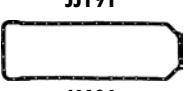









































cc



kW/PS



45	8460.41	9500	6	120.00	Turbo Intercooled		BS350 (Fibre) (x2)	DS350 ▲○	GS350 ▲○
46	8460.21.002/8460.21.010 8460.21.102 8460.41.124 8460.41.160	9500 9500 9500 9500	6 6 6 6	120.00 120.00 120.00 120.00	Turbo Turbo Turbo Intercooled Turbo Intercooled	177/240 191/260 234/318 236/321	BS350 (Fibre)	DS350 ▲○	GS350 ▲○
47	8460.21.202/8460.21.206 8460.41 R	9500 9500	6 6	120.00 120.00	Turbo Turbo Intercooled	177/240 214-276/ 290-375	BS350 (Fibre)	DS351 ▲○	GS351 ▲○
48	8460.41C 8460.41C (TCA) 8460.41C.320 8460.41K 8460.41K. TCA 8460.41K.406/8460.41K.410 8460.41L (TCA)/ 8460.41L.5020	9500 9500 9500 9500 9500 9500 9500	6 6 6 6 6 6 6	120.00 120.00 120.00 120.00 120.00 120.00 120.00	Turbo Turbo Intercooled Turbo Turbo Euro 1/Turbo Turbo Turbo	221/301 221/301 221/301 254/345 254/345 254/345 276/375	BS350 (Fibre)	DS351 ▲○	GS351 ▲○
49	8460.41.102	9500	6	120.00	Turbo Intercooled	234/318	BS350 (Fibre)	DS350 ▲○	GS350 ▲○
50	8460.41 S 8460.41N 8460.41 M	9500 9500 9500	6 6 6	120.00 120.00 120.00	Euro 2/Turbo Turbo Intercooled	254/345 276/375 278/378	BS350 (Fibre)	DS351 ▲○	GS351 ▲○
51	8220.02	9572	6	125.00			BR390 (Fibre) (x2)	DR393 ○	GR393 ○
52	8220.12	9572	6	125.00			AY370 (Fibre) (x2)	DR402 ■○	GH671 GR402 ○

						 <p>AY370</p>  <p>BR390</p>  <p>BS350</p>  <p>JC267</p>  <p>JC268</p>  <p>JC458</p>  <p>JN745</p>  <p>JN893</p>  <p>HC433</p>  <p>JJ190</p>  <p>JJ191</p>  <p>JJ406</p>
JC268 	JN745 (x2)	JJ191			HT031 [14]  HT032 [14]  HT033 [14]  HT034 [14]  PB047 [14]  KK5608 [53] KD930 [51][54] (Steel)	
JC267  JC268 	JN745 (x2)	JJ191			HT031 [14]  HT032 [14]  HT033 [14]  HT034 [14]  PB047 [14]  KK5608 [53] KD930 [51][54] (Steel)	
JC267 	JN745	JJ191			HT031 [14]  HT032 [14]  HT033 [14]  HT034 [14]  PB047 [14]  KK5608 [53] KD930 [51][54] (Steel)	
JC267 	JN745	JJ406			HT031 [14]  HT032 [14]  HT033 [14]  HT034 [14]  PB047 [14]  KK5608 [53] KD930 [51][54] (Steel)	
JC267 	JN745 (x2)	JJ191			HT031 [14]  HT032 [14]  HT033 [14]  HT034 [14]  PB047 [14]  KK5608 [53] KD930 [51][54] (Steel)	
JC267 	JN745 (x2)	JJ406			HT031 [14]  HT032 [14]  HT033 [14]  HT034 [14]  PB047 [14]  KK5608 [53] KD930 [51][54] (Steel)	
JC268  (x6)	JN893 (x2)	JJ190 JJ191			HT026 [14]  HT027 [14]  HT028 [14]  HT029 [14]  HT030 [14] 	
JC458  JC268  (x6)	JN893 (x2)	HC433 			HT026 [14]  HT027 [14]  HT028 [14]  HT029 [14]  HT030 [14] 	



cc



kW/PS

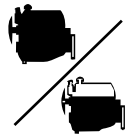

53	8220.32	9572	6	125.00	Turbo		AY370 (Fibre) (x2)	DR401 ○	
54	8220.02.870	9572	6	125.00		148/201	BR390 (Fibre) (x2)	DR393 ○	GR393 ○
55	8220.22.002	9572	6	125.00	Turbo	177/240	BR390 (Fibre) (x2)	DR392 ■○	GR392 ○
56	8220.22.102	9572	6	125.00	Turbo	177/240	BR390 (Fibre) (x2)	DR392 ■○	GR392 ○
57	8200.02	9820	6	122.00			AN360 (Fibre) (x2) AX700 (Fibre) (x2)	DC551 ▲○	GC551 ▲○
58	F3A3681A F3A3681B F3A3681Y	10300 10300 10300	6 6 6	125.00 125.00 125.00	Cursor 10 E 45/Euro 4/5/ Turbo Intercooled Cursor 10 E 42/Euro 4/5/ Turbo Intercooled Cursor 10 E 46/Euro 4/5/ Turbo Intercooled		AG9350 (SE)	CA5600 ■▲	FA5600 ▲
59	F3AE 0681 E F3AE 0681 B F3AE 0681 D	10300 10300 10300	6 6 6	125.00 125.00 125.00	Cursor 10-390/Euro 2/ Turbo Intercooled Cursor 10-400/Euro 3/ Turbo Intercooled Cursor 10-430/Euro 2/ Turbo Intercooled	287/390 294/400 316/430	AG9350 (SE)	CA5600 ■▲	FA5010 ▲ FA5600 ▲
60	8200.03	10308	6	125.00			BC550 (Fibre) (x2)	DC551 ▲○	GC551 ▲○
61	8200.13	10308	6	125.00				DC200 ▲	
62	203.000	10676	6	125.00			AL330 (Fibre) (x2)	CL356 ▲■○	
63	310 H/61	11548	6	130.00			AL350 (Fibre) (x2) AL360 (Fibre) (x2) [15]	CL356 ▲■○	
64	203 A/61 203 A/61.000	11548 11548	6 6	130.00 130.00		130/177 132/179	AL350 (Fibre) AL360 (Fibre) [15]	CL356 ▲■○	FL35D ▲○ [7]
65	203 H 61	11548	6	130.00		132/180	AL350 (Fibre) AL360 (Fibre) [15]	CL356 ▲■○	
66	F8L 413 F	12763	8	125.00	V	162-212/ 220-288		HL363 ▲ (x8) [4] HL399 ▲ (x8) [5]	
67	BF8L 413 F BF8L 513	12763 12763	8 8	125.00 125.00	Turbo/V Turbo/V	212/288 225-250/ 306-340		HL399 ▲ (x8) [5]	

JC267	JN893 (x2)	HC433			HT026 [14]							AG9350	JM5026
JC268 (x6)					HT027 [14]							AN360	JN893
JC268 (x6)	JN893	JJ190 JJ191			HT028 [14]							AX700	HC104
JC267	JN893 (x2)	JJ191			HT029 [14]							AY370	JJ190
JC268 (x6)					HT030 [14]							BC550	JJ191
JA893					JR843 [11]							BR390	
JA894					HT026 [14]							JA849	
JE639 (x2)					HT027 [14]							JA893	
JE5005	JM5026	JH5071 (Cork)			HT028 [14]							JA894	
JE5005	JM5026	JH5071 (Cork)			HT029 [14]							JC267	
JE639 (x2)					HT030 [14]							JC268	
JE639 (x2)					HJ240 [13]							JE639	
JA849		HC104			KV477 [55]								
JA849		HC104			LA602 [55]								
JA849		HC104			HL5003 [14]								
JA849		HC104											
JD172					HJ240 [13]								
JD172					KV477 [55]								
					LA602 [55]								
					HJ240 [13]								
					KV482 [55]								
					NB934 100x120x15mm, FPM								
					NB935 105x130x15mm, FPM								
					NB934 100x120x15mm, FPM								
					NB935 105x130x15mm, FPM								







cc

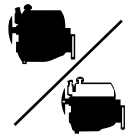

kW/PS

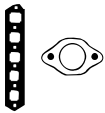

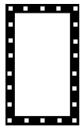
68	F3B3681A	12880	6	135.00	Cursor 13 E 56/Euro 4/5/ Turbo Intercooled		AG9360 (MLS)	CG9361	FG9361
	F3B3681B	12880	6	135.00	Cursor 13 E 50/Euro 4/5/ Turbo Intercooled				
	F3B3681C	12880	6	135.00	Cursor 13 E 45/Euro 4/5/ Turbo Intercooled				
	F3B3681D	12880	6	135.00	Cursor 13 E 41/Euro 4/5/ Turbo Intercooled				
	F3B3681E	12880	6	135.00	Cursor 13 E 48/Euro 4/5/ Turbo Intercooled				
	F3B3681G	12880	6	135.00	Cursor 13 E 44/Euro 4/5/ Turbo Intercooled				
	F3BE3681C	12880	6	135.00	Cursor 13 E 45/Euro 4/5/ Turbo Intercooled	332/450			
	F3BE3681B	12880	6	135.00	Cursor 13 E 50/Euro 4/5/ Turbo Intercooled	368/500			
69	F3BE 0681 G	12880	6	135.00	Cursor 13-380/Euro 3/ Turbo Intercooled	280/380	AG9360 (MLS)	CG9360	FG9360 [7]
	F3BE 0681 C	12880	6	135.00	Cursor 13-440/Euro 3/ Turbo Intercooled	324/440			
	F3BE 0681 E	12880	6	135.00	Cursor 13-480/Euro 3/ Turbo Intercooled	353/480			
	F3BE 0681 B	12880	6	135.00	Cursor 13-500/Euro 3/ Turbo Intercooled	368/500			
70	F3BE 0681 A	12880	6	135.00	Cursor 13-540/Euro 3/ Turbo Intercooled	397/540	AG9360 (MLS)	CG9360	FG9360 [7]
71	8260.02	12880	6	145.00			BH790 (SE), 1.20mm (x6)	DH797 ▲○ [7]	GH794 ▲○
72	8261.02.002	12880	6	145.00			BH790 (SE), 1.20mm		
73	F3BE3681D	12882	6	135.00	Euro 4/5/Turbo Intercooled	302/410	AG9360 (MLS)	CG9361	FG9361
	F3BE3681G	12882	6	135.00	Euro 4/5/Turbo Intercooled	324/440			
	F3BE3681F	12882	6	135.00	Euro 4/5/Turbo Intercooled	353/480			
	F3BE3681E	12882	6	135.00	Euro 4/5/Turbo Intercooled	382/520			
	F3BE3681A	12882	6	135.00	Euro 4/5/Turbo Intercooled	412/560			
74	F3BE0681D	12882	6	135.00	Turbo Intercooled	330/450	AG9360 (MLS)		FG9361
75	F8L 513	13383	8	128.00	V	168-194/ 228-264		HL363 ▲ (x8) [4] HL399 ▲ (x8) [5]	
76	8210.42L	13790	6	137.00	Euro 2/Turbo	309/420	BW151 (x2) →Eng.456043 Euro 2 →Eng.456220 Euro 1	DW151 ▲○	GW151 ▲○
							BY401 (x2) 03/96→ Eng.456044→ Eng.456221→		
77	8210.22.800	13798	6	137.00			BW151 (x2) →Eng.456043 Euro 2 →Eng.456220 Euro 1	DW150 ▲○ [7]	
							BY401 (x2) 03/96→ Eng.456044→ Eng.456221→		

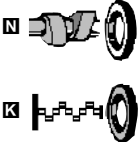
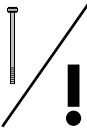
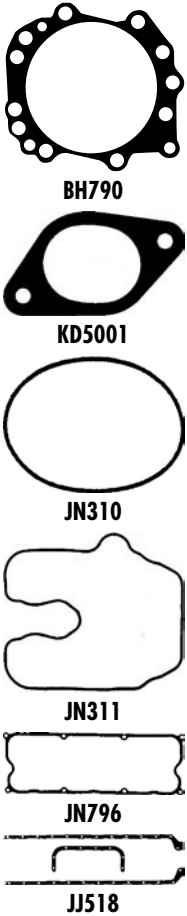
						
JD5939 ■ (x2) (Steel)	JM7064 (ACM)	JH5169 (Rubber)				
JD5939 ■ (x2) (Steel) JD5938 ■ (x6) (Graphite)	JM7064 (ACM)	JH5169 (Rubber)			HL5004 [14] ■	
JD5939 ■ (x2) (Steel) JD5938 ■ (x6) (Graphite)	JM7064 (ACM)	JH5071 (Cork) JH5169 (Rubber)			HL5004 [14] ■	
	JN310 ■ (x12) JN311 ■ (x6)				KL137 [14] ■	
	JN310 ■ (x12) JN311 ■ (x6)				KL137 [14] ■	
JD5939 ■ (x2) (Steel)	JM7064 (ACM)	JH5169 (Rubber)				
JD5939 ■ (x2) (Steel)	JM7064 (ACM)	JH5169 (Rubber)				
JD172 ■				<input checked="" type="checkbox"/> NB934 ■ 100x120x15mm, FPM <input checked="" type="checkbox"/> NB935 ■ 105x130x15mm, FPM		
KD5001 ■ ■ ■	JN796 (x2)	JJ518 (Cork)			KV477 [55]	
KD5001 ■ ■ ■	JN796 (x2)	JJ518 (Cork)			KV477 [55]	



cc



kW/PS

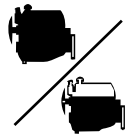

78	8210.02/8210.02.067/ 8210.02.069/8210.02.371/ 8210.02.373/8210.02.377/ 8210.02.393/8210.02.440/ 8210.02.441 8210.02.731	13798 13798	6 6	137.00 137.00	 Boxer	191/260 191/260	BL991 (SE) (x2)	DL994 ▲○	GL994 ▲○
79	8210.22.171/8210.22.175/ 8210.22.183/8210.22.210/ 8210.22.236/8210.22.269/ 8210.22.317/8210.22.327/ 8210.22.385/8210.22.511/ 8210.22.521/8210.22.523/ 8210.22.525/8210.22.535/ 8210.22.537/8210.22.569/ 8210.22X.069/ 8210.22X.235/ 8210.22X.523/ 8210.22X.575 8210.22.869 8210.22.105	13798 13798 13798	6 6 6	137.00 137.00 137.00	 Turbo Turbo Intercooled	224/305 235/320 243/330	BL991 (SE) (x2)	DL992 ▲■○	GL992 ▲○
80	8210.42.101 8210.42 TCA 8210.42.061/8210.42.073 8210.42	13798 13798 13798 13798	6 6 6 6	137.00 137.00 137.00 137.00	Turbo Intercooled Turbo Intercooled Turbo Intercooled	265/360 272/370 277/377 346/470	BL991 (SE) (x2)	DL993 ▲○	GL993 ▲○
81	8210.42.115/8210.42.210/ 8210.42.235/8210.42.237/ 8210.42.269 8210.42.270/8210.42.271 8210.42.500	13798 13798 13798	6 6 6	137.00 137.00 137.00	Turbo Intercooled Turbo Euro 2/Turbo Intercooled	265/360 265/360 346/471	BW151 (x2)	DL993 ▲○	GL993 ▲○
82	8210.42K	13798	6	137.00	Turbo Intercooled	272/370	BW151 (x2) →03/96 →Eng.456043 Euro 2 →Eng.45620 Euro 1 BY401 (x2) 03/96→ Eng.456044→ Eng.456221→	DW151 ▲○	GW151 ▲○
83	8210.42K 8210.42K	13798 13798	6 6	137.00 137.00	Euro 1/Turbo Turbo Intercooled	272/370 272/370	BW151 (x2) →03/96 →Eng.456043 Euro 2 →Eng.456220 Euro 1 BY401 (x2) 03/96→ Eng.456044→ Eng.456221→	DW151 ▲○	GW151 ▲○
84	8210.42.151/8210.42.152/ 8210.42.154/8210.42.155/ 8210.42.161/8210.42.162/ 8210.42.165/8210.42.171/ 8210.42.172/8210.42.175/ 8210.42.181/8210.42.182/ 8210.42.185/8210.42.186/ 8210.42.191/8210.42.195	13798	6	137.00	Turbo Intercooled	277/377	BL991 (SE) (x2) BW151 (x2) →03/96 →Eng.456043 Euro 2 →Eng.456220 Euro 1	DL993 ▲○	GL993 ▲○

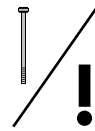
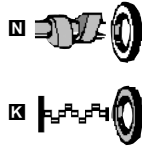
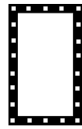
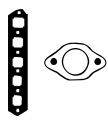

JC873



JC874



KD5001



JN796



JJ518

JC874 ■ (x2) JC873 ■ (x2)	JN796 (x2)	JJ518 (Cork)			LT987 [56] KV477 [55] LA602 [55] LS109 [55]
JC874 ■ (x2) JC873 ■ (x2)	JN796 (x2)	JJ518 (Cork)			KV477 [55] LA602 [55]
JC874 ■ (x2) JC873 ■ (x2)	JN796 (x2)	JJ518 (Cork)			KV477 [55] LA602 [55]
JC874 ■ (x2) JC873 ■ (x2)	JN796 (x2)	JJ518 (Cork)			KV477 [55] LA602 [55]
KD5001 ■ ■ ■	JN796 (x2)	JJ518 (Cork)			KV477 [55]
KD5001 ■ ■ ■	JN796 (x2)	JJ518 (Cork)			KV477 [55]
JC874 ■ (x2) JC873 ■ (x2)	JN796 (x2)	JJ518 (Cork)			KV477 [55] LA602 [55]



cc





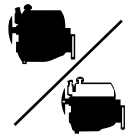





kW/PS



85	8210.42L	13798	6	137.00	Turbo	309/420	BW151 (x2)	DW151 ▲○	GW151 ▲○
	8210.42L.400	13798	6	137.00	Euro 1/Turbo	309/420	→03/96		
	8210.42L (TCA)	13798	6	137.00	Turbo Intercooled	345/469	→Eng.456043 Euro 2		
	8210.42M (TCA)	13798	6	137.00	Euro 2/Turbo Intercooled	345/470	→Eng.456220 Euro 1		
	8210.42M	13798	6	137.00		346/470	BY401 (x2) 03/96→ Eng.456044→ Eng.456221→		
86	F10L 413 F	15953	10	125.00	Turbo/V	235/320		HL363 ▲ [4] HL399 ▲ [5]	
87	8280.42B	17173	8	145.00	V	324/440	BH790 (SE), 1.20mm (x8)		GH795 ○
88	8280.42S (TCA)	17173	8	145.00	Turbo Intercooled/V	378/514	BK490 (x8) BH790 (SE), 1.20mm (x8)	DH798 ○ [7]	GH795 ○
89	8280.02.269	17174	8	145.00	V		BK490 (x8) BH790 (SE), 1.20mm (x8)	DH793 ■○ (x8) DH79A ○ [16]	GH797 ○
90	8280.02.109	17174	8	145.00	V	259/352	BK490 (x8) BH790 (SE), 1.20mm (x8)	DH793 ■○ (x8) DH79A ○ [16]	GH797 ○
91	8280.22.	17174	8	145.00	V	280/381	BK490 (x8)	DH799 ■○	GH796 ○
	8280.22.007/8280.22.033/ 8280.22.054	17174	8	145.00	Turbo/V	280/381	BH790 (SE), 1.20mm (x8)		
	8280.22.154	17174	8	145.00	Turbo Intercooled/V	280/381			
	8280.22.201	17174	8	145.00	Turbo Intercooled/V	309/420			
92	8280.22.205	17174	8	145.00	Turbo Intercooled/V	309/420	BK490 (x8) BH790 (SE), 1.20mm (x8)	DH793 ■○ (x8) DH799 ■○	GH796 ○
93	8280.42.001/8280.42.050	17174	8	145.00	Turbo Intercooled/V	350/476	BK490 (x8)	DH798 ○ [7]	GH795 ○
	8280.42S.350	17174	8	145.00	Turbo Intercooled/V	375/510	BH790 (SE), 1.20mm (x8)		
	8280.42S.342	17174	8	145.00	Euro 2/Turbo Intercooled/V	378/514			
	8280.42S.352/8280.42S.362	17174	8	145.00	Turbo Intercooled/V	378/514			
94	8280.22.009	17200	8	145.00	Turbo/V	280/381	BK490 (x8) BH790 (SE), 1.20mm (x8)	DH799 ■○	GH796 ○

KD5001 [1] [S]	JN796 (x2)	JJ518 (Cork)			KV477 [55]	
JD172 [E]				NB934 [E] 100x120x15mm, FPM NB935 [E] 105x130x15mm, FPM		
	JN310 [x16] JN311 [x16]	JH5062			HL5081 [14] [S] KL137 [14] [S] JE150 [51][52]	
	JN310 [x16] JN311 [x16]				HL5080 [14] [S] KL137 [14] [S] HJ285 [13] [S]	
	JN310 [x16] JN311 [x16]				HL5080 [14] [S] KL137 [14] [S] HJ285 [13] [S]	
	JN310 [x16] JN311 [x16]	JH5062			HL5080 [14] [S]	
	JN310 [x16] JN311 [x16]	JH5062			HL5080 [14] [S] KL137 [14] [S] HJ285 [13] [S] JE150 [51][52]	
KD5002 [E]	JN310 [x16] JN311 [x16]	JH5062			HL5081 [14] [S] KL137 [14] [S] JE150 [51][52]	
	JN310 [x16] JN311 [x16]				HL5080 [14] [S]	

		cc			9			cc			9
0.401	Diesel	6540	6	107.19	18						
0.401	Diesel	6540	6	107.19	19						
0.410	Diesel	6540	6	107.22	20						
0.680/4000/8/9/11	Diesel	11100	6	127.01	24						
0.680/4001/7/10	Diesel	11100	6	127.01	25						
0.680/4002/3/4	Diesel	11100	6	127.01	26						
0.690	Diesel	11100	6	127.01	27						
0680 P.P.MK3	Diesel	111s00	6	127.01	28						
12J	Diesel	2494	4	90.47	2						
3.4T/TA	Diesel	3400	4	95.00	3						
3.5L Carburettor	Petrol	3528	8	88.86	4						
3.5V8	Petrol	3528	8	88.86	5						
38T/TA	Diesel	3770	4	100.00	6						
38TD	Diesel	3770	4	100.00	7						
38VD	Diesel	3770	4	100.00	8						
4/98 NV	Diesel	3770	4	98.00	9						
4/98DT	Diesel	3770	4	98.00	10						
4/98NT	Diesel	3770	4	98.00	11						
4/98TT	Diesel	3770	4	98.00	12						
411/420	Diesel	6540	6	107.22	21						
51UD	Diesel	5103	6	95.00	13						
57J/57JC/57VD	Diesel	5655	6	100.00	16						
6.354.4	Diesel	5800	6	98.47	17						
6/98 DT/NT	Diesel	5650	6	98.00	14						
6/98 DV/NV	Diesel	5650	6	98.00	15						
AD3.152	Diesel	2500	3	91.49	1						
KT191	Diesel	11630	6	130.00	30						
0.400 P.P.MkI/II	Diesel	6540	6	107.19	22						
TL11	Diesel	11100	6	130.00	29						
V8.540	Diesel	8830	8	107.95	23						



21

9



21

9

Atlantean		26	Industrial FFK160	01/66→12/72	16
Atlantean	01/66→	27	Industrial FFK240	01/56→12/72	13
Bear	01/69→12/72	18	Industrial FFK300	01/56→12/72	13
Bear	01/72→12/73	20	Industrial FFK340	01/56→12/72	13
Bison 4BN	01/78→12/80	29	Industrial FFK360	01/56→12/72	13
Boxer Series	01/72→	15	Industrial FFK360	01/66→12/72	16
Boxer 1000	01/56→12/72	13	Industrial FG900	01/66→12/72	16
Boxer BX16TA	01/72→12/77	15	Industrial FG900	08/67→08/70	13
Boxer BX16TF	01/72→12/77	15	Industrial FGK100	11/61→08/70	13
Boxer BX18TF	01/72→12/77	17	Industrial FHK100	01/56→12/72	13
Boxer BX19TA	01/72→12/78	17	Industrial FHK140	01/66→12/72	16
Boxer BX19TF	01/72→12/78	17	Industrial FHK160	01/66→12/72	16
Boxer BX20TF	01/72→12/73	17	Industrial FJ950	01/56→12/72	13
Boxer BX984	01/74→12/82	15	Industrial FJ1160	01/56→12/72	13
Boxer BX1000	01/71→09/72	13	Industrial FJ160	01/66→12/72	16
Boxer BX1000	01/72→12/78	15	Industrial FJ1300	01/66→12/72	16
Boxer BX1043	01/78→12/84	15	Industrial FJK100	01/56→12/72	13
Boxer BX1200	01/72→12/78	15	Industrial FJK140	01/66→12/72	16
Boxer BX1235	01/78→12/84	15	Industrial FJK160	01/66→12/72	16
Boxer BX1300	01/72→12/78	15	Industrial FJK360	01/66→12/72	16
Boxer BX1325	01/78→12/84	15	Industrial FJT200	01/56→12/72	13
Boxer BX1425	01/69→12/82	17	Industrial FJT200	01/66→12/72	16
Boxer BX1450	01/74→12/82	15	Industrial FJT1500	01/56→12/72	13
Buffalo 4BU	01/78→12/80	29	Industrial FJT1500	01/66→12/72	16
Chieftain	01/65→12/69	22	Industrial FJT1800	01/56→12/72	13
Chieftain Super6 (CH13)	06/63→01/69	22	Industrial FJT1800	01/66→12/72	16
Chieftain Super6 (CH13)	02/69→08/72	18	Industrial TM100		17
Chieftain (CH40)	09/72→10/79	18	Industrial TM110		17
Chieftain (CH40)	09/72→11/79	20	Industrial TM135		17
Chieftain (CH40)	06/79→01/84	19	Industrial WEK100	01/55→12/67	13
Chieftain (CH40)	12/79→12/82	21	Industrial WF420	01/67→12/72	8
Chieftain (CH41)	09/72→10/79	18	Industrial WF600	01/67→12/72	8
Chieftain (CH41)	09/72→11/79	20	Industrial WF830	01/56→12/72	13
Chieftain (CH41)	06/79→01/84	19	Industrial WF830	01/66→12/72	16
Chieftain (CH41)	12/79→12/82	21	Industrial WFK100	07/64→08/70	13
Clydesdale	01/60→12/68	22	Industrial WFK120	01/66→12/67	16
Clydesdale (CD21)	09/60→12/68	22	Industrial WFK140	01/66→12/67	16
Clydesdale (CD21)	01/69→08/72	18	Invincible	01/58→12/61	28
Clydesdale (CD40)	09/72→12/82	18	Laird 950	01/68→09/72	13
Clydesdale (CD41)	09/72→12/82	18	Laird 1000	01/68→09/72	13
Clydesdale CD40	09/72→02/74	20	Laird LR950	01/66→12/72	16
Clydesdale CD40	09/72→12/82	18	Laird LR1000	01/66→12/72	16
Clydesdale CD40	06/79→10/82	19	Laird LR1200	01/66→12/72	16
Clydesdale CD40	11/79→12/82	21	Laird LR1300	01/66→12/72	16
Clydesdale CD41	09/72→02/74	20	Laird LR1800	01/66→12/72	16
Clydesdale CD41	09/72→12/82	18	Laird LR1825	01/66→12/72	16
Clydesdale CD41	06/79→10/82	19	Leopard		24
Clydesdale CD41	11/79→12/82	21	Leopard	01/59→	28
Comet (13C)	10/63→12/68	22	Leopard	01/66→	27
Constructor	01/89→	30	Low Loader 345FG 1.5 ton	09/72→12/76	9
Constructor 24.21	01/81→12/89	29	Low Loader 700FG 4 ton	09/72→10/75	9
Constructor 24.23	01/81→12/89	29	Lynx	01/79→12/80	29
Constructor 30.21	01/81→12/89	29	Mastiff MS1600	04/75→12/84	23
Constructor 30.26	01/81→12/89	29	Mastiff MS2600	04/75→12/84	23
Cruiser 16.18	01/81→12/89	29	Mastiff MS2800	04/75→12/84	23
Cruiser 16.21	01/81→12/89	29	National		24
Cruiser 16.23	01/81→12/89	29	National	01/66→	27
Cruiser 16.26	01/81→12/89	29	National	01/78→12/85	29
FC Series	01/56→12/72	13	NC Series	01/56→12/72	13
FG Series	01/72→	9	Octopus	01/78→12/80	29
Fleetline		27	Olympian	01/82→12/92	29
Freighter 11.11	01/82→12/87	15	Panther	01/66→	27
Freighter 13.11	01/82→12/87	15	Panther Cub	01/64→12/70	22
Freighter 14.11	01/82→12/87	15	Prime-mover 503	01/56→12/72	13
Freighter 15.11	01/82→12/87	15	Prime-mover 504	01/56→12/72	13
Guy Big J4	09/68→12/77	18	Prime-mover 701	01/56→12/72	13
Handyman		28	Prime-mover 704	01/56→12/72	13
Highwayman		28	Quiet Cab Tractor 245		1
Hippo	01/55→12/56	28	Reiver	01/60→12/69	22
Industrial		25	Reiver (2RE40)	09/72→08/73	18
Industrial FFK100	01/55→12/67	13	Reiver (RE25)	09/60→06/68	22
Industrial FFK140	01/56→12/72	13	Reiver (RE27)	09/60→06/68	22
Industrial FFK140	01/66→12/72	16	Reiver (RE41)	08/73→11/79	20



21 9

Reiver (RE41)	11/79→12/82	21
Roadrunner 6.11	01/84→12/86	15
Roadrunner 8.1	01/84→12/86	15
Roadrunner 10.12	01/84→12/86	15
Routeman	01/66→	27
Routeman II		28
Routeman III	01/70→12/79	28
Routeman III	01/78→12/80	29
Sherpa	01/72→08/90	5
Sherpa 350	11/85→12/89	4
Steer	01/47→12/61	28
Super Beaver	01/49→12/71	28
Super Clydesdale	02/69→08/72	18
Super Comet	01/72→02/74	20
Super Comet 2SC	05/68→02/74	18
Super Comet 14SC	09/60→01/68	22
Super Comet 16SC	09/60→01/68	22
Super Comet 16SCT	05/68→02/74	18
Super Hippo	01/49→12/71	28
Super Mastiff SM2200	04/75→12/84	23
Super Mastiff SM2400	04/75→12/84	23
Super Reiver	01/60→12/69	22
Super Reiver 20RE33	06/66→12/68	22
Super Reiver 20RE35	06/66→12/68	22
Super Reiver 20RE33	12/68→08/72	18
Super Reiver 20RE35	12/68→08/72	18
Super Reiver RE29	01/64→01/69	22
Super Reiver RE29	02/69→08/72	18
Super Reiver RE31	01/64→01/69	22
Super Reiver RE31	02/69→08/72	18
Terrier Series	01/72→	9
Terrier 4 ton TR650	09/72→07/84	9
Terrier 5 ton TR750	09/72→07/84	9
Terrier TR650	01/70→12/72	8
Terrier TR650	08/70→09/72	13
Terrier TR650	01/72→12/84	15
Terrier TR738	01/70→12/72	8
Terrier TR738	01/72→12/84	15
Terrier TR750	01/70→12/72	8
Terrier TR750	08/70→09/72	13
Terrier TR750	01/72→12/84	15
Terrier TR850	01/70→12/72	16
Terrier TR850	08/70→09/72	13
Terrier TR850	01/72→12/84	15
Terrier TR950	01/70→12/72	16
Terrier TR950	08/70→09/72	13
Terrier TR950	01/72→12/84	15
Tiger	01/84→	29
Tiger Cub	01/62→12/70	22
Tiger Cub	01/80→	15
Titan	01/82→12/90	29
Tractor Unit CH17	01/69→08/72	18
Tractor Unit CH53	01/69→08/72	18
Tractor 3/42	01/61→12/64	2
Tractor 3/45	01/67→12/69	2
Tractor 4/60	01/62→12/64	6
Tractor 4/65	01/62→	7
Tractor 10/42	01/64→12/67	2
Tractor 10/60	01/64→12/67	6
Tractor 253		1
Tractor 255	01/74→12/76	10
Tractor 255	01/74→12/76	11
Tractor 262	01/77→12/81	10
Tractor 262	01/77→12/81	11
Tractor 270	01/74→12/76	10
Tractor 270	01/74→12/76	11
Tractor 272	01/77→12/81	10
Tractor 272	01/77→12/81	11
Tractor 285	01/76→12/81	14
Tractor 384	01/70→12/73	7
Tractor 485	01/73→12/81	14
Tractor 502		1
Tractor 602	01/81→	10



21 9

Tractor 602	01/81→	11
Tractor 604	01/81→	10
Tractor 604	01/81→	11
Tractor 702	01/81→	10
Tractor 702	01/81→	11
Tractor 704	01/81→	10
Tractor 704	01/81→	11
Tractor 802	01/81→	12
Tractor 804	01/81→	12
Tractor 904	01/85→	12
Tractor 2100	01/76→12/81	14
Tractor 4100	01/76→12/81	14
Tractor DM3V	01/54→12/58	3
Tractor DM4	01/54→12/61	3
Viking	01/63→12/72	22
Viking (VK43L)	01/60→12/69	22
Warrior	01/58→12/66	22
Worldmaster	01/54→12/79	28



cc



kW/PS

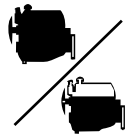

1	AD3.152	2500	3	91.49	Direct Injection		AG130	CG131 ■	EE205 ■
2	2.8T/TD	2827	3	100.00			AG240	CG240 ■	
3	3.4T/TA	3400	4	95.00			AG250	CG250 ■	EG251
4	3.5L Carburettor	3528	8	88.86	V8		AB5480 (x2) [21] AG910 (x2) [61]	CG913 ■	EG914
5	3.5V8	3528	8	88.86	V8		AB5480 (x2) [21] AG910 (x2) [61]	CG914 ■	EG914
6	38T/TA	3770	4	100.00			AG250	CG250 ■ Eng.80180 →	EG251
7	38TD	3770	4	100.00			AG250 →Eng.40898	CG252 ■ →Eng.40898	EG251
8	38VD	3770	4	100.00			AG250 01/67 →12/70 →Eng.28736 AH720 01/71 →12/72 Eng.28737 →	CG252 ■ 01/67 →12/70 →Eng.28736 CH720 ■ 01/71 →12/72 Eng.28737 →	EG251
9	4/98 NV	3770	4	98.00	Turbo		AH720	CH720 ■	EG251
10	4/98DT	3770	4	98.00	Turbo		AH720	CH720 ■	EG251
11	4/98NT	3770	4	98.00	Turbo		AH720	CH720 ■	EG251
12	4/98TT	3770	4	98.00	Turbo		AH720		EG251
13	51UD	5103	6	95.00			AG270 01/68 →12/69 →Eng.2402 AH730 01/70 →12/72 Eng.2403 →	CH731 ■ 01/70 →12/72 Eng.2403 →	
14	6/98 DT/NT	5650	6	98.00			AH730	CH731 ■	EG270
15	6/98 DV/NV	5650	6	98.00			AH730	CH731 ■	EG270
16	57J/57JC/57VD	5655	6	100.00			AG270 01/66 →12/70 →Eng.14964 AH730 01/71 →12/72 Eng.14965 →	CH731 ■ 01/70 →12/72 Eng.14965 →	EG270 01/66 →12/70 →Eng.14964
17	6.354.4	5800	6	98.47			BN370	DN376 ■	EH305 [62]

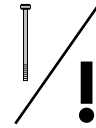
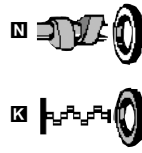
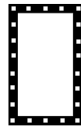
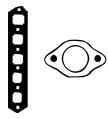

AB5480



AG130



AG240



AG250



AG270



AG910



AH720



AH730



BN370



JB792



JB894



JE289

			HR636	<input checked="" type="checkbox"/> NA736 57.15x76.2x12.7mm <input checked="" type="checkbox"/> KT633 [17] <input checked="" type="checkbox"/> NB460 [63] 133.4x158.8x12.7mm, SIL	
JE289				<input checked="" type="checkbox"/> NA933 127x146.1x11.1mm, ACM <input checked="" type="checkbox"/> NA773 55.6x73x12.7mm, NBR 01/67→	
		JJ106		<input checked="" type="checkbox"/> NA933 127x146.1x11.1mm, ACM	HT024 (x4) [21] [14]
JB894 JB792 (x8)	JM483 (x2)	JH434	HR5052	<input checked="" type="checkbox"/> NB849 48.7x63.5x8mm, FPM <input checked="" type="checkbox"/> NB291 82.6x98.7x12.7mm, MVQ	
JB894 JE289	JM483 (x2)	JH434	HR5052	<input checked="" type="checkbox"/> NB849 48.7x63.5x8mm, FPM <input checked="" type="checkbox"/> NB291 82.6x98.7x12.7mm, MVQ	
JE289				<input checked="" type="checkbox"/> NA933 127x146.1x11.1mm, ACM <input checked="" type="checkbox"/> NA581 52x68x10mm, MVQ 01/50→12/67 →Eng.80180 <input checked="" type="checkbox"/> NA773 55.6x73x12.7mm, NBR 01/67→12/70 Eng.80181→	HT024 (x4) [21] [14]
JE289		JJ106		<input checked="" type="checkbox"/> NA773 55.6x73x12.7mm, NBR <input checked="" type="checkbox"/> NA933 127x146.1x11.1mm, ACM	
JE289		JJ106		<input checked="" type="checkbox"/> NA773 55.6x73x12.7mm, NBR <input checked="" type="checkbox"/> NA933 127x146.1x11.1mm, ACM	
JE289		JJ106		<input checked="" type="checkbox"/> NA773 55.6x73x12.7mm, NBR <input checked="" type="checkbox"/> NA933 127x146.1x11.1mm, ACM	HT023 (x4) [21] [14]
JE289		JJ106		<input checked="" type="checkbox"/> NA773 55.6x73x12.7mm, NBR <input checked="" type="checkbox"/> NA933 127x146.1x11.1mm, ACM	HT023 (x4) [21] [14]
		JJ106		<input checked="" type="checkbox"/> NA773 55.6x73x12.7mm, NBR <input checked="" type="checkbox"/> NA933 127x146.1x11.1mm, ACM	HT023 (x4) [21] [14]
				<input checked="" type="checkbox"/> NA773 55.6x73x12.7mm, NBR <input checked="" type="checkbox"/> NA933 127x146.1x11.1mm, ACM	HT024 (x6) [21] [14]
				<input checked="" type="checkbox"/> NA773 55.6x73x12.7mm, NBR <input checked="" type="checkbox"/> NA933 127x146.1x11.1mm, ACM	HT023 (x6) [21] [14]
				<input checked="" type="checkbox"/> NA773 55.6x73x12.7mm, NBR <input checked="" type="checkbox"/> NA933 127x146.1x11.1mm, ACM	HT023 (x6) [21] [14]
				<input checked="" type="checkbox"/> NA773 55.6x73x12.7mm, NBR <input checked="" type="checkbox"/> NA933 127x146.1x11.1mm, ACM	
	JN215	JH443	HR638 (x2)	<input checked="" type="checkbox"/> NB459 60.33x79.37x9.52mm, SIL <input checked="" type="checkbox"/> NB460 [63] 133.4x158.8x12.7mm, SIL	



cc



Ø





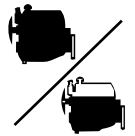





kW/PS



















18	0.401	6540	6	107.19	Turbo Vertical/Horizontal		AF140 [59][21] →Eng.7517685 BD380 [59] →Eng.7517685 BD390 [60] Eng.7517686→	DD380 [59] →Eng.7517685 DD390 [60] Eng.7517686→	FF140 [21][59] →Eng.7517685 GD380 [59] →Eng.7517685 GD390 [60] Eng.7517686→
19	0.401	6540	6	107.19	Turbo Vertical		BD390 [60]	DD390 [60]	GD390 [60]
20	0.410	6540	6	107.22	Turbo		AF140 [59][21] →Eng.7517685 BD380 [59] →Eng.7517685 BD390 [60] Eng.7517686→	DD380 [59] →Eng.7517685 DD390 [60] Eng.7517686→	FF140 [21][59] →Eng.7517685 GD380 [59] →Eng.7517685 GD390 [60] Eng.7517686→
21	411/420	6540	6	107.22	Turbo Vertical		BD390 [60]	DD390 [60]	GD390 [60]
22	0.400 P.P.MkI/II	6540	6	107.19	Direct Injection Vertical/Horizontal		AF140 [59][21] →Eng.7517685 BD380 [59] →Eng.7517685 BD390 [60] Eng.7517686→	DD380 [59][274] →Eng.7517685 DD390 [60] Eng.7517686→	FF140 [21][59] →Eng.7517685 GD380 [59] →Eng.7517685 GD390 [60] Eng.7517686→
23	V8.540	8830	8	107.95	Direct Injection		BS250 (x2)		
24	0.680/4000/8/9/11	11100	6	127.01			BJ180 (x2)	DJ180 [■]	
25	0.680/4001/7/10	11100	6	127.01			BJ180 (x2)	DJ180 [■]	
26	0.680/4002/3/4	11100	6	127.01			BJ180 (x2)	DJ180 [■]	
27	0.690	11100	6	127.01	Turbo, RH Engines Only		BJ030 (x2)	DJ030 [■]	EG965 [64] GJ030 [62] GJ031 [64]
28	0.680 P.P.MK3	11100	6	127.01	Direct Injection, RH Engine Only		BJ030 (x2)	DJ030 [■]	EG965 [64] GJ030 [62] GJ031 [64]
29	TL11	11100	6	130.00	Turbo		BJ180 (x2) →Eng.8261177 BN650 (x2) Eng.8261178→	DJ181 [■] →Eng.8261177 DN650 [■] Eng.8261178→	EG961 [64]
30	KT191	11630	6	130.00	Direct Injection, Turbo, Intercooled		BW470 (x2)	DW470 [■]○	

	JM389 [62]	JH226				AF140	JM268
	JM389	JH226				BD380	JM389
	JM389	JH226				BD390	JN530
	JM389	JH226				BJ030	JN943
	JM389	JH226				BJ180	
	JM389 [62]	JH226 [62]				BN650	
			HR639 [5] (x2)	[K] NB459 [5] 60.33x79.37x9.52mm, SIL [K] NB460 [5] 133.4x158.8x12.7mm, SIL		BS250	
JA721 [1] (x2) JA722 [5] (x2)	JM268 (x2)	JH223				BW470	
JA721 [1] (x2) JA722 [5] (x2)	JM268 (x2)					JA721	
JA721 [1] (x2) JA722 [5] (x2)	JM268 (x2)	JH223				JA722	
JA721 [1] (x2) JA722 [5] (x2)	JM268 (x2)	JH223				JH226	
JA721 [1] (x2) JA722 [5] (x2)	JN530 (x2)	JH223 [64]					
	JN943	JJ524					

		cc			9			cc			9
D 0224 M	Diesel	3790	4	102.00	1	D 0826 LE 521	Diesel	6871	6	108.00	18
D 0224 ME	Diesel	3790	4	102.00	1	D 0826 LE 522	Diesel	6871	6	108.00	18
D 0224 MF	Diesel	3790	4	102.00	1	D 0826 LE 523	Diesel	6871	6	108.00	18
D 0226 M	Diesel	5687	6	102.00	7	D 0826 LE 524	Diesel	6871	6	108.00	18
D 0226 MC	Diesel	5687	6	102.00	7	D 0826 LE 527	Diesel	6871	6	108.00	18
D 0226 MCF0/170	Diesel	5687	6	102.00	8	D 0826 LE 530	Diesel	6871	6	108.00	18
D 0226 ME	Diesel	5687	6	102.00	7	D 0826 LE51	Diesel	6871	6	108.00	16
D 0226 MF	Diesel	5687	6	102.00	7	D 0826 LE52	Diesel	6871	6	108.00	16
D 0226 MFA	Diesel	5687	6	102.00	7	D 0826 LF/217/Silent	Diesel	6870	6	108.00	14
D 0226 MFM	Diesel	5687	6	102.00	7	D 0826 LF01	Diesel	6871	6	108.00	16
D 0226 MFO	Diesel	5687	6	102.00	7	D 0826 LF02	Diesel	6871	6	108.00	16
D 0226 MH	Diesel	5687	6	102.00	7	D 0826 LF04	Diesel	6871	6	108.00	16
D 0226 MK	Diesel	5687	6	102.00	7	D 0826 LF05	Diesel	6871	6	108.00	16
D 0226 MKF	Diesel	5687	6	102.00	9	D 0826 LF06	Diesel	6871	6	108.00	16
D 0226 MKF/170	Diesel	5687	6	102.00	9	D 0826 LF07	Diesel	6871	6	108.00	16
D 0226 MKFA	Diesel	5687	6	102.00	7	D 0826 LF08	Diesel	6871	6	108.00	16
D 0226 MKFO	Diesel	5687	6	102.00	7	D 0826 LF09	Diesel	6871	6	108.00	16
D 0226 MKH	Diesel	5687	6	102.00	7	D 0826 LF10	Diesel	6871	6	108.00	16
D 0226 ML	Diesel	5687	6	102.00	7	D 0826 LF11	Diesel	6871	6	108.00	16
D 0226 MLE	Diesel	5687	6	102.00	7	D 0826 LF12	Diesel	6871	6	108.00	16
D 0226 MT	Diesel	5687	6	102.00	7	D 0826 LF13	Diesel	6871	6	108.00	16
D 0226 MTE	Diesel	5687	6	102.00	7	D 0826 LF15	Diesel	6871	6	108.00	16
D 0824 FL01	Diesel	4580	4	108.00	2	D 0826 LF17	Diesel	6871	6	108.00	16
D 0824 GF	Diesel	4580	4	108.00	3	D 0826 LF18	Diesel	6871	6	108.00	16
D 0824 GF01	Diesel	4580	4	108.00	3	D 0826 LFL	Diesel	6871	6	108.00	16
D 0824 GF02	Diesel	4580	4	108.00	3	D 0826 LFL02	Diesel	6871	6	108.00	19
D 0824 GF03	Diesel	4580	4	108.00	2	D 0826 LFL03	Diesel	6871	6	108.00	16
D 0824 GF04	Diesel	4580	4	108.00	2	D 0826 LFL05	Diesel	6871	6	108.00	16
D 0824 LF01	Diesel	4580	4	108.00	2	D 0826 LFL06	Diesel	6871	6	108.00	16
D 0824 LF02	Diesel	4580	4	108.00	2	D 0826 LFL07	Diesel	6871	6	108.00	16
D 0824 LF03	Diesel	4580	4	108.00	2	D 0826 LFL08	Diesel	6871	6	108.00	16
D 0824 LF04	Diesel	4580	4	108.00	2	D 0826 LFL09	Diesel	6871	6	108.00	16
D 0824 LF05	Diesel	4580	4	108.00	2	D 0826 LFL10	Diesel	6871	6	108.00	19
D 0824 LF06	Diesel	4580	4	108.00	2	D 0826 LOH01	Diesel	6871	6	108.00	16
D 0824 LF07	Diesel	4580	4	108.00	2	D 0826 LOH02	Diesel	6871	6	108.00	16
D 0824 LF08	Diesel	4580	4	108.00	2	D 0826 LOH03	Diesel	6871	6	108.00	21
D 0824 LF09	Diesel	4580	4	108.00	2	D 0826 LOH04	Diesel	6871	6	108.00	21
D 0824 LF10	Diesel	4580	4	108.00	2	D 0826 LOH05	Diesel	6871	6	108.00	16
D 0824 LFG 01	Diesel	4580	4	108.00	2	D 0826 LOH06	Diesel	6871	6	108.00	16
D 0824 LFL01	Diesel	4580	4	108.00	2	D 0826 LOH07	Diesel	6871	6	108.00	16
D 0824 LFL02	Diesel	4580	4	108.00	2	D 0826 LOH08	Diesel	6871	6	108.00	16
D 0824 LFL03	Diesel	4580	4	108.00	2	D 0826 LOH09	Diesel	6871	6	108.00	16
D 0824 LFL04	Diesel	4580	4	108.00	2	D 0826 LOH10	Diesel	6871	6	108.00	16
D 0824 LFL05	Diesel	4580	4	108.00	2	D 0826 LOH11	Diesel	6871	6	108.00	19
D 0824 LFL06	Diesel	4580	4	108.00	2	D 0826 LOH12	Diesel	6871	6	108.00	16
D 0824 LFL07	Diesel	4580	4	108.00	2	D 0826 LOH13	Diesel	6871	6	108.00	16
D 0824 LFL08	Diesel	4580	4	108.00	2	D 0826 LOH15	Diesel	6871	6	108.00	16
D 0824 LFL09	Diesel	4580	4	108.00	2	D 0826 LOH17	Diesel	6871	6	108.00	19
D 0824 LFL10	Diesel	4580	4	108.00	2	D 0826 LOH18	Diesel	6871	6	108.00	16
D 0824 LFO	Diesel	4580	4	108.00	4	D 0826 LOH19	Diesel	6871	6	108.00	16
D 0824 LFO 01	Diesel	4580	4	108.00	2	D 0826 LUE51	Diesel	6870	6	108.00	13
D 0824 LFO02	Diesel	4580	4	108.00	2	D 0826 LUH	Diesel	6870	6	108.00	14
D 0824 LOH01	Diesel	4580	4	108.00	2	D 0826 LUH	Diesel	6871	6	108.00	16
D 0824 LOH02	Diesel	4580	4	108.00	2	D 0826 LUH01	Diesel	6871	6	108.00	16
D 0824 LOH03	Diesel	4580	4	108.00	2	D 0826 LUH02	Diesel	6871	6	108.00	16
D 0824 LOH04	Diesel	4580	4	108.00	2	D 0826 LUH03	Diesel	6871	6	108.00	16
D 0824 LOH05	Diesel	4580	4	108.00	2	D 0826 LUH04	Diesel	6871	6	108.00	16
D 0824 LUE 521	Diesel	4580	4	108.00	2	D 0826 LUH05	Diesel	6871	6	108.00	16
D 0824 LUE 522	Diesel	4580	4	108.00	2	D 0826 LUH06	Diesel	6871	6	108.00	16
D 0824 LUE 523	Diesel	4580	4	108.00	2	D 0826 LUH08	Diesel	6871	6	108.00	16
D 0826	Diesel	6867	6	108.00	12	D 0826 LUH09	Diesel	6871	6	108.00	17
D 0826	Diesel	6871	6	108.00	17	D 0826 LUH10	Diesel	6871	6	108.00	16
D 0826 F01	Diesel	6871	6	108.00	17	D 0826 LUH11	Diesel	6871	6	108.00	17
D 0826 F02	Diesel	6871	6	108.00	17	D 0826 LUH12	Diesel	6870	6	108.00	15
D 0826 FG001	Diesel	6871	6	108.00	16	D 0826 LUH13	Diesel	6871	6	108.00	16
D 0826 FO 01	Diesel	6871	6	108.00	17	D 0826 OH	Diesel	6871	6	108.00	16
D 0826 FO 02	Diesel	6871	6	108.00	17	D 0826 OH01	Diesel	6871	6	108.00	16
D 0826 GF	Diesel	6871	6	108.00	17	D 0826 OH02	Diesel	6871	6	108.00	17
D 0826 GF01	Diesel	6871	6	108.00	17	D 0826 OH03	Diesel	6871	6	108.00	16
D 0826 GF02	Diesel	6871	6	108.00	20	D 0826 TF	Diesel	6596	6	108.00	11
D 0826 GF03	Diesel	6871	6	108.00	16	D 0826 TOH	Diesel	6596	6	108.00	11
D 0826 GF04	Diesel	6871	6	108.00	16	D 0826 TOH 01	Diesel	6596	6	108.00	10
D 0826 GFA	Diesel	6871	6	108.00	18	D 0826 TUE 51	Diesel	6871	6	108.00	16

		CC			9			CC			9
D 0834 LFL01	Diesel	4580	4	108.00	2	D 2146 HM	Diesel	9660	6	121.00	29
D 0834 LFL02	Diesel	4580	4	108.00	2	D 2146 HM1	Diesel	9660	6	121.00	29
D 0834 LFL03	Diesel	4580	4	108.00	2	D 2146 HM1U	Diesel	9660	6	121.00	29
D 0834 LFL04	Diesel	4581	4	108.00	5	D 2146 HMN	Diesel	9660	6	121.00	29
D 0834 LFL20	Diesel	4580	4	108.00	2	D 2146 M1	Diesel	9660	6	121.00	29
D 0834 LFL40	Diesel	4581	4	108.00	6	D 2146 M11	Diesel	9660	6	121.00	29
D 0834 LFL41	Diesel	4581	4	108.00	6	D 2146 M14	Diesel	9660	6	121.00	29
D 0834 LFL42	Diesel	4581	4	108.00	6	D 2146 M9	Diesel	9660	6	121.00	29
D 0834 LFL50	Diesel	4581	4	108.00	6	D 2146 MN	Diesel	9660	6	121.00	29
D 0834 LFL51	Diesel	4581	4	108.00	6	D 2146 MN11	Diesel	9660	6	121.00	29
D 0834 LFL52	Diesel	4581	4	108.00	6	D 2146 MT1	Diesel	9660	6	121.00	29
D 0834 LFL53	Diesel	4581	4	108.00	6	D 2146 MT1F	Diesel	9660	6	121.00	29
D 0834 LFL54	Diesel	4581	4	108.00	6	D 2156 HM 2	Diesel	10344	6	121.00	33
D 0834 LFL55	Diesel	4581	4	108.00	6	D 2156 HM1U	Diesel	10344	6	121.00	33
D 0834 LOH01	Diesel	4580	4	108.00	2	D 2156 HM3	Diesel	10344	6	121.00	33
D 0834 LOH02	Diesel	4580	4	108.00	2	D 2156 HM51U	Diesel	10344	6	121.00	33
D 0834 LOH03	Diesel	4580	4	108.00	2	D 2156 HM52U	Diesel	10344	6	121.00	33
D 0834 LOH50	Diesel	4581	4	108.00	6	D 2156 HM5U	Diesel	10344	6	121.00	33
D 0834 LOH51	Diesel	4581	4	108.00	6	D 2156 HM6H	Diesel	10344	6	121.00	33
D 0834 LOH52	Diesel	4581	4	108.00	6	D 2156 HM6HDK	Diesel	10344	6	121.00	33
D 0834 LOH53	Diesel	4581	4	108.00	6	D 2156 HM9	Diesel	10344	6	121.00	33
D 0836 HM3U	Diesel	7030	6	108.00	23	D 2156 HMN1	Diesel	10344	6	121.00	33
D 0836 HM4	Diesel	7030	6	108.00	24	D 2156 HMN-5	Diesel	10344	6	121.00	33
D 0836 HM5U	Diesel	7030	6	108.00	23	D 2156 HMN6	Diesel	10344	6	121.00	33
D 0836 HM7	Diesel	7030	6	108.00	24	D 2156 HMX-032	Diesel	10344	6	121.00	33
D 0836 HM70	Diesel	7030	6	108.00	24	D 2156 HMXU-037	Diesel	10344	6	121.00	33
D 0836 HM71	Diesel	7030	6	108.00	24	D 2156 HMXU-038	Diesel	10344	6	121.00	33
D 0836 HM7U	Diesel	7030	6	108.00	24	D 2156 HNY	Diesel	10344	6	121.00	33
D 0836 HM8U	Diesel	7030	6	108.00	23	D 2156 MGN	Diesel	10344	6	121.00	33
D 0836 HM9H	Diesel	7030	6	108.00	24	D 2156 MNY	Diesel	10344	6	121.00	33
D 0836 HM9U	Diesel	7030	6	108.00	24	D 2156 MTN1	Diesel	10344	6	121.00	33
D 0836 HMN70	Diesel	7030	6	108.00	24	D 2156 MTN5	Diesel	10344	6	121.00	33
D 0836 LFO1	Diesel	6871	6	108.00	19	D 2156 MTX	Diesel	10344	6	121.00	33
D 0836 LFO2	Diesel	6871	6	108.00	19	D 2156 MTX-034	Diesel	10344	6	121.00	33
D 0836 LFO3	Diesel	6871	6	108.00	19	D 2156 MTXN-035	Diesel	10344	6	121.00	33
D 0836 LFO4	Diesel	6871	6	108.00	19	D 2156 MY	Diesel	10344	6	121.00	33
D 0836 LFO5	Diesel	6871	6	108.00	19	D 2156 MY-30	Diesel	10344	6	121.00	33
D 0836 LFA1	Diesel	6871	6	108.00	22	D 2156 MYN	Diesel	10344	6	121.00	33
D 0836 LFA4	Diesel	6871	6	108.00	22	D 2156 MYN-31	Diesel	10344	6	121.00	33
D 0836 LFL01	Diesel	6871	6	108.00	19	D 2530 ME	Diesel	15945	10	125.00	55
D 0836 LFL02	Diesel	6871	6	108.00	19	D 2530 MF	Diesel	15945	10	125.00	56
D 0836 LFL03	Diesel	6871	6	108.00	19	D 2530 MTE	Diesel	15953	10	125.00	58
D 0836 LFL04	Diesel	6871	6	108.00	19	D 2530 MTXF	Diesel	15953	10	125.00	58
D 0836 LFL05	Diesel	6871	6	108.00	19	D 2530 MTXF/360	Diesel	15900	10	125.00	54
D 0836 LFL06	Diesel	6871	6	108.00	16	D 2530 MXF	Diesel	15945	10	125.00	55
D 0836 LFL07	Diesel	6871	6	108.00	16	D 2530 MXFR/D 2530 MXH	Diesel	15953	10	125.00	57
D 0836 LFL10	Diesel	6871	6	108.00	16	D 2538 M	Diesel	12763	8	125.00	49
D 0836 LFL40	Diesel	6871	6	108.00	22	D 2538 ME	Diesel	12763	8	125.00	49
D 0836 LFL41	Diesel	6871	6	108.00	22	D 2538 MF	Diesel	12763	8	125.00	49
D 0836 LFL44	Diesel	6871	6	108.00	22	D 2538 MT	Diesel	12763	8	125.00	49
D 0836 LFL50	Diesel	6871	6	108.00	22	D 2538 MTE	Diesel	12763	8	125.00	49
D 0836 LFL51	Diesel	6871	6	108.00	22	D 2540 MT	Diesel	17426	10	125.00	59
D 0836 LFL52	Diesel	6871	6	108.00	22	D 2540 MTF	Diesel	17426	10	125.00	59
D 0836 LFL53	Diesel	6871	6	108.00	22	D 2540 MTF/390	Diesel	17426	10	125.00	59
D 0836 LFL54	Diesel	6871	6	108.00	22	D 2542 ME	Diesel	20911	12	125.00	62
D 0836 LFL55	Diesel	6871	6	108.00	22	D 2542 MLE	Diesel	20911	12	125.00	63
D 0836 LOH 63	Diesel	6871	6	108.00	22	D 2542 MTE	Diesel	20911	12	125.00	63
D 0836 LOH01	Diesel	6871	6	108.00	19	D 2555 M	Diesel	9200	5	125.00	27
D 0836 LOH02	Diesel	6871	6	108.00	19	D 2555 MF	Diesel	9200	5	125.00	27
D 0836 LOH03	Diesel	6871	6	108.00	19	D 2555 MX	Diesel	9200	5	125.00	27
D 0836 LOH40	Diesel	6871	6	108.00	22	D 2555 MXF	Diesel	9200	5	125.00	27
D 0836 LOH41	Diesel	6871	6	108.00	22	D 2555 MXUL	Diesel	9200	5	125.00	27
D 0836 LOH51	Diesel	6871	6	108.00	22	D 2556 M	Diesel	11045	6	125.00	35
D 0836 LOH52	Diesel	6871	6	108.00	22	D 2556 MF	Diesel	11045	6	125.00	35
D 0836 LOH55	Diesel	6871	6	108.00	22	D 2556 MTE	Diesel	11045	6	125.00	34
D 0836 LOH56	Diesel	6871	6	108.00	22	D 2556 MX	Diesel	11045	6	125.00	35
D 0836 LOH62	Diesel	6871	6	108.00	22	D 2556 MXF	Diesel	11045	6	125.00	35
D 0836 LUH01	Diesel	6871	6	108.00	19	D 2556 MXUH/175	Diesel	11045	6	125.00	34
D 0836 LUH02	Diesel	6871	6	108.00	19	D 2556 MXUH/192	Diesel	11045	6	125.00	34
D 0836 LUH40	Diesel	6871	6	108.00	22	D 2556 MXUH/240	Diesel	11045	6	125.00	34
D 0836 LUH41	Diesel	6871	6	108.00	22	D 2556 MXUM	Diesel	11045	6	125.00	34
D 0846 HM2	Diesel	7250	6	108.00	25	D 2565 HM	Diesel	9510	5	125.00	28
D 0846 HMN	Diesel	7252	6	108.00	26	D 2565 M	Diesel	9510	5	125.00	28

		cc			9			cc			9
D 2565 M/168	Diesel	9510	5	125.00	28	D 2842 LXE	Diesel	21927	12	128.00	65
D 2565 ME	Diesel	9510	5	125.00	28	D 2842 LYE	Diesel	21927	12	128.00	65
D 2565 MF	Diesel	9510	5	125.00	28	D 2842 LZE	Diesel	21927	12	128.00	65
D 2565 MF/168	Diesel	9510	5	125.00	28	D 2842 ME	Diesel	21927	12	128.00	65
D 2565 MFR	Diesel	9510	5	125.00	28	D 2848 LXE	Diesel	14618	8	128.00	53
D 2565 MH	Diesel	9510	5	125.00	28	D 2848 LYE	Diesel	14618	8	128.00	53
D 2565 MK	Diesel	9510	5	125.00	28	D 2848 M	Diesel	14618	8	128.00	53
D 2565 MKUL	Diesel	9510	5	125.00	28	D 2848 MH	Diesel	14618	8	128.00	53
D 2565 MR	Diesel	9510	5	125.00	28	D 2865 LF/260	Diesel	9973	5	128.00	30
D 2565 MSFV	Diesel	9510	5	125.00	28	D 2865 LF02	Diesel	9973	5	128.00	31
D 2565 MT	Diesel	9510	5	125.00	28	D 2865 LF03	Diesel	9973	5	128.00	32
D 2565 MUE	Diesel	9510	5	125.00	28	D 2865 LF05	Diesel	9973	5	128.00	32
D 2565 MUH	Diesel	9510	5	125.00	28	D 2865 LF06	Diesel	9973	5	128.00	32
D 2565 MUL	Diesel	9510	5	125.00	28	D 2865 LF09	Diesel	9973	5	128.00	32
D 2566	Diesel	11413	6	125.00	36	D 2865 LF20	Diesel	9973	5	128.00	32
D 2566 M	Diesel	11413	6	125.00	37	D 2865 LF21	Diesel	9973	5	128.00	32
D 2566 ME	Diesel	11413	6	125.00	36	D 2865 LF22	Diesel	9973	5	128.00	32
D 2566 MF	Diesel	11413	6	125.00	37	D 2865 LF23	Diesel	9973	5	128.00	32
D 2566 MF/220	Diesel	11413	6	125.00	36	D 2865 LF24	Diesel	9973	5	128.00	32
D 2566 MH	Diesel	11413	6	125.00	37	D 2865 LFH01	Diesel	9973	5	128.00	30
D 2566 MHO	Diesel	11413	6	125.00	37	D 2865 LOH02	Diesel	9973	5	128.00	30
D 2566 MK	Diesel	11413	6	125.00	36	D 2865 LU01/Silent	Diesel	9973	5	128.00	32
D 2566 MK/280	Diesel	11413	6	125.00	36	D 2865 LU05	Diesel	9973	5	128.00	32
D 2566 MKF	Diesel	11413	6	125.00	36	D 2865 LUH02	Diesel	9973	5	128.00	30
D 2566 MKF/280	Diesel	11413	6	125.00	36	D 2865 LUH05	Diesel	9973	5	128.00	30
D 2566 MKUH/320	Diesel	11413	6	125.00	36	D 2865 LUH07	Diesel	9973	5	128.00	30
D 2566 MKUL	Diesel	11413	6	125.00	36	D 2865 LUH08	Diesel	9973	5	128.00	30
D 2566 MLUH	Diesel	11413	6	125.00	36	D 2865 LUH09	Diesel	9973	5	128.00	30
D 2566 MLUM	Diesel	11413	6	125.00	36	D 2866 F/240	Diesel	11967	6	128.00	38
D 2566 MLUM/US	Diesel	11413	6	125.00	36	D 2866 FR	Diesel	11967	6	128.00	38
D 2566 MSFV	Diesel	11413	6	125.00	36	D 2866 KF	Diesel	11967	6	128.00	46
D 2566 MT	Diesel	11413	6	125.00	36	D 2866 KFZ	Diesel	11967	6	128.00	46
D 2566 MTE	Diesel	11413	6	125.00	36	D 2866 KOH/360	Diesel	11967	6	128.00	41
D 2566 MTF	Diesel	11413	6	125.00	36	D 2866 KOH/373	Diesel	11967	6	128.00	42
D 2566 MTFG	Diesel	11413	6	125.00	36	D 2866 KUH/360	Diesel	11967	6	128.00	41
D 2566 MTH	Diesel	11413	6	125.00	36	D 2866 KUL	Diesel	11967	6	128.00	41
D 2566 MTHO	Diesel	11413	6	125.00	36	D 2866 LF/290	Diesel	11967	6	128.00	41
D 2566 MTSF	Diesel	11413	6	125.00	36	D 2866 LF/330	Diesel	11967	6	128.00	41
D 2566 MTUH/280	Diesel	11413	6	125.00	36	D 2866 LF03	Diesel	11967	6	128.00	42
D 2566 MUE	Diesel	11413	6	125.00	36	D 2866 LF04	Diesel	11967	6	128.00	42
D 2566 MUH	Diesel	11413	6	125.00	36	D 2866 LF05	Diesel	11967	6	128.00	42
D 2566 MUH/175	Diesel	11413	6	125.00	36	D 2866 LF06	Diesel	11967	6	128.00	42
D 2566 MUH/192	Diesel	11413	6	125.00	36	D 2866 LF09	Diesel	11967	6	128.00	42
D 2566 MUH/200	Diesel	11413	6	125.00	36	D 2866 LF10	Diesel	11967	6	128.00	42
D 2566 MUH/220	Diesel	11413	6	125.00	36	D 2866 LF14	Diesel	11967	6	128.00	38
D 2566 MUH/240	Diesel	11413	6	125.00	36	D 2866 LF15	Diesel	11967	6	128.00	46
D 2566 MUL	Diesel	11413	6	125.00	36	D 2866 LF16	Diesel	11967	6	128.00	42
D 2566 MUM	Diesel	11413	6	125.00	36	D 2866 LF20	Diesel	11967	6	128.00	44
D 2566 MUM/200	Diesel	11413	6	125.00	36	D 2866 LF21	Diesel	11967	6	128.00	44
D 2566 MUM/220	Diesel	11413	6	125.00	36	D 2866 LF22	Diesel	11967	6	128.00	44
D 2566 MUM/240	Diesel	11413	6	125.00	36	D 2866 LF23	Diesel	11967	6	128.00	43
D 2566 MXF	Diesel	11413	6	125.00	36	D 2866 LF24	Diesel	11967	6	128.00	43
D 2566 UH	Diesel	11413	6	125.00	36	D 2866 LF25	Diesel	11967	6	128.00	43
D 2566 UH/205	Diesel	11413	6	125.00	36	D 2866 LF26	Diesel	11967	6	128.00	43
D 2840 LE	Diesel	18273	10	128.00	60	D 2866 LF27	Diesel	11967	6	128.00	43
D 2840 LF/460	Diesel	18273	10	128.00	60	D 2866 LF28	Diesel	11967	6	128.00	43
D 2840 LF01	Diesel	18273	10	128.00	60	D 2866 LF29	Diesel	11967	6	128.00	43
D 2840 LF04	Diesel	18273	10	128.00	60	D 2866 LF30	Diesel	11967	6	128.00	43
D 2840 LF06	Diesel	18273	10	128.00	60	D 2866 LF31	Diesel	11967	6	128.00	43
D 2840 LF20	Diesel	18273	10	128.00	60	D 2866 LF32	Diesel	11967	6	128.00	43
D 2840 LF21	Diesel	18273	10	128.00	60	D 2866 LF34	Diesel	11967	6	128.00	44
D 2840 LF25	Diesel	18273	10	128.00	60	D 2866 LF35	Diesel	11967	6	128.00	44
D 2840 LXE	Diesel	18273	10	128.00	60	D 2866 LF36	Diesel	11967	6	128.00	43
D 2840 LXF	Diesel	18273	10	128.00	60	D 2866 LF37	Diesel	11967	6	128.00	43
D 2840 LYE	Diesel	18273	10	128.00	60	D 2866 LFZ/290	Diesel	11967	6	128.00	41
D 2840 ME	Diesel	18273	10	128.00	60	D 2866 LFZ/330	Diesel	11967	6	128.00	38
D 2840 MF	Diesel	18273	10	128.00	60	D 2866 LOH	Diesel	11967	6	128.00	38
D 2840 MFG	Diesel	18273	10	128.00	60	D 2866 LOH03	Diesel	11967	6	128.00	38
D 2840 MFR	Diesel	18273	10	128.00	60	D 2866 LOH06	Diesel	11967	6	128.00	38
D 2840 MH	Diesel	18273	10	128.00	60	D 2866 LOH07	Diesel	11967	6	128.00	38
D 2840 TL	Diesel	18273	10	128.00	61	D 2866 LOH20	Diesel	11967	6	128.00	38
D 2842 LE622	Diesel	21927	12	128.00	64	D 2866 LOH22	Diesel	11967	6	128.00	38
D 2842 LF10	Diesel	21927	12	128.00	65	D 2866 LOH23	Diesel	11967	6	128.00	38

		CC			9			CC			9
D 2866 LOH24	Diesel	11970	6	128.00	48						
D 2866 LOH25	Diesel	11967	6	128.00	38						
D 2866 LOH26	Diesel	11967	6	128.00	38						
D 2866 LOH27	Diesel	11967	6	128.00	43						
D 2866 LOH28	Diesel	11967	6	128.00	43						
D 2866 LOH29	Diesel	11967	6	128.00	43						
D 2866 LOH32	Diesel	11967	6	128.00	43						
D 2866 LOH33	Diesel	11967	6	128.00	43						
D 2866 LOH34	Diesel	11967	6	128.00	43						
D 2866 LU/330	Diesel	11967	6	128.00	38						
D 2866 LUH/330	Diesel	11967	6	128.00	38						
D 2866 LUH20	Diesel	11967	6	128.00	38						
D 2866 LUH21	Diesel	11967	6	128.00	38						
D 2866 LUH22	Diesel	11967	6	128.00	38						
D 2866 LUH23	Diesel	11967	6	128.00	40						
D 2866 LUH24	Diesel	11967	6	128.00	43						
D 2866 LUH25	Diesel	11967	6	128.00	39						
D 2866 LUH26	Diesel	11967	6	128.00	38						
D 2866 LUH29	Diesel	11967	6	128.00	39						
D 2866 LUH30	Diesel	11967	6	128.00	43						
D 2866 LUL/330	Diesel	11967	6	128.00	46						
D 2866 LX	Diesel	11967	6	128.00	38						
D 2866 LXF	Diesel	11967	6	128.00	38						
D 2866 LXOH	Diesel	11967	6	128.00	38						
D 2866 T	Diesel	11967	6	128.00	42						
D 2866 TOH	Diesel	11967	6	128.00	38						
D 2866 TOH/290	Diesel	11967	6	128.00	42						
D 2866 TOH/310	Diesel	11967	6	128.00	42						
D 2866 TUH	Diesel	11967	6	128.00	38						
D 2866 TUH/290	Diesel	11967	6	128.00	38						
D 2866 TUH01	Diesel	11967	6	128.00	38						
D 2866 UH	Diesel	11967	6	128.00	38						
D 2866 UH/240	Diesel	11967	6	128.00	38						
D 2866 UM	Diesel	11967	6	128.00	38						
D 2876 LFO2	Diesel	12816	6	128.00	50						
D 2876 LFO3	Diesel	12816	6	128.00	51						
D 2876 LFO4	Diesel	12816	6	128.00	51						
D 2876 LFO5	Diesel	12816	6	128.00	51						
D 2876 LFO6	Diesel	12816	6	128.00	51						
D 2876 LFO7	Diesel	12816	6	128.00	51						
D 2876 LF11	Diesel	12816	6	128.00	51						
D 2876 LF12	Diesel	12816	6	128.00	52						
D 2876 LF13	Diesel	12816	6	128.00	52						
D 2876 LF25	Diesel	12816	6	128.00	52						
D 2876 LOH01	Diesel	12816	6	128.00	51						
D 2876 LOH02	Diesel	12816	6	128.00	51						
D 2876 LOH03	Diesel	12816	6	128.00	51						
D 2876 LOH20	Diesel	12816	6	128.00	52						
D 2876 LOH21	Diesel	12816	6	128.00	52						
E 2866	CNG	11967	6	128.00	39						
E 2866 DF01	CNG	11967	6	128.00	39						
E 2866 DF02	CNG	11967	6	128.00	39						
E 2866 DF03	CNG	11967	6	128.00	39						
E 2866 DF04	CNG	11967	6	128.00	39						
E 2866 DOH02	CNG	11967	6	128.00	39						
E 2866 DOH03	CNG	11967	6	128.00	39						
E 2866 DOH04	CNG	11967	6	128.00	39						
E 2866 DUH	CNG	11970	6	128.00	47						
E 2866 DUH01	CNG	11967	6	128.00	39						
E 2866 DUH03	CNG	11967	6	128.00	39						
E 2866 LUH02	CNG	11967	6	128.00	45						



21 9

E 2000 19.310 FALK	05/00→	43
E 2000 19.310 FALS	05/00→	43
E 2000 19.310 FLK	05/00→	43
E 2000 19.310 FLS	05/00→	43
E 2000 19.360 FALK	05/00→	43
E 2000 19.360 FALS	05/00→	43
E 2000 19.360 FLK	05/00→	43
E 2000 19.360 FLS	05/00→	43
E 2000 19.410 FALK	05/00→	43
E 2000 19.410 FALS	05/00→	43
E 2000 19.410 FLK	05/00→	43
E 2000 19.410 FLS	05/00→	43
E 2000 19.460 FALK	05/00→	51
E 2000 19.460 FALS	05/00→	51
E 2000 19.460 FLK	05/00→	51
E 2000 19.460 FLS	05/00→	51
E 2000 26.310 FAVLC	05/00→	43
E 2000 26.310 FAVLK	05/00→	43
E 2000 26.360 FAVLC	05/00→	43
E 2000 26.360 FAVLK	05/00→	43
E 2000 26.410 DFARC	05/00→	43
E 2000 26.410 DFRC, FAVLC	05/00→	43
E 2000 26.410 FAVLK	05/00→	43
E 2000 26.460 DFARC	05/00→	51
E 2000 26.460 DFALRS	05/00→	51
E 2000 26.460 FAVLC	05/00→	51
E 2000 26.460 FAVLK	05/00→	51
E 2000 28.230 FNLC	05/00→	39
E 2000 28.310 FNLC	05/00→	43
E 2000 28.360 FANLC	05/00→	43
E 2000 28.360 FANLK	05/00→	43
E 2000 28.360 FNALC	05/00→	43
E 2000 28.360 FNLC	05/00→	43
E 2000 28.410 FANLC	05/00→	43
E 2000 28.410 FANLK	05/00→	43
E 2000 28.410 FNLC	05/00→	43
E 2000 28.460 FANLC	05/00→	51
E 2000 28.460 FANLK	05/00→	51
E 2000 28.460 FNLC	05/00→	51
E 2000 29.460 FVAS	05/00→	51
E 2000 30.310 FNLC	05/00→	43
E 2000 30.360 FANLC	05/00→	43
E 2000 30.360 FANLK	05/00→	43
E 2000 30.360 FNLC	05/00→	43
E 2000 30.410 FANLC	05/00→	43
E 2000 30.410 FANLK	05/00→	43
E 2000 30.410 FNLC	05/00→	43
E 2000 30.460 FANLC	05/00→	51
E 2000 30.460 FANLK	05/00→	51
E 2000 30.460 FNLC	05/00→	51
E 2000 32.310 VFCL	05/00→	43
E 2000 32.310 VFNL	05/00→	43
E 2000 32.360 VFCL	05/00→	43
E 2000 32.360 VFNL	05/00→	43
E 2000 32.410 VFARK	05/00→	43
E 2000 32.410 VFCL, VFRC, VFRLC	05/00→	43
E 2000 32.410 VFNL	05/00→	43
E 2000 32.460 VFCL, VFRLC	05/00→	51
E 2000 32.460 VFNL	05/00→	51
E 2000 33.360 DFALK, DFALC	05/00→	43
E 2000 33.360 DFALS	04/01→	43
E 2000 33.360 DFCL	05/00→	43
E 2000 33.360 DFCL	05/00→	43
E 2000 33.360 DFSL	05/00→	43
E 2000 33.410 DFALK, DFALC	05/00→	43
E 2000 33.410 DFALS	04/01→	43
E 2000 33.410 DFCL	05/00→	43
E 2000 33.410 DFCL	05/00→	43
E 2000 33.410 DFSL	05/00→	43
E 2000 33.410 DFSL	05/00→	43
E 2000 33.460 DFALK, DFALC	05/00→	51
E 2000 33.460 DFALC	05/00→	51



21 9

E 2000 33.460 DFALS	04/01→	51
E 2000 33.460 DFCL	05/00→	51
E 2000 33.460 DFCL	05/00→	51
E 2000 33.460 DFSL	05/00→	51
E 2000 33.600 DFALS, DFAS	06/00→	60
E 2000 33.600 DFSL	06/00→	60
E 2000 35.360 VFAK	05/00→	43
E 2000 35.410 FVNLC	05/00→	43
E 2000 35.410 VFAK	05/00→	43
E 2000 35.460 FVNLC	05/00→	51
E 2000 35.460 VFAK	05/00→	51
E 2000 40.600 DFAS	06/00→	60
E 2000 41.360 VFAK	05/00→	43
E 2000 41.410 VFAK	05/00→	43
E 2000 41.460 DFVS, DFVLS	06/00→	51
E 2000 41.460 VFAK	05/00→	51
E 2000 41.600 DFVS, DFVLS	06/00→	60
E 2000 50.410 VFAK	05/00→	43
E 2000 50.410 VFAVK, VFAV-G	03/01→	43
E 2000 50.410 VFK	05/00→	43
E 2000 50.410 VFVK, VFV-G	10/00→	43
E 2000 50.460 VFAK	05/00→	51
E 2000 50.460 VFAVK, VFAV-G	03/01→	51
E 2000 50.460 VFK	05/00→	51
E 2000 50.460 VFVK, VFV-G	10/00→	51
E 2000 50.600 VFAS	05/00→	60
EL EL 202, EL 222	01/93→06/97	15
EL EL 202, EL 222	01/93→06/97	16
EL EL 202, EL 262	04/94→06/97	14
EL EL 262	07/98→	38
EM EM 192	10/93→06/97	16
EM EM 222, EM 223	02/96→	15
EM EM 222, EM 223	02/96→	16
EM EM 223	08/87→	16
F 9 15.192 F, 15.192 FL	01/83→12/86	28
F 9 15.192 FS	01/83→12/86	28
F 90 15.192 FL		29
F 90 19.242 F, 19.242 FL, 19.242 FLL	01/88→01/89	38
F 90 19.242 FK	01/88→02/89	38
F 90 19.242 FS, 19.242 FLS, 19.242 FLLS	01/88→01/89	38
F 90 19.262 F, 19.262 FL, 19.262 FLL	01/88→02/90	30
F 90 19.262 FA	02/89→02/90	30
F 90 19.262 FAK	02/89→02/90	30
F 90 19.262 FAS	02/89→02/90	30
F 90 19.262 FK	01/88→02/90	30
F 90 19.262 FS, 19.262 FLS, 19.262 FLLS	01/88→02/90	30
F 90 19.272 F, 19.272 FL, 19.272 FLL	02/90→05/95	31
F 90 19.272 F, 19.272 FL, 19.272 FLL	02/90→05/95	31
F 90 19.272 FA	02/90→05/95	32
F 90 19.272 FA	02/90→05/95	32
F 90 19.272 FAK	02/90→05/95	31
F 90 19.272 FAK	02/90→05/95	32
F 90 19.272 FAS	02/90→05/95	31
F 90 19.272 FAS	02/90→05/95	32
F 90 19.272 FK	02/90→05/95	31
F 90 19.272 FK	02/90→05/95	32
F 90 19.272 FS, 19.272 FLS, 19.272 FLLS	02/90→05/95	31
F 90 19.272 FS, 19.272 FLS, 19.272 FLLS	02/90→05/95	32
F 90 19.292 F, 19.292 FL, 19.292 FLL	07/86→02/90	41
F 90 19.292 FA	05/88→02/90	41
F 90 19.292 FAK	05/88→02/90	41
F 90 19.292 FAS	05/88→02/90	41
F 90 19.292 FK	07/86→02/90	41
F 90 19.292 FS, 19.292 FLS, 19.292 FLLS	07/86→02/90	41
F 90 19.322 F, 19.322 FL, 19.322 FLL	02/90→05/95	32
F 90 19.322 FA	02/90→06/96	32
F 90 19.322 FAK	02/90→06/96	32
F 90 19.322 FAS	02/90→06/96	32
F 90 19.322 FK	02/90→05/95	32
F 90 19.322 FS, 19.322 FLS, 19.322 FLLS	02/90→05/95	32
F 90 19.332 F, 19.332 FL, 19.332 FLL	07/86→02/90	41
F 90 19.332 FA	05/88→02/90	41
F 90 19.332 FAK	05/88→02/90	41



21

9



21

9

F 90 19.332 FAS	05/88→02/90	41	F 90 24.302 FNL,24.302 FNLL,24.302 FVL	05/90→10/90	42
F 90 19.332 FK	07/86→02/90	41	F 90 24.322 DF	02/90→12/90	32
F 90 19.332 FS,19.332 FLS,19.332 FLLS	07/86→02/90	41	F 90 24.322 DFK	02/90→12/90	32
F 90 19.342 F,19.342 FL,19.342 FLL	05/94→05/95	32	F 90 24.322 DFS,24.322 DFLS	02/90→12/90	32
F 90 19.342 FA	05/94→06/96	32	F 90 24.322 FNL,24.322 FNLL,24.322 FVL	10/86→05/95	32
F 90 19.342 FAK	05/94→06/96	32	F 90 24.322 FNLS,24.322 FVLS	02/90→05/95	32
F 90 19.342 FAS	05/94→06/96	32	F 90 24.332 DF	04/87→02/90	41
F 90 19.342 FK	05/94→05/95	32	F 90 24.332 DFK	04/87→02/90	41
F 90 19.342 FS,19.342 FLS,19.342 FLLS	05/94→05/95	32	F 90 24.332 DFS,24.332 DFLS	04/87→02/90	41
F 90 19.362 F,19.362 FL,19.362 FLL	07/86→02/90	38	F 90 24.332 FNL,24.332 FNLL,24.332 FVL	10/86→02/90	41
F 90 19.362 F,19.362 FL,19.362 FLL	07/86→02/90	46	F 90 24.332 FNLS,24.332 FVLS	10/86→02/90	41
F 90 19.362 FA	05/88→02/90	38	F 90 24.342 FNL,24.342 FNLL	05/94→05/95	32
F 90 19.362 FAK	05/88→02/90	38	F 90 24.362 DF	04/87→02/90	38
F 90 19.362 FAS	05/88→02/90	38	F 90 24.362 DF	04/87→02/90	38
F 90 19.362 FK	07/86→02/90	38	F 90 24.362 DFK	04/87→02/90	38
F 90 19.362 FK	07/86→02/90	46	F 90 24.362 DFK	04/87→02/90	46
F 90 19.362 FS,19.362 FLS,19.362 FLLS	07/86→02/90	38	F 90 24.362 DFS,24.362 DFLS	04/87→02/90	38
F 90 19.362 FS,19.362 FLS,19.362 FLLS	07/86→02/90	46	F 90 24.362 DFS,24.362 DFLS	04/87→02/90	46
F 90 19.372 F,19.372 FL,19.372 FLL	02/90→05/95	42	F 90 24.362 FNL,24.362 FNLL,24.362 FVL	10/86→02/90	38
F 90 19.372 F,19.372 FL,19.372 FLL	02/90→05/95	46	F 90 24.362 FNL,24.362 FNLL,24.362 FVL	10/86→02/90	46
F 90 19.372 F,19.372 FL,19.372 FLL	05/90→04/95	38	F 90 24.362 FNLS,24.362 FVLS	10/86→02/90	38
F 90 19.372 FA	02/90→06/96	42	F 90 24.362 FNLS,24.362 FVLS	10/86→02/90	46
F 90 19.372 FA	02/90→06/96	46	F 90 24.372 DF	02/90→12/90	42
F 90 19.372 FAK	02/90→06/96	42	F 90 24.372 DF	05/90→12/90	38
F 90 19.372 FAK	02/90→06/96	46	F 90 24.372 DFK	02/90→12/90	42
F 90 19.372 FAS	02/90→06/96	42	F 90 24.372 DFK	05/90→12/90	38
F 90 19.372 FAS	02/90→06/96	46	F 90 24.372 DFS	05/90→12/90	38
F 90 19.372 FK	02/90→05/95	42	F 90 24.372 DFS,24.372 DFLS	02/90→04/95	42
F 90 19.372 FK	02/90→05/95	46	F 90 24.372 FNL,24.372 FNLL,24.372 FVL	02/90→05/95	42
F 90 19.372 FK	05/90→04/95	38	F 90 24.372 FNL,24.372 FNLL,24.372 FVL	02/90→05/95	46
F 90 19.372 FS,19.372 FLS,19.372 FLLS	02/90→05/95	42	F 90 24.372 FNLS,24.372 FVLS	02/90→05/95	42
F 90 19.372 FS,19.372 FLS,19.372 FLLS	02/90→05/95	46	F 90 24.372 FNLS,24.372 FVLS	02/90→05/95	46
F 90 19.372 FS,19.372 FLS,19.372 FLLS	05/90→04/95	38	F 90 24.372 FVL	05/90→12/90	38
F 90 19.402 F,19.402 FL,19.402 FLL	05/94→05/95	42	F 90 24.372 FVLS	05/90→12/90	38
F 90 19.402 FA	05/94→06/96	42	F 90 24.402 FNL,24.402 FNLL	05/94→05/95	42
F 90 19.402 FAK	05/94→06/96	42	F 90 24.422 DF	02/90→12/90	42
F 90 19.402 FAS	05/94→06/96	42	F 90 24.422 DFK	02/90→12/90	42
F 90 19.402 FK	05/94→05/95	42	F 90 24.422 DFS,24.422 DFLS	02/90→12/90	42
F 90 19.402 FS,19.402 FLS,19.402 FLLS	05/94→05/95	42	F 90 24.422 FNL,24.422 FNLL,24.422 FVL	02/90→05/95	42
F 90 19.422 F,19.422 FL,19.422 FLL	02/90→05/95	42	F 90 24.462 DF	02/89→02/90	60
F 90 19.422 FA	02/90→06/96	42	F 90 24.462 DFS	02/89→02/90	60
F 90 19.422 FAK	02/90→06/96	42	F 90 24.462 FNL	04/89→02/90	60
F 90 19.422 FAS	02/90→06/96	42	F 90 24.462 FVLS	05/87→07/87	60
F 90 19.422 FK	02/90→05/95	42	F 90 24.502 DF	02/90→12/90	60
F 90 19.422 FS,19.422 FLS,19.422 FLLS	02/90→05/95	42	F 90 24.502 DFK	02/90→12/90	60
F 90 19.462 F,19.462 FL	05/87→02/90	60	F 90 24.502 DFS	02/90→12/90	60
F 90 19.462 FK	05/87→02/90	60	F 90 24.502 FNL	02/90→12/90	60
F 90 19.462 FS,19.462 FLS	05/87→02/90	60	F 90 25.272 DF	09/90→12/92	31
F 90 19.502 F,19.502 FL,19.502 FLL	02/90→06/96	60	F 90 25.272 DF	09/90→12/92	32
F 90 19.502 FS,19.502 FLS,19.502 FLLS	02/90→06/96	60	F 90 25.272 DFK	09/90→12/92	31
F 90 24.242 DF	01/88→07/89	38	F 90 25.272 DFK	09/90→12/92	32
F 90 24.242 DFK	01/88→07/89	38	F 90 25.272 DFS,25.272 DFLS	09/90→12/92	31
F 90 24.242 DFS	01/88→07/89	38	F 90 25.272 DFS,25.272 DFLS	09/90→12/92	32
F 90 24.242 FNL,24.242 FNLL,24.242 FVL	01/88→02/90	38	F 90 25.272 FNL,25.272 FNLL,25.272 FVL	09/90→10/93	31
F 90 24.262 DF	01/88→02/90	30	F 90 25.272 FNL,25.272 FNLL,25.272 FVL	09/90→10/93	32
F 90 24.262 DFK	01/88→02/90	30	F 90 25.302 DF	09/90→12/91	42
F 90 24.262 DFS,24.262 DFLS	01/88→02/90	30	F 90 25.302 DFK	09/90→12/91	42
F 90 24.262 FNL,24.262 FNLL,24.262 FVL	01/88→02/90	30	F 90 25.302 DFS,25.302 DFLS	09/90→12/91	42
F 90 24.272 DF	02/90→12/90	31	F 90 25.302 FNL,25.302 FNLL	09/90→12/91	42
F 90 24.272 DFK	02/90→12/90	31	F 90 25.302 FNLS,25.302 FVLS	09/90→12/91	42
F 90 24.272 DFS,24.272 DFLS	02/90→04/95	31	F 90 25.322 DF	09/90→12/92	32
F 90 24.272 FNL,24.272 FNLL,24.272 FVL	02/90→05/95	31	F 90 25.322 DFK	09/90→12/92	32
F 90 24.272 FNLS,24.272 FVLS	02/90→05/95	31	F 90 25.322 DFS,25.322 DFLS	09/90→12/92	32
F 90 24.272 FNLS,24.272 FVLS	02/90→05/95	32	F 90 25.322 FNL,25.322 FNLL	09/90→12/92	32
F 90 24.292 DF	04/87→02/90	41	F 90 25.322 FNLS,25.322 FVLS	09/90→12/92	32
F 90 24.292 DFK	04/87→02/90	41	F 90 25.372 DF	09/90→12/92	38
F 90 24.292 DFS,24.292 DFLS	04/87→02/90	41	F 90 25.372 DF	09/90→12/92	42
F 90 24.292 FNL,24.292 FNLL,24.292 FVL	10/86→02/90	41	F 90 25.372 DFK	09/90→12/92	38
F 90 24.292 FNLS,24.292 FVLS	10/86→02/90	41	F 90 25.372 DFK	09/90→12/92	42
F 90 24.302 DF	05/90→12/90	42	F 90 25.372 DFS	09/90→12/92	38
F 90 24.302 DFK	05/90→12/90	42	F 90 25.372 DFS,25.372 DFLS	09/90→12/92	42
F 90 24.302 DFS,24.302 DFLS	05/90→04/95	42	F 90 25.372 FNL,25.372 FNLL	09/90→12/92	42
			F 90 25.372 FNLS,25.372 FVLS	09/90→10/93	42



21

9

F 90 25.372 FVLS	09/90→10/93	38
F 90 25.422 DF	09/90→12/92	42
F 90 25.422 DFK	09/90→12/92	42
F 90 25.422 DFS,25.422 DFLS	09/90→12/92	42
F 90 25.422 FNL,25.422 FNLL	09/90→12/92	42
F 90 25.422 FNLS,25.422 FVLS	09/90→12/92	42
F 90 25.502 DF	09/90→12/92	60
F 90 25.502 DFS	09/90→12/92	60
F 90 25.502 FNL	09/90→12/92	60
F 90 26.242 DF	01/88→07/89	38
F 90 26.242 DFAK	02/89→07/89	38
F 90 26.242 DFK	01/88→07/89	38
F 90 26.242 DFS	01/88→07/89	38
F 90 26.262 DF	01/88→02/90	30
F 90 26.262 DFA	02/89→02/90	30
F 90 26.262 DFAK	02/89→02/90	30
F 90 26.262 DFAS	02/89→02/90	30
F 90 26.262 DFK	01/88→02/90	30
F 90 26.262 DFS	01/88→02/90	30
F 90 26.272 DF	02/90→06/96	31
F 90 26.272 DF	02/90→06/96	32
F 90 26.272 DFA	02/90→12/92	31
F 90 26.272 DFA	02/90→12/92	32
F 90 26.272 DFAK	02/90→12/92	31
F 90 26.272 DFAK	02/90→12/92	32
F 90 26.272 DFAS	02/90→12/92	31
F 90 26.272 DFAS	02/90→12/92	32
F 90 26.272 DFK	02/90→06/96	31
F 90 26.272 DFK	02/90→06/96	32
F 90 26.272 DFS,26.272 DFLS	02/90→06/96	31
F 90 26.272 DFS,26.272 DFLS	02/90→06/96	32
F 90 26.272 FNL,26.272 FNLL	03/91→05/95	32
F 90 26.272 FNLS,26.272 FVLS	09/90→12/95	31
F 90 26.272 FNLS,26.272 FVLS	09/90→12/95	32
F 90 26.292 DF	09/87→02/90	41
F 90 26.292 DFA	05/88→02/90	41
F 90 26.292 DFAK	05/88→02/90	41
F 90 26.292 DFAS	05/88→02/90	41
F 90 26.292 DFK	09/87→02/90	41
F 90 26.292 DFS	09/87→02/90	41
F 90 26.302 DF	05/90→12/91	42
F 90 26.302 DFA	05/90→12/91	42
F 90 26.302 DFAK	05/90→12/91	42
F 90 26.302 DFAS	05/90→12/91	42
F 90 26.302 DFK	05/90→12/91	42
F 90 26.302 DFS	05/90→12/91	42
F 90 26.302 FNL,26.302 FNLL	03/91→12/91	42
F 90 26.302 FNLS,26.302 FVLS	09/90→12/91	42
F 90 26.322 DF	02/90→06/96	32
F 90 26.322 DFA	02/90→12/92	32
F 90 26.322 DFAK	02/90→12/92	32
F 90 26.322 DFAS	02/90→12/92	32
F 90 26.322 DFK	02/92→06/96	32
F 90 26.322 DFS,26.322 DFLS	02/90→06/96	32
F 90 26.322 FNL,26.322 FNLL	03/91→05/95	32
F 90 26.322 FNLS,26.322 FVLS	09/90→12/95	32
F 90 26.332 DF	09/87→02/90	41
F 90 26.332 DFA	05/88→02/90	41
F 90 26.332 DFAK	05/88→02/90	41
F 90 26.332 DFAS	05/88→02/90	41
F 90 26.332 DFK	09/87→02/90	41
F 90 26.332 DFS	09/87→02/90	41
F 90 26.342 DF,26.342 DFL	05/94→06/96	32
F 90 26.342 DFK,26.342 DFLK	05/94→06/96	32
F 90 26.342 DFS	04/94→06/96	32
F 90 26.362 DF,26.362 DFL	09/87→02/90	38
F 90 26.362 DF,26.362 DFL	09/87→02/90	46
F 90 26.362 DFA	05/88→02/90	38
F 90 26.362 DFAK	05/88→02/90	38
F 90 26.362 DFAS	05/88→02/90	38
F 90 26.362 DFK	09/87→02/90	38
F 90 26.362 DFK	09/87→02/90	46
F 90 26.362 DFS	09/87→02/90	38



21

9

F 90 26.362 DFS	09/87→02/90	46
F 90 26.372 DF,26.372 DFL	02/90→06/96	42
F 90 26.372 DF,26.372 DFL	02/90→06/96	46
F 90 26.372 DFA	02/90→12/92	42
F 90 26.372 DFAK	01/92→06/96	42
F 90 26.372 DFAS	02/90→12/92	42
F 90 26.372 DFK	01/92→06/96	42
F 90 26.372 DFK	01/92→06/96	46
F 90 26.372 DFS	02/90→06/96	42
F 90 26.372 DFS	02/90→06/96	46
F 90 26.372 FNL,26.372 FNLL,26.372 FVL	09/90→12/95	42
F 90 26.372 FNL,26.372 FNLL,26.372 FVL	09/90→12/95	46
F 90 26.372 FNLS,26.372 FVLS	01/92→06/96	42
F 90 26.372 FNLS,26.372 FVLS	01/92→06/96	46
F 90 26.402 DF,26.402 DFL	05/94→06/96	42
F 90 26.402 DFK,26.402 DFLK	05/94→06/96	42
F 90 26.402 DFS	05/94→12/95	42
F 90 26.402 FNL,26.402 FNLL,26.402 FVL	05/94→06/96	42
F 90 26.402 FNLS,26.402 FVLS	05/94→06/96	42
F 90 26.422 DF,26.422 DFL	02/90→06/96	42
F 90 26.422 DFA	02/90→12/92	42
F 90 26.422 DFAK	02/90→12/92	42
F 90 26.422 DFAS	02/90→12/92	42
F 90 26.422 DFK	02/90→12/95	42
F 90 26.422 DFS	02/90→12/95	42
F 90 26.422 FNL,26.422 FNLL,26.422 FVL	09/90→12/95	42
F 90 26.422 FNLS,26.422 FVLS	01/92→12/95	42
F 90 26.462 DF	02/89→02/90	60
F 90 26.462 DFA	08/89→02/90	60
F 90 26.462 DFAS	08/89→02/90	60
F 90 26.462 DFS	02/89→02/90	60
F 90 26.502 DF	02/90→06/96	60
F 90 26.502 DFA	02/90→12/92	60
F 90 26.502 DFS,26.502 DFLS	02/90→06/96	60
F 90 26.502 FNL,26.502 FNLL	09/91→06/96	60
F 90 32.262 VF	02/89→02/90	30
F 90 32.262 VFK	02/89→02/90	30
F 90 32.262 VFTM	02/89→02/90	30
F 90 32.272 VF	02/90→04/95	31
F 90 32.272 VF	02/90→04/95	32
F 90 32.272 VFK	02/90→04/95	31
F 90 32.272 VFK	02/90→04/95	32
F 90 32.292 VF	03/88→02/90	41
F 90 32.292 VFK	03/88→02/90	41
F 90 32.302 VF	05/90→09/91	42
F 90 32.302 VFK	05/90→09/91	42
F 90 32.322 VF	02/90→06/96	32
F 90 32.322 VFK	02/90→06/96	32
F 90 32.332 VF	03/88→02/90	41
F 90 32.332 VFK	03/88→02/90	41
F 90 32.342 VFK	05/94→06/96	32
F 90 32.362 VF	03/88→02/90	38
F 90 32.362 VFK	03/88→02/90	38
F 90 32.372 VF	02/90→06/96	38
F 90 32.372 VF	02/90→06/96	42
F 90 32.372 VF	02/90→06/96	46
F 90 32.372 VFK	02/90→06/96	42
F 90 32.372 VFK	02/90→06/96	46
F 90 32.372 VFK	05/90→04/95	38
F 90 32.402 VFK	05/94→06/96	42
F 90 32.422 VF	02/90→06/96	42
F 90 33.242 DFAK	01/88→08/88	38
F 90 33.242 DFK	01/88→08/88	38
F 90 33.262 DF	08/88→02/90	30
F 90 33.262 DFA	07/89→02/90	30
F 90 33.262 DFAK	07/89→02/90	30
F 90 33.262 DFK	08/88→02/90	30
F 90 33.272 DF	10/92→04/95	32
F 90 33.272 DFA	10/92→04/95	32
F 90 33.272 FVL	10/92→04/95	32
F 90 33.292 DF	09/87→02/90	41
F 90 33.292 DFA	05/88→02/90	41



21

9



21

9

F 90 33.292 DFAK	05/88→02/90	41	F 90 35.372 VFK	02/90→12/97	46
F 90 33.292 DFAS	05/88→02/90	41	F 90 35.402 VF	05/94→12/97	42
F 90 33.292 DFK	09/87→02/90	41	F 90 35.402 VFK	05/94→12/97	42
F 90 33.292 DFS	09/87→02/90	41	F 90 35.422 VF	02/90→12/97	42
F 90 33.322 DF	09/91→06/96	32	F 90 35.422 VFK	02/90→12/97	42
F 90 33.322 DFA	09/91→06/96	32	F 90 40.372 DF	12/91→06/96	42
F 90 33.322 FVL	09/91→06/96	32	F 90 40.372 DF	12/91→06/96	46
F 90 33.332 DF	09/87→02/90	41	F 90 40.372 DFA	12/91→06/96	42
F 90 33.332 DFA	05/88→02/90	41	F 90 40.372 DFA	12/91→06/96	46
F 90 33.332 DFAK	05/88→02/90	41	F 90 40.402 DF	05/95→06/96	42
F 90 33.332 DFAS	05/88→02/90	41	F 90 40.402 DFA	05/95→06/96	42
F 90 33.332 DFK	09/87→02/90	41	F 90 40.422 DF	12/91→06/96	42
F 90 33.332 DFS	09/87→02/90	41	F 90 40.422 DFA	12/91→06/96	42
F 90 33.342 DF	05/94→06/96	32	F 90 40.462 DF	07/89→02/90	60
F 90 33.342 DFA	05/94→06/96	32	F 90 40.462 DFA	07/89→02/90	60
F 90 33.362 DF	09/87→02/90	38	F 90 40.502 DFA	02/90→06/96	60
F 90 33.362 DF	09/87→02/90	46	F 90 41.262 VF	07/89→02/90	30
F 90 33.362 DFA	05/88→02/90	38	F 90 41.262 VFK	07/89→02/90	30
F 90 33.362 DFAK	05/88→02/90	38	F 90 41.272 VF	02/90→12/91	31
F 90 33.362 DFAS	05/88→02/90	38	F 90 41.292 VF	10/88→02/90	41
F 90 33.362 DFK	09/87→02/90	38	F 90 41.292 VFK	10/88→02/90	41
F 90 33.362 DFK	09/87→02/90	46	F 90 41.322 VF	02/90→06/96	32
F 90 33.362 DFS	09/87→02/90	38	F 90 41.332 VF	10/88→02/90	41
F 90 33.362 DFS	09/87→02/90	46	F 90 41.332 VFK	10/88→02/90	41
F 90 33.372 DF	09/91→06/96	42	F 90 41.342 VF	05/94→06/96	32
F 90 33.372 DF	09/91→06/96	46	F 90 41.362 VF	10/88→02/90	38
F 90 33.372 DFA	09/91→06/96	42	F 90 41.362 VFK	10/88→02/90	38
F 90 33.372 DFA	09/91→06/96	46	F 90 41.372 VF	02/90→06/96	42
F 90 33.372 DFAK	01/91→06/96	42	F 90 41.372 VF	02/90→06/96	46
F 90 33.372 DFAK	01/91→06/96	46	F 90 41.402 VF	05/94→06/96	42
F 90 33.372 DFK	01/91→06/96	42	F 90 41.422 VF	02/90→06/96	42
F 90 33.372 DFK	01/91→06/96	46	F 90 48.292 VF	07/89→02/90	41
F 90 33.372 DFS	09/91→06/96	42	F 90 48.292 VFA	07/89→02/90	41
F 90 33.372 DFS	09/91→06/96	46	F 90 48.292 VFAK	07/89→02/90	41
F 90 33.402 DF	05/94→06/96	42	F 90 48.332 VF	07/89→02/90	41
F 90 33.402 DFA	05/94→06/96	42	F 90 48.332 VFA	07/89→02/90	41
F 90 33.402 DFAK	05/94→06/96	42	F 90 48.332 VFAK	07/89→02/90	41
F 90 33.402 DFK	05/94→06/96	42	F 90 48.362 VF	07/89→02/90	38
F 90 33.402 DFS	05/94→06/96	42	F 90 48.362 VFA	07/89→02/90	38
F 90 33.422 DF	09/91→06/96	42	F 90 48.362 VFAK	07/89→02/90	38
F 90 33.422 DFA	09/91→06/96	42	F 90 48.462 VF	07/89→02/90	60
F 90 33.422 DFAK	01/94→06/96	42	F 90 Unterflur 19.322 U,19.322 ULL	02/90→05/94	32
F 90 33.422 DFK	01/94→06/96	42	F 90 Unterflur 19.332 U,19.322 ULL	07/86→02/90	46
F 90 33.422 DFS	01/94→06/96	42	F 90 Unterflur 19.362 U,19.362 ULL	07/86→01/91	41
F 90 33.462 DF	07/89→02/90	60	F 90 Unterflur 19.372 U,19.372 ULL	02/90→05/94	42
F 90 33.462 DFA	07/89→02/90	60	F 90 Unterflur 19.422 U,19.422 ULL	02/90→05/94	42
F 90 33.502 DF	09/91→06/96	60	F 90 Unterflur 24.322 UNL,24.322 UNLL	02/90→12/90	32
F 90 33.502 DFA	09/91→06/96	60	F 90 Unterflur 24.332 UNL,24.332 UNLL	10/86→02/90	46
F 90 35.262 VF	02/89→02/90	30	F 90 Unterflur 24.362 UNL,24.362 UNLL	10/86→02/90	41
F 90 35.262 VFA	07/89→02/90	30	F 90 Unterflur 24.372 UNL,24.372 UNLL	02/90→12/90	42
F 90 35.262 VFK	02/89→02/90	30	F 90 Unterflur 24.422 UNL,24.422 UNLL	02/90→12/90	42
F 90 35.272 VF	02/90→12/91	31	F 90 Unterflur 25.322 UNL,25.322 UNLL	09/90→12/92	32
F 90 35.272 VFK	02/90→12/92	31	F 90 Unterflur 25.372 UNL,25.372 UNLL	09/90→12/92	42
F 90 35.292 VF	10/88→04/95	41	F 90 Unterflur 25.422 UNL,25.422 UNLL	09/90→12/92	42
F 90 35.292 VFK	10/88→04/95	41	F 90 Unterflur 26.322 UNL,26.322 UNLL	09/90→05/94	32
F 90 35.302 VF	05/90→09/91	42	F 90 Unterflur 26.372 UNL,26.372 UNLL	09/90→05/94	42
F 90 35.302 VFA	05/90→09/91	42	F 90 Unterflur 26.422 UNL,26.422 UNLL	09/90→05/94	42
F 90 35.302 VFAK	05/90→09/91	42	F 2000 19.233 FCNG		39
F 90 35.302 VFK	05/90→09/91	42	F 2000 19.233 FKNG		39
F 90 35.322 VFAK	02/90→06/96	32	F 2000 19.273 F, FL, FLL	01/94→	32
F 90 35.322 VFK	02/90→06/96	32	F 2000 19.273 FA	01/94→	32
F 90 35.322 VK	02/90→06/96	32	F 2000 19.273 FAK	01/94→	32
F 90 35.332 VF	10/88→04/95	38	F 2000 19.273 FK	01/94→	32
F 90 35.332 VFK	10/88→04/95	38	F 2000 19.273 FS,19.273 FLS	01/94→12/95	32
F 90 35.342 VF	05/94→06/96	32	F 2000 19.293 FAC	01/94→	32
F 90 35.342 VFK	05/94→06/96	32	F 2000 19.293 FAK	01/94→	32
F 90 35.362 VF	10/88→02/90	38	F 2000 19.293 FAS	01/94→	32
F 90 35.362 VFK	10/88→02/90	38	F 2000 19.293 FC,19.293 FLC,19.293 FLLC	01/94→	32
F 90 35.372 VF	02/90→04/95	38	F 2000 19.293 FK,19.293 FLK	01/94→	32
F 90 35.372 VF	02/90→12/97	42	F 2000 19.293 FS,19.293 FLS,19.293 FLLS	01/94→	32
F 90 35.372 VF	02/90→12/97	46	F 2000 19.314 FAS	06/98→	44
F 90 35.372 VFK	02/90→04/95	38	F 2000 19.314 FC, FLC, FLLC, FLLW, FRC, FLRC, FLLRC, FLL, FLLR, F-N	06/98→	44
F 90 35.372 VFK	02/90→12/97	42	F 2000 19.314 FK, FLK, F-KI, FL-KI	06/98→	44



21

9

F 2000 19.314 FS, FLS, FLLS, FRS, FLRS, FLLRS	06/98→	44
F 2000 19.323 FAC	01/94→12/95	32
F 2000 19.323 FAK	01/94→12/95	32
F 2000 19.323 FAS	01/94→12/95	32
F 2000 19.323 FC, 19.323 FLC, 19.323 FLLC	01/94→12/95	32
F 2000 19.323 FK, 19.323 FLK	01/94→12/95	32
F 2000 19.323 FS, 19.323 FLS, 19.323 FLLS	01/94→12/95	32
F 2000 19.343 FAC	01/94→	32
F 2000 19.343 FAK	01/94→	32
F 2000 19.343 FAS	01/94→	32
F 2000 19.343 FC, 19.343 FLC, 19.343 FLLC	01/94→	32
F 2000 19.343 FK, 19.343 FLK	01/94→	32
F 2000 19.343 FS, 19.343 FLS, 19.343 FLLS	01/94→	32
F 2000 19.364 FAC	06/98→	44
F 2000 19.364 FAK, FA-KI	06/98→	44
F 2000 19.364 FAS	06/98→	44
F 2000 19.364 FC, FLC, FLLC, FLLW, FRC, FLRC, FLLRC, FLL, FLLR, F-N	06/98→	44
F 2000 19.364 FK, FLK, F-KI, FL-KI	06/98→	44
F 2000 19.364 FS, FLS, FLLS, FRS, FLRS, FLLRS	06/98→	44
F 2000 19.373 FAC	01/94→	44
F 2000 19.373 FAK, FA-KI	01/94→	44
F 2000 19.373 FAS	01/94→	44
F 2000 19.373 FC, FLC, FLLC, FRC, FLRC, F-NL	01/94→	44
F 2000 19.373 FK, FLK, F-KI, FL-KI	01/94→	44
F 2000 19.373 FS, FLS, FLLS, FRS, FLRS, FLLRS	01/94→	44
F 2000 19.403 FAC	01/94→	44
F 2000 19.403 FAK, FA-KI	01/94→	44
F 2000 19.403 FAS	01/94→	44
F 2000 19.403 FC, FLC, FLLC, FRC, FLRC, F-NL	01/94→	44
F 2000 19.403 FK, FLK, F-KI, FL-KI	01/94→	44
F 2000 19.403 FS, FLS, FLLS, FRS, FLRS, FLLRS	01/94→	44
F 2000 19.414 FAC	06/98→	43
F 2000 19.414 FAK, FA-KI	06/98→	43
F 2000 19.414 FAS	06/98→	43
F 2000 19.414 FC, FLC, FLLC, FRC, FLRC, FLLRC, FLL, FLLR, F-NL	06/98→	43
F 2000 19.414 FK, FLK, F-KI, FL-KI	06/98→	43
F 2000 19.414 FS, FLS, FLLS, FRS, FLRS, FLLRS	06/98→	43
F 2000 19.423 FAC	01/94→12/95	44
F 2000 19.423 FAK, FA-KI	01/94→	44
F 2000 19.423 FAS	01/94→12/95	44
F 2000 19.423 FC, FLC, FLLC, F-NL	01/94→	44
F 2000 19.423 FK, FLK, F-KI, FL-KI	01/94→	44
F 2000 19.423 FS, FLS, FLLS	01/94→	44
F 2000 19.463 FAC	01/94→	50
F 2000 19.463 FAK, FA-KI	01/94→	50
F 2000 19.463 FAS	01/94→	50
F 2000 19.463 FC, FLC, FLLC, FRC, FLRC, F-NL	01/94→	50
F 2000 19.463 FK, FLK, F-KI, FL-KI	01/94→	50
F 2000 19.463 FS, FLS, FLLS, FRS, FLRS, FLLRS	01/94→	50
F 2000 19.464 FAC	06/98→	51
F 2000 19.464 FAK, FA-KI	06/98→	51
F 2000 19.464 FAS	06/98→	51
F 2000 19.464 FC, FLC, FLLC, FLL, FRC, FLLR, FLLRC, FLLW, F-NL	06/98→	51
F 2000 19.464 FK, FLK, F-KI, FL-KI	06/98→	51
F 2000 19.464 FS, FLS, FLLS, FRS, FLRS, FLLRS	06/98→	51
F 2000 19.603 FLS, 19604 FLS	04/96→	60
F 2000 23.293 FNLLC	01/94→	32
F 2000 23.343 FNLLC	01/94→	32
F 2000 23.403 FNLLC	01/94→	44
F 2000 23.463 FNLLC	01/94→	50
F 2000 24.273 FNLLC	01/94→12/95	32
F 2000 24.293 FNLLC	01/94→	32
F 2000 24.323 FNLLC	01/94→12/95	32
F 2000 24.343 FNLLC	01/94→	32
F 2000 24.373 FNLLC	01/94→12/95	44
F 2000 24.403 FNLLC	01/94→	44
F 2000 24.423 FNLLC	01/94→12/95	44
F 2000 24.463 FNLLC	01/94→	50
F 2000 26.233 FVLCNG	09/96→	39
F 2000 26.273 DFC, 26.273 DFCL	01/94→12/95	32
F 2000 26.273 DFK, 26.273 DFLK	01/94→12/95	32
F 2000 26.273 DFS, 26.273 DFSL	01/94→12/95	32
F 2000 26.273 FNLC, 26.273 FNLLC, 26.273 FVLC	01/94→12/95	32



21

9

F 2000 26.273 FNLS, 26.273 FVLS	01/94→12/95	32
F 2000 26.293 DFC, 26.293 DFCL	01/94→	32
F 2000 26.293 DFK, 26.293 DFLK	01/94→	32
F 2000 26.293 DFS, 26.293 DFSL	01/94→	32
F 2000 26.293 FNLC, 26.293 FNLLC, 26.293 FVLC	01/94→	32
F 2000 26.293 FNLS, 26.293 FVLS	01/94→	32
F 2000 26.314 DFK, DFLK	05/01→	43
F 2000 26.314 DFS, DFSL	05/01→	43
F 2000 26.314 DF-TM	05/01→	43
F 2000 26.314 FNLC, FNLLC, FNLLRC, FNLLW, FVLC	05/01→	43
F 2000 26.314 FNLS	05/01→	43
F 2000 26.314 FVL-KO	05/01→	43
F 2000 26.314 FVLS, FVLS	05/01→	43
F 2000 26.323 DFC, 26.323 DFCL	01/94→12/95	32
F 2000 26.323 DFK, 26.323 DFLK	01/94→12/95	32
F 2000 26.323 DFS, 26.323 DFSL	01/94→12/95	32
F 2000 26.323 FNLC, 26.323 FNLLC, 26.323 FVLC	01/94→12/95	32
F 2000 26.323 FNLS, 26.323 FVLS	01/94→12/95	32
F 2000 26.343 DFC, 26.343 DFCL	01/94→	32
F 2000 26.343 DFK, 26.343 DFLK	01/94→	32
F 2000 26.343 DFS, 26.343 DFSL	01/94→	32
F 2000 26.343 FNLC, 26.343 FNLLC, 26.343 FVLC	01/94→	32
F 2000 26.343 FNLS, 26.343 FVLS	01/94→	32
F 2000 26.364 DFC, DFLC	05/01→	43
F 2000 26.364 DFK, DFLK	05/01→	43
F 2000 26.364 DFS, DFSL	05/01→	43
F 2000 26.364 DF-TM	05/01→	43
F 2000 26.364 FNLC, FNLLC, FNLLRC, FNLLW, FVLC	05/01→	43
F 2000 26.364 FNLS	05/01→	43
F 2000 26.364 FVL-KO	05/01→	43
F 2000 26.364 FVLS, FVLS	05/01→	43
F 2000 26.373 DFC, 26.373 DFCL	01/94→12/95	44
F 2000 26.373 DFK, 26.373 DFLK	01/94→12/95	44
F 2000 26.373 DFS, 26.373 DFSL	01/94→12/95	44
F 2000 26.373 FNLC, 26.373 FNLLC, 26.373 FVLC	01/94→12/95	44
F 2000 26.373 FNLS, 26.373 FVLS	01/94→12/95	44
F 2000 26.403 DFC, 26.403 DFCL	01/94→	44
F 2000 26.403 DFK, 26.403 DFLK	01/94→	44
F 2000 26.403 DFS, 26.403 DFSL	01/94→	44
F 2000 26.403 FNLC, 26.403 FNLLC, 26.403 FVLC	01/94→	44
F 2000 26.403 FNLS, 26.403 FVLS	01/94→	44
F 2000 26.414 DFC, DFCL	05/01→	43
F 2000 26.414 DFK, DFLK	05/01→	43
F 2000 26.414 DFS, DFSL	05/01→	43
F 2000 26.414 DF-TM	05/01→	43
F 2000 26.414 FNLC, FNLLC, FNLLRC, FNLLW, FVLC	05/01→	43
F 2000 26.414 FNLS	05/01→	43
F 2000 26.414 FVL-KO	05/01→	43
F 2000 26.414 FVLS, FVLS	05/01→	43
F 2000 26.423 DFC, 26.423 DFCL	01/94→12/95	44
F 2000 26.423 DFK, 26.423 DFLK	01/94→12/95	44
F 2000 26.423 DFS, 26.423 DFSL	01/94→12/95	44
F 2000 26.423 FNLC, 26.423 FNLLC, 26.423 FVLC	01/94→12/95	44
F 2000 26.423 FNLS, 26.423 FVLS	01/94→12/95	44
F 2000 26.463 DFC, DFCL	01/94→	50
F 2000 26.463 DFK, 26.463 DFLK	01/94→	50
F 2000 26.463 DFS, 26.463 DFSL	01/94→	50
F 2000 26.463 FNLC, FNLLC, FVLC	01/94→	50
F 2000 26.464 DFC, DFCL	05/01→	51
F 2000 26.464 DFK, DFLK	05/01→	51
F 2000 26.464 DFS, DFSL	05/01→	51
F 2000 26.464 DF-TM	05/01→	51
F 2000 26.464 FNLC, FNLLC, FNLLW, FVLC	05/01→	51
F 2000 26.464 FNLS	05/01→	51
F 2000 26.464 FVL-KO	05/01→	51
F 2000 26.464 FVLS, FVLS	05/01→	51
F 2000 26.603 DFC, DFCL	06/96→	60
F 2000 26.603 DFK, DFLK	06/96→	60
F 2000 26.603 DFS, DFSL	06/96→	60
F 2000 27.273 DFAC	01/94→12/95	32
F 2000 27.273 DFAK	01/94→12/95	32
F 2000 27.273 DFAS	01/94→12/95	32



21

9



21

9

F 2000 27.273 DFC	01/94→12/95	32	F 2000 32.464 VF, VFC	05/01→	51
F 2000 27.273 DFK	01/94→12/95	32	F 2000 32.464 VFK, VF-HK	05/01→	51
F 2000 27.273 DFS	01/94→12/95	32	F 2000 32.464 VF-TM	05/01→	51
F 2000 27.293 DFAC	01/94→	32	F 2000 33.323 DFAC	01/94→12/95	32
F 2000 27.293 DFAK	01/94→	32	F 2000 33.323 DFAK	01/94→12/95	32
F 2000 27.293 DFAS	01/94→	32	F 2000 33.323 DFAS	01/94→12/95	32
F 2000 27.293 DFC	01/94→	32	F 2000 33.323 DFC	01/94→12/95	32
F 2000 27.293 DFK	01/94→	32	F 2000 33.323 DFK	01/94→12/95	32
F 2000 27.293 DFS	01/94→	32	F 2000 33.323 DFS	01/94→12/95	32
F 2000 27.314 DFAC	05/01→	43	F 2000 33.343 DFAC	01/94→	32
F 2000 27.314 FVL	06/98→	43	F 2000 33.343 DFAK	01/94→	32
F 2000 27.323 DFAC	01/94→12/95	32	F 2000 33.343 DFAS	01/94→	32
F 2000 27.323 DFAK, DFA-KI	01/94→	32	F 2000 33.343 DFC	01/94→	32
F 2000 27.323 DFAS	01/94→12/95	32	F 2000 33.343 DFK	01/94→	32
F 2000 27.323 DFC	01/94→12/95	32	F 2000 33.343 DFS	01/94→	32
F 2000 27.323 DFK, DF-KI	01/94→	32	F 2000 33.373 DFAC	01/94→	44
F 2000 27.323 DFS	01/94→12/95	32	F 2000 33.373 DFAK, DFA-KI	01/94→	44
F 2000 27.343 DFAC	01/94→	32	F 2000 33.373 DFAS	01/94→	44
F 2000 27.343 DFAK	01/94→	32	F 2000 33.373 DFC	01/94→	44
F 2000 27.343 DFAS	01/94→	32	F 2000 33.373 DFK, DF-KI	01/94→	44
F 2000 27.343 DFC	01/94→	32	F 2000 33.373 DFS, DFRS	01/94→	44
F 2000 27.343 DFK	01/94→	32	F 2000 33.403 DFAC	01/94→	44
F 2000 27.343 DFS	01/94→	32	F 2000 33.403 DFAK, DFA-KI	01/94→	44
F 2000 27.364 DFAC	05/01→	43	F 2000 33.403 DFAS	01/94→	44
F 2000 27.364 FVL	06/98→	43	F 2000 33.403 DFC	01/94→	44
F 2000 27.373 DFAC	01/94→	44	F 2000 33.403 DFK, DF-KI	01/94→	44
F 2000 27.373 DFAK, DFA-KI	01/94→	44	F 2000 33.403 DFS, DFRS	01/94→	44
F 2000 27.373 DFAS	01/94→	44	F 2000 33.423 DFAC	01/94→	44
F 2000 27.373 DFC	01/94→	44	F 2000 33.423 DFAK, DFA-KI	01/94→	44
F 2000 27.373 DFK, DF-KI	01/94→	44	F 2000 33.423 DFAS	01/94→	44
F 2000 27.373 DFS	01/94→	44	F 2000 33.423 DFC	01/94→	44
F 2000 27.403 DFAC	01/94→	44	F 2000 33.423 DFK, DF-KI	01/94→	44
F 2000 27.403 DFAK, DFA-KI	01/94→	44	F 2000 33.423 DFS, DFRS	01/94→	44
F 2000 27.403 DFAS	01/94→	44	F 2000 33.463 DFAC	01/94→	50
F 2000 27.403 DFC	01/94→	44	F 2000 33.463 DFAK, DFA-KI	01/94→	50
F 2000 27.403 DFK, DF-KI	01/94→	44	F 2000 33.463 DFAS	01/94→	50
F 2000 27.403 DFS	01/94→	44	F 2000 33.463 DFC	01/94→	50
F 2000 27.414 DFAC	05/01→	43	F 2000 33.463 DFK, DF-KI	01/94→	50
F 2000 27.414 FVL	06/98→	43	F 2000 33.463 DFS, DFRS	01/94→	50
F 2000 27.423 DFAC	01/94→	44	F 2000 33.603 DFAC	06/96→	60
F 2000 27.423 DFAK, DFA-KI	01/94→	44	F 2000 33.603 DFAS	06/96→	60
F 2000 27.423 DFAS	01/94→12/95	44	F 2000 33.603 DFC	06/96→	60
F 2000 27.423 DFC	01/94→	44	F 2000 33.603 DFS	06/96→	60
F 2000 27.423 DFK, DF-KI	01/94→	44	F 2000 35.343 VFC	08/95→	32
F 2000 27.423 DFS	01/94→	44	F 2000 35.364 VFK, VF-HK, VF-KI	03/02→	43
F 2000 27.463 DFAC	01/94→	50	F 2000 35.364 VF-TM	03/02→	43
F 2000 27.463 DFAK, DFA-KI	01/94→	50	F 2000 35.403 VF, VFC, VFRC	08/95→	44
F 2000 27.463 DFAS	01/94→	50	F 2000 35.403 VFK, VF-HK, VF-KI	03/02→	44
F 2000 27.463 DFC	01/94→	50	F 2000 35.414 VF, VFC, VFRC	05/01→	43
F 2000 27.463 DFK, DF-KI	01/94→	50	F 2000 35.414 VFK, VF-HK, VF-KI	03/02→	43
F 2000 27.463 DFS	01/94→	50	F 2000 35.414 VF-TM	03/02→	43
F 2000 27.464 DFAC	05/01→	51	F 2000 35.463 VF, VFC, VFRC	08/95→	50
F 2000 27.464 DFC	01/94→	51	F 2000 35.463 VFK, VF-HK, VF-KI	08/95→	50
F 2000 27.464 DFS	01/94→	51	F 2000 35.464 VF, VFC, VFRC	05/01→	51
F 2000 27.464 FVL	06/98→	51	F 2000 35.464 VFK, VF-HK, VF-KI	03/02→	51
F 2000 27.603 DFAS	01/96→	60	F 2000 35.464 VF-TM	03/02→	51
F 2000 27.603 DFS	01/96→	60	F 2000 37.414 VFA	06/98→	43
F 2000 32.293 VFC	08/95→	32	F 2000 37.464 VFA	06/98→	51
F 2000 32.314 VF, VFC	05/01→	43	F 2000 40.273 DFAK	01/94→	32
F 2000 32.314 VFK, VF-HK	05/01→	43	F 2000 40.273 DFK	01/94→	32
F 2000 32.314 VF-TM	05/01→	43	F 2000 40.403 DFAK	01/94→	44
F 2000 32.343 VFC	08/95→	32	F 2000 40.403 DFAS	01/94→	44
F 2000 32.343 VFK	08/95→	32	F 2000 40.403 DFK	01/94→	44
F 2000 32.364 VF, VFC	05/01→	43	F 2000 40.403 DFS	01/94→	44
F 2000 32.364 VFK, VF-HK	05/01→	43	F 2000 40.463 DFAK	01/94→	50
F 2000 32.364 VF-TM	05/01→	43	F 2000 40.463 DFAS	01/94→	50
F 2000 32.403 VFC	08/95→	44	F 2000 40.463 DFK	01/94→	50
F 2000 32.403 VFK	08/95→	44	F 2000 40.463 DFS	01/94→	50
F 2000 32.414 VF, VFC	05/01→	43	F 2000 41.343 VFC	08/95→	32
F 2000 32.414 VFK, VF-HK	05/01→	43	F 2000 41.343 VFK	08/95→	32
F 2000 32.414 VF-TM	05/01→	43	F 2000 41.403 VF, VFC, VFRC	08/95→	44
F 2000 32.463 VFC	08/95→	50			
F 2000 32.463 VFK	08/95→	50			



21

9

F 2000 41.403 VFK, VF-HK, VF-KI	08/95→	44
F 2000 41.463 VF, VFC, VFRC	08/95→	50
F 2000 41.463 VFK, VF-HK, VF-KI	08/95→	50
F 2000 41.464 VF, VFC, VFRC	06/98→	51
FOCL 12.240		22
G 6.90 F	10/79→09/87	1
G 6.90 FK	10/79→09/87	1
G 8.136 F, 8.136 FL	10/79→09/87	7
G 8.136 FAE	12/83→08/88	7
G 8.136 FK	10/79→08/88	7
G 8.136 FOC	03/82→07/88	7
G 8.90 F	10/79→09/87	1
G 8.90 FK	10/79→09/87	1
G 9.136 F, 9.136 FL	10/79→09/87	7
G 9.136 FAE	12/83→08/88	7
G 9.136 FK	10/79→08/88	7
G 9.136 FOC	03/82→07/88	7
G 10.136 F, 10.136 FL	09/81→09/87	7
G 10.136 FK	09/81→09/87	7
G 90 10.150 F, 10.150 FL	09/87→10/93	16
G 90 10.150 F, 10.150 FL	09/87→10/93	17
G 90 10.150 F, 10.150 FL	05/90→10/93	7
G 90 10.150 FK	09/87→10/93	16
G 90 10.150 FK	09/87→10/93	17
G 90 6.100 F	09/87→10/93	3
G 90 6.100 FK	09/87→10/93	3
G 90 8.100 F	09/87→10/93	3
G 90 8.100 FK	09/87→10/93	3
G 90 8.150 F, 8.150 FL	09/87→10/93	16
G 90 8.150 F, 8.150 FL	09/87→10/93	17
G 90 8.150 F, 8.150 FL	05/90→10/93	7
G 90 8.150 FAE	05/88→05/95	16
G 90 8.150 FAE	05/88→05/95	17
G 90 8.150 FAKO	10/92→05/95	16
G 90 8.150 FK	09/87→10/93	16
G 90 8.150 FK	09/87→10/93	17
G 90 8.150 FOC	07/88→10/93	16
G 90 8.150 FOC	07/88→10/93	17
G 90 8.150 FS, 8.150 FLS	09/87→10/93	16
G 90 8.150 FS, 8.150 FLS	09/87→10/93	17
G 90 8.170 FOC	02/89→10/93	8
G 90 9.150 F, 9.150 FL	09/87→10/93	16
G 90 9.150 F, 9.150 FL	09/87→10/93	17
G 90 9.150 F, 9.150 FL	05/90→10/93	7
G 90 9.150 FAE	05/88→05/92	16
G 90 9.150 FAE	05/88→05/92	17
G 90 9.150 FAKO	10/92→05/95	16
G 90 9.150 FK	09/87→10/93	16
G 90 9.150 FK	09/87→10/93	17
G 90 9.150 FOC	07/88→10/93	16
G 90 9.150 FOC	07/88→10/93	17
G 90 9.150 FS, 9.150 FLS	09/87→10/93	16
G 90 9.150 FS, 9.150 FLS	09/87→10/93	17
G 90 9.170 FOC	02/89→10/93	8
HELICON 380	01/87→	41
HOCL 12.240 HOCL-NL		22
HOCL 14.240 HOCL-NL		22
HOCL 14.280 HOCL		22
HOCL 18.240 HOCL-NL		22
HOCL 18.280 HOCL-NL		19
HOCL 18.280 HOCL-NL		22
Industrial	01/76→	57
Industrial	01/77→	62
Industrial	01/87→12/90	61
L 2000 10.145 LC, 10.145 LLC, LRC, LLRC (LE140C)	09/00→	2
L 2000 10.145 LK, LRK, L-KI, LR-KI (LE140C)	09/00→	2
L 2000 10.145 LLS, LLRS (LE140C)	09/00→	2
L 2000 10.150 FOC	02/95→01/96	4
L 2000 10.153 LAEK	10/93→06/96	2
L 2000 10.153 LC, 10.153 LLC	10/93→06/96	2
L 2000 10.153 LK	10/93→06/96	2
L 2000 10.153 LLS	10/93→06/96	2
L 2000 10.163 LAC, LAEC, LARC, LAERC	05/94→	2



21

9

L 2000 10.163 LAK, LAEK, LARK, LAERK	01/95→	2
L 2000 10.163 LC, 10.163 LLC	05/94→	2
L 2000 10.163 LC, 10.163 LLC, LRC, LLRC (LE160C)	09/00→	2
L 2000 10.163 LK, LRK, L-KI, LR-KI	05/94→	2
L 2000 10.163 LLS, LLRS	05/94→	2
L 2000 10.185 LAC, LAEC, LARC, LAERC, LA-LA, LAE-LF (LE180C)	09/00→	2
L 2000 10.185 LAK, LAEK, LARK, LAERK (LE180C)	09/00→	2
L 2000 10.185 LC, 10.185 LLC, LRC, LLRC (LE180C)	09/00→	2
L 2000 10.185 LK, LRK, L-KI, LR-KI (LE180C)	09/00→	2
L 2000 10.185 LLS, LLRS (LE180C)	09/00→	2
L 2000 10.220 FOC, 10.220 FOCL	02/95→	16
L 2000 10.223 LAEC	01/95→06/96	16
L 2000 10.223 LC, 10.223 LLC	10/93→06/96	16
L 2000 10.223 LC, 10.223 LLC	10/93→06/96	19
L 2000 10.223 LK	10/93→06/96	16
L 2000 10.223 LK	10/93→06/96	19
L 2000 10.223 LLS	10/93→06/96	16
L 2000 10.223 LLS	10/93→06/96	19
L 2000 10.224 LAC, LAEC, LARC, LAERC	01/95→	16
L 2000 10.224 LAC, LAEC, LARC, LAERC	01/95→	19
L 2000 10.224 LAK, LAEK, LARK, LAERK	01/95→	16
L 2000 10.224 LC, 10.224 LLC, LRC, LLRC	05/94→	16
L 2000 10.224 LC, 10.224 LLC, LRC, LLRC	05/94→	19
L 2000 10.224 LK, LRK, L-KI, LR-KI	05/94→	16
L 2000 10.224 LLS, LLRS	05/94→	16
L 2000 10.225 LAC, LAEC, LARC, LAERC, LA-LF, LAE-LF (LE220C)	09/00→	19
L 2000 10.225 LAK, LAEK, LARK, LAERK (LE220C)	09/00→	19
L 2000 10.225 LC, 10.225 LLC, LRC, LLRC	09/00→	19
L 2000 10.225 LC, 10.225 LLC, LRC, LLRC (LE220C)	09/00→	19
L 2000 10.225 LK, LRK, L-KI, LR-KI (LE220C)	09/00→	19
L 2000 10.225 LLS, LLRS (LE220C)	09/00→	19
L 2000 12.185 LC, LLC	09/99→	2
L 2000 12.225 LC, LLC (LE220C)	09/99→	19
L 2000 8.103 LC, 8.103 LLC	10/93→06/96	2
L 2000 8.103 LK	10/93→06/96	2
L 2000 8.113 LC, 8.113 LLC	08/95→	2
L 2000 8.113 LC, 8.113 LLC, LRC, LLRC, (LE110C)	09/00→	2
L 2000 8.113 LK, LRK, L-KI, LR-KI	08/95→	2
L 2000 8.145 LC, 8.145 LLC, L-LF (LE140C)	09/00→	2
L 2000 8.145 LLS, LLRS (LE140C)	09/00→	2
L 2000 8.145 LK, L-KI, LR-KI (LE140C)	09/00→	2
L 2000 8.150 FOC, 8.150 FOCL	02/95→	4
L 2000 8.153 LAEK	01/95→06/96	2
L 2000 8.153 LC, 8.153 LLC	10/93→07/97	2
L 2000 8.153 LK	10/93→07/97	2
L 2000 8.153 LLS	10/93→06/96	2
L 2000 8.163 LAC, LAEC, LARC, LAERC, LA-LF, LAE-LF	01/95→	2
L 2000 8.163 LAEK	08/95→03/97	2
L 2000 8.163 LC, 8.163 LLC	05/94→	2
L 2000 8.163 LC, 8.163 LLC, LRC, LLRC, L-LF	08/95→	2
L 2000 8.163 LK, LRK, L-KI, LR-KI	05/94→	2
L 2000 8.163 LLS, LLRS	05/94→	2
L 2000 8.185 LAC, LAEC, LARC, LAERC, LA-LF, LAE-LF (LE180C)	09/00→	2
L 2000 8.185 LAK, LAEK, LARK, LAERK (LE180C)	09/00→	2
L 2000 8.185 LC, 8.185 LLC, LRC, LLRC, L-LF (LE180C)	09/00→	2
L 2000 8.185 LK, LRK, L-KI, LR-KI (LE180C)	09/00→	2
L 2000 8.185 LLS, LLRS (LE180C)	09/00→	2
L 2000 8.220 FOC, 8.220 FOCL	04/95→	16
L 2000 8.223 LAEK	01/95→06/96	16
L 2000 8.223 LC, 8.223 LLC	10/93→06/96	16
L 2000 8.223 LC, 8.223 LLC	10/93→06/96	19
L 2000 8.223 LK	10/93→06/96	16
L 2000 8.223 LK	10/93→06/96	19
L 2000 8.223 LLS	10/93→06/96	16
L 2000 8.223 LLS	10/93→06/96	19
L 2000 8.224 LAC, LAEC, LARC, LAERC	01/95→	16
L 2000 8.224 LAK, LAEK, LARK, LAERK	01/95→	16
L 2000 8.224 LC, 8.224 LLC, LRC, LLRC	05/94→	16
L 2000 8.224 LK, LRK, L-KI, LR-KI	05/94→	16
L 2000 8.224 LLS, LLRS	05/94→	16
L 2000 8.225 LAC, LAEC, LARC, LAERC (LE220C)	09/00→	19
L 2000 8.225 LAK, LAEK, LARK, LAERK (LE220C)	09/00→	19



21

9



21

9

L 2000 8.225 LC,8.225 LLC, LRC, LLRC (LE220C)	09/00→	19	M 90 12.272 FS,12.272 FLS	10/92→06/96	16
L 2000 8.225 LK, LRK, L-KI, LR-KI (LE220C)	09/00→	19	M 90 14.152 F,14.152 FL	12/88→04/94	17
L 2000 8.225 LLS, LLRS (LE220C)	09/00→	19	M 90 14.152 F,14.152 FL	05/94→06/96	2
L 2000 9.145 LC,9.145 LLC, LRC, LLRC (LE140C)	09/00→	2	M 90 14.152 FK	12/88→05/94	17
L 2000 9.145 LK, LRK, L-KI, LR-KI (LE140C)	09/00→	2	M 90 14.152 FK	05/94→06/96	2
L 2000 9.145 LLS, LLRS (LE140C)	09/00→	2	M 90 14.152 FS,14.152 FLS	12/88→05/94	17
L 2000 9.153 LC,9.153 LLC	10/93→06/96	2	M 90 14.152 FS,14.152 FLS	05/94→06/96	2
L 2000 9.153 LK	10/93→06/96	2	M 90 14.162 F,14.162 FL	08/95→06/96	2
L 2000 9.153 LLS	10/93→12/95	2	M 90 14.162 FK	08/95→06/96	2
L 2000 9.163 LC	08/95→03/97	2	M 90 14.162 FS,14.162 FLS	08/95→06/96	2
L 2000 9.163 LC,9.163 LLC, LRC, LLRC	05/94→	2	M 90 14.192 F,14.192 FL	08/88→06/90	11
L 2000 9.163 LK	08/95→03/97	2	M 90 14.192 F,14.192 FL	07/90→06/96	16
L 2000 9.163 LK, LRK, L-KI, LR-KI	05/94→	2	M 90 14.192 FK	08/88→06/90	11
L 2000 9.163 LLS, LLRS	05/94→	2	M 90 14.192 FK	07/90→06/96	16
L 2000 9.185 LC,9.185 LLC, LRC, LLRC (LE180C)	09/00→	2	M 90 14.192 FS,14.192 FLS	08/88→06/90	11
L 2000 9.185 LK, LRK, L-KI, LR-KI (LE180C)	09/00→	2	M 90 14.192 FS,14.192 FLS	07/90→06/96	16
L 2000 9.185 LLS, LLRS (LE 180C)	09/00→	2	M 90 14.222 F,14.222 FL	05/94→06/96	16
L 2000 9.223 LC,9.223 LLC	10/93→06/96	16	M 90 14.222 FK	05/94→06/96	16
L 2000 9.223 LC,9.223 LLC	10/93→06/96	19	M 90 14.222 FLS	05/94→06/96	16
L 2000 9.223 LK	10/93→06/96	16	M 90 14.232 F,14.232 FL	08/88→06/96	16
L 2000 9.223 LK	10/93→06/96	19	M 90 14.232 F,14.232 FL	05/90→04/95	14
L 2000 9.223 LLS	10/93→06/96	16	M 90 14.232 FK	08/88→06/96	16
L 2000 9.223 LLS	10/93→06/96	19	M 90 14.232 FS,14.232 FLS	08/88→06/96	16
L 2000 9.224 LC,9.224 LLC, LRC, LLRC	05/94→	16	M 90 14.232 FS,14.232 FLS	05/90→04/95	14
L 2000 9.224 LK, LRK, L-KI, LR-KI	05/94→	16	M 90 14.262 F,14.262 FL	08/95→06/96	16
L 2000 9.224 LLS, LLRS	05/94→	16	M 90 14.262 FK	08/95→06/96	16
L 2000 9.225 LC,9.225 LLC, LRC, LLRC (LE220C)	09/00→	19	M 90 14.262 FS,14.262 FLS	08/95→06/96	16
L 2000 9.225 LK, LRK, L-KI, LR-KI (LE220C)	09/00→	19	M 90 14.272 F,14.272 FL	09/91→10/92	31
L 2000 9.225 LLS, LLRS (LE220C)	09/00→	19	M 90 14.272 F,14.272 FL	10/92→06/96	16
LC LC 19.240		22	M 90 14.272 FK	09/91→10/92	31
LC LC 19.280		22	M 90 14.272 FK	10/92→06/96	16
LION S COACH FRH 352,RH 353	09/95→	38	M 90 14.272 FS,14.272 FLS	09/91→10/92	31
LION S COACH FRH 402,RH 403	09/95→	38	M 90 14.272 FS,14.272 FLS	12/92→06/96	16
LION S COACH RH 402	09/98→	38	M 90 17.192 F,17.192 FL	08/88→06/90	11
LION S COACH RH 413	01/00→	43	M 90 17.192 F,17.192 FL	07/90→04/95	16
LION S COACH RH 463	01/00→	51	M 90 17.192 FA	02/89→06/90	11
LION S COACH RHC 414	06/02→	43	M 90 17.192 FA	07/90→06/96	16
LION S COMFORT RN 313	09/96→	38	M 90 17.192 FAK	02/89→06/90	11
LION S COMFORT RN 353	06/97→	38	M 90 17.192 FAK	07/90→06/96	16
LION S STAR FRH 352,RH 353	09/95→	38	M 90 17.192 FK	08/88→06/90	11
LION S STAR FRH 402,RH 403	09/95→	38	M 90 17.192 FK	07/90→01/91	16
LION S STAR FRH 422	01/93→09/96	38	M 90 17.192 FS,17.192 FLS	08/88→06/90	11
LION S STAR RH 414	03/00→	51	M 90 17.192 FS,17.192 FLS	07/90→04/95	16
LION S STAR RH 464, RHS 464	03/00→	43	M 90 17.222 FA	05/94→06/96	16
LION S STAR RH 464, RHS 464	01/02→	51	M 90 17.222 FAK	05/94→06/96	16
M 90 12.152 F,12.152 FL	12/88→05/94	17	M 90 17.232 F,17.232 FL	08/88→04/95	16
M 90 12.152 FK	12/88→05/94	17	M 90 17.232 F,17.232 FL	05/90→04/95	14
M 90 12.152 FS,12.152 FLS	12/88→05/94	17	M 90 17.232 FA	02/89→06/96	16
M 90 12.192 F,12.192 FL	07/90→06/96	16	M 90 17.232 FA	05/90→04/95	14
M 90 12.192 FA	10/92→06/96	16	M 90 17.232 FAK	02/89→06/96	16
M 90 12.192 FAK	10/92→06/96	16	M 90 17.232 FAK	05/90→04/95	14
M 90 12.192 FK	07/90→06/96	16	M 90 17.232 FK	08/88→01/91	16
M 90 12.192 FS,12.192 FLS	07/90→06/96	16	M 90 17.232 FK	05/90→01/91	14
M 90 12.222 F,12.222 FL	05/94→06/96	16	M 90 17.232 FS,17.232 FLS	08/88→04/95	16
M 90 12.222 FA	05/94→06/96	16	M 90 17.232 FS,17.232 FLS	05/90→04/95	14
M 90 12.222 FAK	05/94→06/96	16	M 90 17.272 FLS	09/91→05/95	31
M 90 12.222 FK	05/94→06/96	16	M 90 17.272 FLS	10/92→05/95	16
M 90 12.222 FLS	05/94→06/96	16	M 90 18.192 F,18.192 FL,18.192 FLL	09/90→06/96	16
M 90 12.232 F,12.232 FL	08/88→06/96	16	M 90 18.192 FK	09/90→06/96	16
M 90 12.232 FA	05/90→06/96	16	M 90 18.222 F,18.222 FL,18.222 FLL	05/94→06/96	16
M 90 12.232 FAK	05/90→06/96	16	M 90 18.222 FK	05/94→06/96	16
M 90 12.232 FK	08/88→06/96	16	M 90 18.232 F,18.232 FL,18.232 FLL	09/90→06/96	16
M 90 12.232 FS,12.232 FLS	08/88→06/96	16	M 90 18.232 FK	09/90→06/96	16
M 90 12.262 F,12.262 FL	08/95→06/96	16	M 90 18.262 F,18.262 FL,18.262 FLL	08/95→06/96	16
M 90 12.262 FK	08/95→06/96	16	M 90 18.262 FK	08/95→06/96	16
M 90 12.262 FS,12.262 FLS	08/95→06/96	16	M 90 18.272 F,18.272 FL,18.272 FLL	09/91→05/94	31
M 90 12.272 F,12.272 FL	09/91→10/92	31	M 90 18.272 F,18.272 FL,18.272 FLL	10/92→06/96	16
M 90 12.272 F,12.272 FL	10/92→06/96	16	M 90 18.272 FK	09/91→05/94	31
M 90 12.272 FA	10/93→04/95	16	M 90 18.272 FK	10/92→06/96	16
M 90 12.272 FAK	10/93→04/95	16	M 90 24.192 FNL,24.192 FNLL,24.192 FVL	07/89→06/96	16
M 90 12.272 FK	09/91→10/92	31	M 90 24.222 FNL,24.222 FNLL,24.222 FVL	05/94→06/96	16
M 90 12.272 FK	10/92→06/96	16	M 90 24.232 FNL	05/90→04/95	14
M 90 12.272 FS,12.272 FLS	09/91→10/92	31	M 90 24.232 FNL,24.232 FNLL,24.232 FVL	07/89→06/96	16



21

9

M 90 24.262 FNL, 24.262 FNLL, 24.262 FVL	08/95→06/96	16
M 90 24.272 FNL, 24.272 FNLL, 24.272 FVL	10/92→06/96	16
M 90 24.272 FNL, 24.272 FVL	09/91→05/94	31
M 2000 L 12.163 LC, LLC, LRC, LLRC	08/95→	2
M 2000 L 12.163 LK, LRK	08/95→	2
M 2000 L 12.185 LC, LLC, LRC, LLRC	05/01→	2
M 2000 L 12.224 LC, LLC, LRC, LLRC	08/95→	16
M 2000 L 12.224 LC, LLC, LRC, LLRC	08/95→	19
M 2000 L 12.224, 12.225, LK, LRK	08/95→	16
M 2000 L 12.224, 12.225, LK, LRK	08/95→	19
M 2000 L 12.225 LC, LLC, LLLC, LRC, LLRC	05/01→	19
M 2000 L 14.163 LC, LLC, LRC, LLRC	08/95→	2
M 2000 L 14.163 LK, LRK	08/95→	2
M 2000 L 14.224 LAC, LARC	08/95→	16
M 2000 L 14.224 LAC, LARC	08/95→	19
M 2000 L 14.224 LAK, LARK	08/95→	16
M 2000 L 14.224 LAK, LARK	08/95→	19
M 2000 L 14.224 LC, LLC, LLLC, LRC, LLRC, LLLRC	08/95→	16
M 2000 L 14.224 LC, LLC, LLLC, LRC, LLRC, LLLRC	08/95→	19
M 2000 L 14.224 LK, LRK	08/95→	16
M 2000 L 14.224 LK, LRK	08/95→	19
M 2000 L 14.225 LAC, LARC, (LE220B)	09/00→	19
M 2000 L 14.225 LAK, LARK, (LE220B)	09/00→	19
M 2000 L 14.225 LC, LLC, LLLC, LRC, LLRC, LLLRC, (LE220B)	09/00→	19
M 2000 L 14.225 LK, LRK (LE220B)	09/00→	19
M 2000 L 14.255 LC, LLC, LLLC, LRC, LLRC, LLLRC, (LE250B)	09/00→	19
M 2000 L 14.263, 14.264 LAC, LARC	08/95→	16
M 2000 L 14.263, 14.264 LAK, LARK	08/95→	16
M 2000 L 14.263, 14.264 LC, LLC, LLLC, LRC, LLRC, LLLRC	08/95→	16
M 2000 L 14.263, 14.264 LK, LRK	08/95→	16
M 2000 L 14.284 LC, LLC, LLLC, LRC, LLRC, LLLRC	10/98→	19
M 2000 L 14.284, 14.285, LAC, LARC	06/98→	19
M 2000 L 14.284, 14.285, LAK, LARK	06/98→	19
M 2000 L 14.284, 14.285, LA-LF	06/98→	19
M 2000 L 14.284, 14.285, LK, LRK	10/98→	19
M 2000 L 14.285 LC, LLC, LLLC, LRC, LLRC, LLLRC, (LE280B)	09/00→	19
M 2000 L 15.163 LC, LLC, LRC	08/95→	2
M 2000 L 15.163 LK, LRK	08/95→	2
M 2000 L 15.224 LC, LLC, LLLC, LRC, LLRC, LLLRC	08/95→	16
M 2000 L 15.224 LC, LLC, LLLC, LRC, LLRC, LLLRC	08/95→	19
M 2000 L 15.224 LK, LRK	08/95→	16
M 2000 L 15.224 LK, LRK	08/95→	19
M 2000 L 15.225 LC, LLC, LLLC, LRC, LLRC, LLLRC, (LE220B)	09/99→	19
M 2000 L 15.225 LK, LRK, (LE220B)	09/99→	19
M 2000 L 15.255 LC, LLC, LLLC, LRC, LLRC, LLLRC, (LE250B)	09/99→	19
M 2000 L 15.255 LK, LRK, (LE250B)	09/99→	19
M 2000 L 15.263, 15.264 LC, LLC, LLLC, LRC, LLRC, LLLRC	08/95→	16
M 2000 L 15.263, 15.264 LK, LRK	08/95→	16
M 2000 L 15.284 LC, LLC, LLLC, LRC, LLRC, LLLRC	06/98→	19
M 2000 L 15.284 LK, LRK	06/98→	19
M 2000 L 15.285 LC, LLC, LLLC, LRC, LLRC, LLLRC, (LE280B)	09/99→	19
M 2000 L 15.285 LK, LRK, (LE280B)	09/99→	19
M 2000 L 18.224, 18.225, LAC, LARC	08/95→	16
M 2000 L 18.224, 18.225, LAC, LARC	08/95→	19
M 2000 L 18.224, 18.225, LAK, LARK	08/95→	16
M 2000 L 18.224, 18.225, LAK, LARK	08/95→	19
M 2000 L 18.224, 18.225, LC, LLC, LLLC, LRC, LLRC, LLLRC	08/95→	16
M 2000 L 18.224, 18.225, LC, LLC, LLLC, LRC, LLRC, LLLRC	08/95→	19
M 2000 L 18.224, 18.225, LK, LLK, LRK, LLRK	08/95→	16
M 2000 L 18.224, 18.225, LK, LLK, LRK, LLRK	08/95→	19
M 2000 L 18.255 LAC, LARC	05/01→	19
M 2000 L 18.255 LC, LLC, LLLC, LRC, LLRC, LLLRC, (LE250B)	09/99→	19
M 2000 L 18.263, 18.264, LAC, LARC	08/95→	16
M 2000 L 18.263, 18.264, LAK, LARK	08/95→	16
M 2000 L 18.263, 18.264, LC, LLC, LLLC, LRC, LLRC, LLLRC	08/95→	16
M 2000 L 18.263, 18.264, LK, LLK, LRK, LLRK	08/95→	16
M 2000 L 18.284 LAC, LARC	06/98→	19
M 2000 L 18.284 LAK, LARK	06/98→	19
M 2000 L 18.284 LC, LLC, LLLC, LRC, LLRC, LLLRC	06/98→	19
M 2000 L 18.284, 18.285, LK, LLK, LRK, LLRK	06/98→	19
M 2000 L 18.284, 18.285, L-KO, LR-KO	06/98→	19
M 2000 L 18.285 LAC, LARC (LE280B)	09/99→	19
M 2000 L 18.285 LAK, LARK, (LE280B)	09/99→	19



21

9

M 2000 L 18.285 LC, LLC, LLLC, LRC, LLRC, LLLRC, (LE280B)	09/99→	19
M 2000 L 19.284, 19.285, LLC	05/01→	19
M 2000 M 14.224 MAK	08/95→12/05	16
M 2000 M 14.224 MC, MLC, MLLC	08/95→12/05	16
M 2000 M 14.224 MK	08/95→12/05	16
M 2000 M 14.224 MLS, MLRS	08/95→12/05	16
M 2000 M 14.225 MC, MLC, MLLC	10/00→	19
M 2000 M 14.225 MLS, MLRS	02/03→	19
M 2000 M 14.255 MC, MLC, MLLC	10/00→	19
M 2000 M 14.255 MLS, MLRS	10/00→	19
M 2000 M 14.264 MC, MLC, MLLC	08/95→12/05	16
M 2000 M 14.264 MLS, MLRS	08/95→12/05	16
M 2000 M 14.284 MAK	06/98→12/05	19
M 2000 M 14.284 MA-KO, MA-LF	06/98→12/05	19
M 2000 M 14.284 MC, MLC, MLLC	06/98→12/05	19
M 2000 M 14.284 MLS, MLRS	06/98→12/05	19
M 2000 M 14.285 MLC, MLLC (ME280C)	09/99→12/05	19
M 2000 M 14.285 MLS, MLRS	02/03→	19
M 2000 M 18.224 MAC, MARC	08/95→12/05	16
M 2000 M 18.224 MAK, MARK	08/95→12/05	16
M 2000 M 18.224 MC, MLC, MLLC, MRC, MLRC, MLLRC	08/95→12/05	16
M 2000 M 18.224 MK, 18.224 MLK, MRK, MLRK	08/95→12/05	16
M 2000 M 18.224 MLS, MLRS	08/95→12/05	16
M 2000 M 18.225 MAC, MARC	02/03→	19
M 2000 M 18.225 MC, MLC, MLLC, MRC, MLRC, MLLRC	10/00→	19
M 2000 M 18.255 MAC, MARC	10/00→	19
M 2000 M 18.255 MC, MLC, MLLC, MLRC, MLLRC	10/00→	19
M 2000 M 18.255 MLS, MLRS	10/00→	19
M 2000 M 18.264 MAC, MARC	08/95→12/05	16
M 2000 M 18.264 MAK, MARK	08/95→12/05	16
M 2000 M 18.264 MC, MLC, MLLC, MRC, MLRC, MLLRC	08/95→12/05	16
M 2000 M 18.264 MK, 18.264 MLK, MRK, MLRK	08/95→12/05	16
M 2000 M 18.264 MLS, MLRS	08/95→12/05	16
M 2000 M 18.284 MAC, MARC	06/98→12/05	19
M 2000 M 18.284 MAK, MARK	06/98→12/05	19
M 2000 M 18.284 MC, MLC, MLLC, MRC, MLRC, LLRC	06/98→12/05	19
M 2000 M 18.284 MK, 18.284 MLK, MRK, MLRK	06/98→12/05	19
M 2000 M 18.284 MLS, MLRS	06/98→12/05	19
M 2000 M 18.285 MAC, MARC	02/03→	19
M 2000 M 18.285 MC, MLC, MLLC	06/98→12/05	19
M 2000 M 18.285 MLS, MLRS	02/03→	19
M 2000 M 25.224 MNLC, MNLLC, MNLRC, MNLLRC, MVLC	08/95→12/05	16
M 2000 M 25.224 MNLC, MNLLC, MNLRC, MNLLRC, MVLC	08/95→12/05	19
M 2000 M 25.225 MNLC, MNLLC, MNLRC, MNLLRC, MVLC	02/03→	19
M 2000 M 25.255 MNLC, MNLLC, MNLRC, MNLLRC, MVLC	10/00→	19
M 2000 M 25.264 MNLC, MNLLC, MNLRC, MNLLRC, MVLC	08/95→12/05	16
M 2000 M 25.284 MNLC, MNLLC, MNLRC, MNLLRC, MVLC	02/00→	19
M 2000 M 25.285 MNLC, MNLLC, MNLRC, MNLLRC, MVLC	02/03→	19
Marine	01/76→	57
Marine	01/87→12/90	61
NG NG 262	06/97→07/98	30
NG NG 262, NG 263	07/98→	38
NG NG 262, NG 272	08/92→07/98	16
NG NG 312	09/95→07/98	30
NG NG 312, NG 313	07/98→	38
NL NL 202	09/89→04/94	16
NL NL 202, NL 222, NL 223	08/92→	15
NL NL 202, NL 222, NL 223	08/92→	16
NL NL 202, NL 262, NL 263	04/91→	14
NL NL 243		39
NL NL 262	06/97→	30
NL NL 262, NL 263	07/98→	38
NL NL 312	11/95→07/98	30
NL NL 313	07/98→	38
NM 223	08/87→	16
NM NM 152	05/90→10/93	17
NM NM 152	04/92→03/97	2
NM NM 182, NM 192	05/90→03/97	16
NM NM 222, NM 223	02/96→	15
NM NM 222, NM 223	02/96→	16
NM NM 243		22
NM NM 283		22
NÜ NÜ 263	09/96→07/98	30



21

9



21

9

NÜ NÜ 263	07/98→	16	TGA 18.480 FC, FLC, FLLC, FLLW, FLLRW, FLLRC	09/02→	52
NÜ NÜ 263	07/98→	38	TGA 18.480 FK, 18.480 FLK	09/02→	52
NÜ NÜ 313	07/98→	38	TGA 18.480 FLS, FLLS, FLLS/N, FLS-TS, FLRS-WW	09/02→	52
NÜ NÜ 313 15M	07/98→	38	TGA 18.510 FC, FLC, FRC, FLLC, FLLC/N, FLLW, FLLRC, FLLRW	09/00→	51
NÜ NÜ 353 15M	07/98→	38	TGA 18.510 FLS, FLLS, FLLS/N, FLRS, FLLRS	04/00→	51
R FRH 362	05/85→12/92	41	TGA 18.530 FAC	04/04→	52
R R 292, FR 292, FRH 292	05/85→01/93	38	TGA 18.530 FAK, FALK	04/04→	52
R R 292, FR 292, FRH 292	05/85→01/93	42	TGA 18.530 FAS, FALS	04/04→	52
SD SD 200	04/74→09/75	34	TGA 18.530 FC, FLC, FLLC, FLLC/N, FLLW, FLLRC, FLLRW	09/02→	52
SD SD 200	10/75→04/80	36	TGA 18.530 FLS	09/02→	52
SD SD 200	10/75→11/86	36	TGA 19.360 FS/M-WW, FRS/M-WW	05/04→	43
SD SD 200	06/79→12/86	36	TGA 19.410 FS/M-WW, FRS/M-WW	05/04→	43
SD SD 202	10/85→04/94	36	TGA 19.460 FS/M-WW, FRS/M-WW	05/04→	51
SG SG 220	07/76→04/80	36	TGA 19.480 FS/M-WW, FRS/M-WW	05/04→	52
SG SG 220	05/80→01/85	36	TGA 24.360 FNLLC/N, FNLLW, FNLLRW, FNLLRC	09/01→	43
SG SG 220,SG 240 HÜ,SG 242 H	05/80→01/86	36	TGA 24.410 FNLLC/N, FNLLW, FNLLRW	09/01→	43
SG SG 240 H,SG 242,SG 242 H	09/85→04/94	38	TGA 24.460 FNLLC/N, FNLLW, FNLLRC, FNLLRW	09/01→	51
SG SG 240 H,SG 292 H	11/84→09/89	38	TGA 24.480 FNLLC/N, FNLLW, FNLLRC, FNLLRW	09/02→	52
SG SG 240 HÜ	09/81→01/86	36	TGA 24.480 FPLS, FPLRS	07/05→	52
SG SG 242,SG 292	09/85→04/94	38	TGA 24.510 FNLLC/N, FNLLW, FNLLRW	09/01→	51
SG SG 242,SG 292	09/85→04/94	42	TGA 24.530 FNLLC/N, FNLLW, FNLLRW	09/01→	52
SG SG 312,SG 322	02/94→06/97	30	TGA 24.530 FPLS, FPLRS	07/05→	52
SG SGG 280 H	01/82→	36	TGA 26.280 FNLC, FNLLC, FNLLW	11/02→	22
SL II SL 202	06/84→04/93	36	TGA 26.310 FDAC, FDARC	02/02→	43
SL II SL 202	06/84→04/94	38	TGA 26.310 FDAK	02/02→	43
SL II SL 283		22	TGA 26.310 FDAS, FDARS	02/02→	43
SL SL 200	05/80→01/86	36	TGA 26.310 FDC, FDLC, FDRC, FDLC/M, FDLRC	01/01→	43
SL SL 200	05/80→04/87	36	TGA 26.310 FDK, FDLK, FDRK	09/02→	43
SL SL 200	01/86→04/87	38	TGA 26.310 FDS, FDLS, FDLS/M, FDLRS	01/01→	43
SM SM 152	11/87→04/94	17	TGA 26.310 FD-TM, FDR-TM	10/00→	43
SM SM 182,SM 192	11/87→02/95	16	TGA 26.310 FNLC, FNLLC, FVLC, FNLLW, FNLR, FNLLRW	09/00→	43
SR SR 240	10/75→06/83	36	TGA 26.310 FPLS, FVLS, FNLS, FNLLS, FPLRS, FNLRS, FVLR	12/00→	43
SR SR 280,SR 280 H	01/77→11/86	36	TGA 26.310 FVLC	09/03→	43
SR SR 321 H	03/82→11/86	36	TGA 26.310 FVL-KO	12/00→	43
SÜ SÜ 240	10/75→01/86	36	TGA 26.330 FNLC, FNLLC, FNLLW	11/02→	22
SÜ SÜ 240	05/80→09/89	36	TGA 26.360 FDAC, FDARC	02/02→	43
SÜ SÜ 240	11/82→01/86	36	TGA 26.360 FDAK, FDALK	02/02→	43
SÜ SÜ 240	01/86→09/89	38	TGA 26.360 FDAS, FDARS	02/02→	43
SÜ SÜ 240	01/86→09/89	42	TGA 26.360 FDC, FDLC, FDLC/M, FDRC, FDLRC-WW	01/01→	43
SÜ SÜ 242	01/87→04/93	38	TGA 26.360 FDK, FDLK, FDRK, FDLRK	09/02→	43
SÜ SÜ 243		22	TGA 26.360 FDLS, FDLS/M, FDLRS, FDLRS/M, FDLRS-WW, FDRS	09/03→	43
SÜ SÜ 263		22	TGA 26.360 FDS, FDLS, FNLS, FNLLS, FPLS, FPLRS, FVLS, FVLR	12/00→	43
SÜ SÜ 263	09/03→	39	TGA 26.360 FD-TM, FDR-TM	01/01→	43
SÜ SÜ 272	04/93→05/95	30	TGA 26.360 FNLC, FNLLC, FNLLW, FNLLRC, FNLLRW, FVLC	09/00→	43
SÜ SÜ 283	09/03→	19	TGA 26.360 FVL-KO	12/00→	43
SÜ SÜ 283	09/03→	22	TGA 26.410 FDAC, FDARC	02/02→	43
SÜ SÜ 292	04/92→04/93	42	TGA 26.410 FDAK, FDALK	02/02→	43
SÜ SÜ 313	09/03→	43	TGA 26.410 FDAS, FDALS, FDARS	02/02→	43
SÜ SÜ 322	05/95→06/97	30	TGA 26.410 FDC, FDLC, FDLC/M, FDLC-WW; FDRC-WW, FDLRC-WW	01/01→	43
TGA 18.310 FAC, FARC	09/02→	43	TGA 26.410 FDK, FDRK, FDLK, FDLRK	09/01→	43
TGA 18.310 FAK, FAK-L, FALK	09/02→	43	TGA 26.410 FDS, FDLS, FDLS/M, FDLS-WW, FDRS-WW, FDLRS-WW	06/01→	43
TGA 18.310 FAS, FARS	09/02→	43	TGA 26.410 FD-TM, FDR-TM	01/01→	43
TGA 18.310 FC, FLC, FRC, FLLC, FLLC/N, FLLW, FLLRC, FLLRW	04/00→	43	TGA 26.410 FNLC, FNLLC, FNLLW, FNLR, FNLLRC, FVLC	04/00→	43
TGA 18.310 FK, FLK, FK-L, FLRK	12/00→	43	TGA 26.410 FPLS, FPLRS, FVLS, FNLS, FNLLS	12/00→	43
TGA 18.310 FLS, FLLS, FLLS/N, FLS-TS, FLRS, FLLRS	04/00→	43	TGA 26.410 FVLC	09/03→	43
TGA 18.360 FAC, FARC	09/02→	43	TGA 26.410 FVL-KO	12/00→	43
TGA 18.360 FAK, FALK, FAK-L, FALK-L	09/02→	43	TGA 26.410 FVLS, FVLR	07/05→	43
TGA 18.360 FAS, FALS, FARS	09/02→	43	TGA 26.460 FDC, FDLC, FDLC/M, FDLC-WW, FDRC, FDLRC-WW	01/01→	51
TGA 18.360 FC, FLC, FRC, FLLC, FLLC/N, FLLW, FLLRW	04/00→	43	TGA 26.460 FDK, FDLK, FDLRK	01/01→	51
TGA 18.360 FK, FLK, FK-L, FLRK	12/00→	43	TGA 26.460 FDS, FDLS, FDLS/M, FDLS-WW, FDRS-WW, FDLRS-WW	06/01→	51
TGA 18.360 FLS, FLLS, FLLS/N, FLS-TS, FLRS, FLLRS	04/00→	43	TGA 26.460 FD-TM, FDR-TM	01/01→	51
TGA 18.410 FAC, FARC	09/02→	43	TGA 26.460 FNLC, FNLR, FNLLC, FNLLRW, FNLLRC	04/00→	51
TGA 18.410 FAK, FAK-L, FALK	09/02→	43	TGA 26.460 FPLS, FPLRS, FVLS, FVLR, FNLS, FNLLS, FNLR	12/00→	51
TGA 18.410 FAS, FALS, FARS	09/02→	43	TGA 26.460 FVLC	02/01→	51
TGA 18.410 FC, FRC, FLC, FLRC, FLLC, FLLC/N, FLLW, FLLRC	04/00→	43	TGA 26.460 FVL-KO	12/00→	51
TGA 18.410 FK, FK-L, FLK, FLRK	12/00→	43	TGA 26.480 FDAC, FDALC, FDARC	09/02→	52
TGA 18.410 FLS, FLLS, FLLS/N, FLS-TS, FLRS, FLLRS	04/00→	43	TGA 26.480 FDAK, FDALK	09/02→	52
TGA 18.460 FC, FLC, FRC, FLLC, FLLC/N, FLLW, FLLRC, FLLRW	04/00→	51	TGA 26.480 FDAS, FDALS, FDARS	09/02→	52
TGA 18.460 FK, FK-L, FLK, FLRK	12/00→	51	TGA 26.480 FDC, FDLC, FDLC/M, FDLC-WW, FDRC, FDLRC-WW	09/02→	52
TGA 18.460 FLS, FLLS, FLLS/N, FLS-TS, FLRS, FLLRS	04/00→	51	TGA 26.480 FDK, FDLK, FDLRK	09/02→	52
TGA 18.480 FAC, FARC	09/02→	52	TGA 26.480 FDS, FDLS, FDLS/M, FDLRS-WW, FDRS	09/02→	52
TGA 18.480 FAK, FAK-L, FALK	09/02→	52	TGA 26.480 FD-TM	09/02→	52
TGA 18.480 FAS, FALS, FARS	09/02→	52	TGA 26.480 FNLC, FNLLC, FVLC, FNLLRC, FVLLW	09/02→	52



21

9

TGA 26.480 FNLS, FNLLS, FNLRS, FPLS, FVLS	09/02→	52
TGA 26.480 FVLC	09/02→	52
TGA 26.510 FDC, FDC/M, FDRC, FDLC, FDLC/M, FDLRC	01/01→	51
TGA 26.510 FDS, FDLS, FDLS/M, FDRS, FDLRS	01/01→	51
TGA 26.510 FNLC, FNLLC, FNLLW, FNLLRC, FVLC	12/00→	51
TGA 26.510 FNLS, FNLLS, FNLRS, FPLS, FVLS	12/00→	51
TGA 26.530 FDAC, FDALC	07/06→	52
TGA 26.530 FDAK, FDALK	09/02→	52
TGA 26.530 FDAS, FDALS	07/06→	52
TGA 26.530 FDC, FDLC, FDC/M, FDLRC	01/01→	52
TGA 26.530 FDK, FDLK, FDLRK	09/02→	52
TGA 26.530 FDS, FDLS, FDLS/M, FDLRS	01/01→	52
TGA 26.530 FNLC, FNLLC, FNLLW, FNLLRC, FVLC, FVLC	09/02→	52
TGA 26.530 FNLS, FNLLS, FNLRS, FPLS, FVLS, FVLS	09/02→	52
TGA 28.310 FNLC, FNLLC	09/02→	43
TGA 28.310 FNLC, FNLLC, FNLRC	09/02→	43
TGA 28.310 FNLS, FNLRS	09/02→	43
TGA 28.360 FANLC	07/06→	43
TGA 28.360 FANLK	07/06→	43
TGA 28.360 FNLC, FNLLC	09/02→	43
TGA 28.360 FNLS, FNLRS	09/02→	43
TGA 28.390 FNLLC	07/06→	52
TGA 28.410 FANLC	07/06→	43
TGA 28.410 FANLK	07/06→	43
TGA 28.410 FNLC, FNLLC	09/02→	43
TGA 28.410 FNLC, FNLLC, FNLRC	09/02→	43
TGA 28.410 FNLS, FNLRS	09/02→	43
TGA 28.460 FNLC, FNLLC, FNLRC	09/02→	51
TGA 28.460 FNLS, FNLRS	09/02→	51
TGA 28.480 FANLC	07/06→	52
TGA 28.480 FANLK	07/06→	52
TGA 28.480 FNLC, FNLLC, FNLRC	09/02→	52
TGA 28.480 FNLS, FNLRS	09/02→	52
TGA 28.510 FNLC, FNLLC, FNLRC	09/02→	51
TGA 28.510 FNLS, FNLRS	09/02→	51
TGA 28.530 FANLC	07/06→	52
TGA 28.530 FANLK	07/06→	52
TGA 28.530 FNLC, FNLLC, FNLRC	09/02→	52
TGA 28.530 FNLS, FNLRS	09/02→	52
TGA 32.310	01/02→	43
TGA 32.310 FFDC, FFDLC, FFDLRC	01/02→	43
TGA 32.310 FFDK, FFDLK	01/02→	43
TGA 32.360 FFDC, FFDLC, FFDLRC	01/02→	43
TGA 32.360 FFDK, FFDLK	01/02→	43
TGA 32.360 FFD-TM	01/02→	43
TGA 32.410 FFDC, FFDLC, FFDRC, FFDLRC	01/02→	43
TGA 32.410 FFDK, FFDLK	01/02→	43
TGA 32.410 FFD-TM	01/02→	43
TGA 32.460 FFDC, FFDLC, FFDLRC	01/02→	51
TGA 32.460 FFDK, FFDLK	01/02→	51
TGA 32.460 FFD-TM	01/02→	51
TGA 32.480 FFDC, FFDLC, FFDLRC	09/02→	52
TGA 32.480 FFDK, FFDLK	09/02→	52
TGA 32.480 FFD-TM	09/02→	52
TGA 33.360 FDAC, FDARC, FDAC-WW	09/02→	43
TGA 33.360 FDAK, FDAK-WW	09/02→	43
TGA 33.360 FDAS, FDAS-WW	09/02→	43
TGA 33.360 FDC, FDC-WW, FDLC/M, FDRC-WW, FDLRC	10/00→	43
TGA 33.360 FDK, FDK-WW, FDLK, FDRK-WW	01/01→	43
TGA 33.360 FDS, FDS-WW, FDLS, FDLRS, FDRS-WW	10/00→	43
TGA 33.360 FD-TM, FDR-TM	01/01→	43
TGA 33.410 FDAC, FDAC-WW, FDALC	09/02→	43
TGA 33.410 FDAK, FDAK-WW, FDALK	09/02→	43
TGA 33.410 FDAS, FDAS-WW, FDALS	09/02→	43
TGA 33.410 FDC, FDC-WW, FDLC, FDLRC, FDRC-WW	10/00→	43
TGA 33.410 FDK, FDK-WW, FDLK, FDRK-WW	10/00→	43
TGA 33.410 FDS, FDS-WW, FDLS, FDLS/M, FDLRS, FDRS-WW	10/00→	43
TGA 33.410 FD-TM, FDR-TM	10/00→	43
TGA 33.460 FDAC-WW	09/02→	51
TGA 33.460 FDAK-WW	09/02→	51
TGA 33.460 FDAS-WW	09/02→	51
TGA 33.460 FDC, FDC-WW, FDLC, FDLRC, FDRC-WW	09/02→	51
TGA 33.460 FDK, FDK-WW, FDLK, FDRK-WW	09/02→	51



21

9

TGA 33.460 FDS, FDLS, FDLS/M, FDLRS, FDRS-WW	09/02→	51
TGA 33.460 FD-TM, FDR-TM	09/02→	51
TGA 33.480 FDAC, FDAC-WW, FDALC, FDARC	09/02→	52
TGA 33.480 FDAK, FDAK-WW, FDALK	09/02→	52
TGA 33.480 FDAS, FDAS-WW, FDARS, FDALS	09/02→	52
TGA 33.480 FDC, FDC-WW, FDLC, FDRC-WW, FDLRC	09/02→	52
TGA 33.480 FDK, FDK-WW, FDLK, FDRK-WW	09/02→	52
TGA 33.480 FDS, FDS-WW, FDLS, FDLS/M, FDRS-WW, FDLRS	09/02→	52
TGA 33.480 FD-TM	09/02→	52
TGA 33.510 FDC, FDC/M, FDLC, FDRC, FDLRC	09/02→	51
TGA 33.510 FDS, FDLS/M, FDRS, FDLRS/M	09/02→	51
TGA 33.530 FDAC, FDALC	09/02→	52
TGA 33.530 FDAK, FDALK	09/02→	52
TGA 33.530 FDAS, FDALS	09/02→	52
TGA 33.530 FDC, FDC/M, FDLC, FDRC, FDLRC	09/02→	52
TGA 33.530 FDK, FDLK	07/03→	52
TGA 33.530 FDS, FDLS, FDLS/M, FDRS, FDLRS	07/03→	52
TGA 35.310 FFDK, FFDLK	06/03→	43
TGA 35.310 FFD-TM	11/03→	43
TGA 35.360 FFDC, FFDLC	10/03→	43
TGA 35.360 FFDK, FFDLK	10/03→	43
TGA 35.360 FFD-TM	11/03→	43
TGA 35.360 FFNLC	07/06→	43
TGA 35.410 FDNLC	07/06→	43
TGA 35.410 FDDAK	07/06→	43
TGA 35.410 FFDK, FFDLC	10/03→	43
TGA 35.410 FFDK, FFDLK	10/03→	43
TGA 35.410 FFD-TM	11/03→	43
TGA 35.410 FFNLC	07/06→	43
TGA 35.460 FFDC, FFDLC	10/03→	51
TGA 35.460 FFDK, FFDLK	10/03→	51
TGA 35.460 FFD-TM	11/03→	51
TGA 35.460 FFNLC	07/06→	51
TGA 35.480 FDNLC	07/06→	52
TGA 35.480 FDDAK	07/06→	52
TGA 35.480 FDDARS	07/06→	52
TGA 35.480 FFDC, FFDLC	10/03→	52
TGA 35.480 FFDK, FFDLK	10/03→	52
TGA 35.480 FFD-TM	11/03→	52
TGA 35.530 FDNLC	04/04→	52
TGA 35.530 FDDAK	07/06→	52
TGA 35.530 FFDC, FFDLC	04/04→	52
TGA 35.530 FFDK, FFDLK	04/04→	52
TGA 35.530 FFD-TM	04/04→	52
TGA 35.530 FFNLC	07/06→	52
TGA 37.310 FFDC	12/04→	43
TGA 37.310 FFDK	12/04→	43
TGA 37.310 FFD-TM	12/04→	43
TGA 37.360 FFDC	12/04→	43
TGA 37.360 FFDK	12/04→	43
TGA 37.360 FFD-TM	12/04→	43
TGA 37.410 FFDC	12/04→	43
TGA 37.410 FFDK	12/04→	43
TGA 37.410 FFD-TM	12/04→	43
TGA 37.460 FFDC	12/04→	51
TGA 37.460 FFDK	12/04→	51
TGA 37.460 FFD-TM	12/04→	51
TGA 37.480 FFDC	12/04→	52
TGA 37.480 FFDK	12/04→	52
TGA 37.480 FFD-TM	12/04→	52
TGA 37.530 FFDC	12/04→	52
TGA 37.530 FFDK	12/04→	52
TGA 37.530 FFD-TM	12/04→	52
TGA 37.530 FVDS, FVDLS	07/06→	52
TGA 40.410 FDAK-WW	04/04→	43
TGA 40.410 FDAS-WW	04/04→	43
TGA 40.410 FDK-WW	04/04→	43
TGA 40.410 FDS-WW	04/04→	43
TGA 40.460 FDAK-WW	04/04→	51
TGA 40.460 FDAS-WW	04/04→	51
TGA 40.460 FDK-WW	04/04→	51



21

9

TGA 40.460 FDS-WW	04/04→	51
TGA 40.480 FDAK-WW	04/04→	52
TGA 40.480 FDAS-WW	04/04→	52
TGA 40.480 FDK-WW	04/04→	52
TGA 40.480 FDS-WW	04/04→	52
TGA 41.360 FFDC, FFDC/M, FFDC/M-WW, FFDC	01/03→	43
TGA 41.360 FFDK-WW	09/03→	43
TGA 41.360 FFD-TM	12/04→	43
TGA 41.410 FFDK	07/06→	43
TGA 41.410 FFDC-WW, FDRK	09/03→	43
TGA 41.410 FFDK-WW	09/03→	43
TGA 41.410 FFD-TM	12/04→	43
TGA 41.460 FFDC-WW, FFDC	09/03→	51
TGA 41.460 FFDK-WW	09/03→	51
TGA 41.460 FFD-TM	12/04→	51
TGA 41.480 FFDK	07/06→	52
TGA 41.480 FFDARC	07/06→	52
TGA 41.480 FFDC-WW, FFDC	06/05→	52
TGA 41.480 FFDK-WW	06/05→	52
TGA 41.480 FFD-TM	12/04→	52
TGA 41.480 FVDS, FVDLS	07/06→	52
TGA 41.530 FFDK	07/06→	52
TGA 41.530 FFDC	12/04→	52
TGA 41.530 FFDK	12/04→	52
TGA 41.530 FFD-TM	12/04→	52
TGA 41.530 FVDS, FVDLS	09/02→	52
TGA 41.660 FVDS	09/02→	60
TGL 7.150, 8.150 FC, FRC, FLC, FLRC	04/05→	6
TGL 7.180 FC, FLC, FRC, FLRC	04/05→	6
TGL 8.150 FK, FRK, FK-L, FRK-L	10/06→	6
TGL 8.180 FC, FRC, FLC, FLRC	04/05→	6
TGL 8.180 FK, FK-L, FRK, FRK-L	04/05→	6
TGL 8.210 FC, FRC, FLC, FLRC	04/05→	6
TGL 8.210 FK, FK-L, FRK, FRK-L	04/05→	6
TGL 8.240 FC, FRC, FLC, FLRC	04/05→	22
TGL 8.240 FK, FK-L, FRK, FRK-L	04/05→	22
TGL 10.180 FC, FRC, FLC, FLRC	04/05→	6
TGL 10.180 FK, FRK	04/05→	6
TGL 10.210 FC, FRC, FLC, FLRC	04/05→	6
TGL 10.210 FK, FRK	04/05→	6
TGL 10.240 FC, FRC, FLC, FLRC	04/05→	22
TGL 10.240 FK, FRK	04/05→	22
TGL 12.180 FC, FRC, FLC, FLRC	04/05→	6
TGL 12.180 FK, FRK	04/05→	6
TGL 12.210 FC, FRC, FLC, FLRC	04/05→	6
TGL 12.210 FK, FRK	04/05→	6
TGL 12.240 FC, FRC, FLC, FLRC	04/05→	22
TGL 12.240 FK, FRK	04/05→	22
TGM 12.240 FLC, FLLC	10/05→	22
TGM 12.280 FC, FLC, FLLC	10/05→	22
TGM 13.240 FAL, FALC, FALRC, FAEC, FAERC, FALR	04/06→	22
TGM 13.240 FALK, FALRK, FALK-L, FALRK-L	04/06→	22
TGM 13.280 FAEC, FAERC, FAL, FALC, FALRC	04/06→	22
TGM 13.280 FALK, FALRK, FALK-L, FALRK-L	04/06→	22
TGM 15.240 FC, FLC, FLLC, FLRC, FLLRC	10/05→	22
TGM 15.240 FLK, FLRK	10/05→	22
TGM 15.280 FC, FLC, FLLC, FLRC, FLLRC	10/05→	22
TGM 15.280 FLK, FLRK	10/05→	22
TGM 15.330 FC, FLC, FRC, FLRC	10/05→	22
TGM 15.330 FLK, FLRK	10/05→	22
TGM 18.240 FAC, FARC	10/05→	22
TGM 18.240 FAK, FARK	05/06→	22
TGM 18.240 FC, FRC, FLC, FLRC, FLLC, FLLRC	10/05→	22
TGM 18.240 FK, FRK, FLK, FK-L, FLRK	10/05→	22
TGM 18.280 FAC, FARC	10/05→	22
TGM 18.280 FAK, FARK	10/05→	22
TGM 18.280 FC, FRC, FLC, FLRC, FLLC, FLLRC	10/05→	22
TGM 18.280 FK, FLK, FRK, FLRK, FK-L	10/05→	22
TGM 18.330 FAC, FARC	10/05→	22
TGM 18.330 FAK, FARK	10/05→	22
TGM 18.330 FC, FRC, FLC, FLRC, FLLC, FLLRC	10/05→	22
TGM 18.330 FK, FLK, FRK, FLRK, FK-L	10/05→	22
TGM 22.240 FNLLC	10/05→	22



21

9

TGM 22.280 FNLLC	10/05→	22
TGM 26.280 FD	10/05→	22
TGM 26.280 FDK, FDRK-HK	04/06→	22
TGM 26.280 FDR-TM	04/06→	22
TGM 26.280 FNLC, FNLLC, FNLRC, FNLLRC	10/05→	22
TGM 26.330 FD, FDR	10/05→	22
TGM 26.330 FDK, FDRK-HK	04/06→	22
TGM 26.330 FDR-TM	04/06→	22
TGM 26.330 FNLC, FNLLC, FNLRC, FNLLRC	10/05→	22
ÜL ÜL 242	09/89→03/93	38
ÜL ÜL 272	03/93→	30
ÜL ÜL 292	09/89→03/93	38
ÜL ÜL 312, ÜL 322	04/92→09/96	30
ÜL ÜL 313	09/96→	38
ÜL ÜL 353	06/97→	38



cc



kW/PS

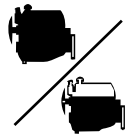

1	D 0224 ME	3790	4	102.00		58-66/ 79-90		DG640 ■○ (x2)					
	D 0224 M/D 0224 MF	3790	4	102.00		66/90							
2	D 0824 FLO1	4580	4	108.00	Euro 1/Turbo Intercooled	75/102	BV500 (SE) (x2)	DV500 ○ (x2)					
	D 0824 GF03/D 0824 GF04	4580	4	108.00	Euro 1	75/102							
	D 0824 LFL04	4580	4	108.00	Euro 2/Turbo Intercooled	81/110							
	D 0824 LUE 523	4580	4	108.00	Turbo Intercooled	81/110							
	D 0824 LFL08	4580	4	108.00	Euro 2/Turbo Intercooled	83/113							
	D 0824 LFL10	4580	4	108.00	Euro 2/Turbo Intercooled	92-162/ 125-220							
	D 0824 LUE 522	4580	4	108.00	Turbo Intercooled	92/125							
	D 0824 LUE 521	4580	4	108.00	Turbo Intercooled	103/140							
	D 0834 LFL01/D 0834 LFL02	4580	4	108.00	Euro 3/Turbo Intercooled	103/140							
	D 0824 LFL07	4580	4	108.00	Euro 2/Turbo Intercooled	104/141							
	D 0824 LFO1	4580	4	108.00	Euro 1/Turbo Intercooled	114/155							
	D 0824 LFG 01	4580	4	108.00	Euro 2/Turbo Intercooled	114/155							
	D 0824 LFL01	4580	4	108.00	Euro 1/Turbo Intercooled	114/155							
	D 0824 LFL03	4580	4	108.00	Euro 2/Turbo Intercooled	114/155							
	D 0824 LFL05	4580	4	108.00	Euro 1/Turbo Intercooled	114/155							
	D 0824 LFL06	4580	4	108.00	Euro 2/Turbo Intercooled	114/155							
	D 0824 LFL09/ D 0824 LFO 01/ D 0824 LOH01/ D 0824 LOH02/ D 0824 LOH03/ D 0824 LOH04	4580	4	108.00	Euro 1/Turbo Intercooled	114/155							
	D 0824 LOH05	4580	4	108.00	Euro 2/Turbo Intercooled	114/155							
	D 0824 LFO2	4580	4	108.00	Euro 2/Turbo Intercooled	118/160							
	D 0824 LFO3/D 0824 LFO4/ D 0824 LFO5/D 0824 LFO6/ D 0824 LFO7/D 0824 LFO8/ D 0824 LFO9/D 0824 LFO10	4580	4	108.00	Euro 1/Turbo Intercooled	118/160							
	D 0824 LFL02	4580	4	108.00	Euro 2/Turbo Intercooled	118/160							
	D 0824 LFO02	4580	4	108.00	Turbo Intercooled	118/160							
	D 0834 LFL20/ D 0834 LOH01/ D 0834 LOH02/ D 0834 LOH03	4580	4	108.00	Euro 3/Turbo Intercooled	125/170							
	D 0834 LFL03	4580	4	108.00	Euro 3/Turbo Intercooled	132/180							
	3	D 0824 GF/D 0824 GF01	4580	4	108.00					75/102	BV500 (SE) (x2)	DV500 ○ (x2)	GV500
		D 0824 GF02	4580	4	108.00	Euro 1				75/102			
	4	D 0824 LFO	4580	4	108.00	Euro 1/Turbo Intercooled				118/160		DG640 ■○ (x2)	
	5	D 0834 LFL04	4581	4	108.00	Euro 3/Turbo Intercooled				110/150	BV500 (SE) (x2)	DV500 ○ (x2)	

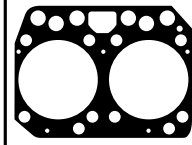
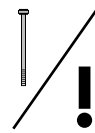
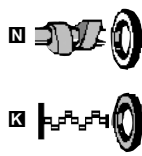
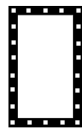
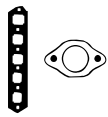

BV500

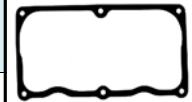

JM354



JJ542

JD118 (x4) JD124 (x4)	JM354 (x2)	JJ542		<input checked="" type="checkbox"/> NB964 60.4x80x12mm, FPM <input checked="" type="checkbox"/> NA5181 110x130x13mm, PTFE	
JD118 (x4) JD124 (x4)	JM354 (x2)	JJ542	HR775	<input checked="" type="checkbox"/> NA5156 66x90x12mm, PTFE <input checked="" type="checkbox"/> NB967 66x90x12mm, FPM <input checked="" type="checkbox"/> NA5181 110x130x13mm, PTFE <input checked="" type="checkbox"/> NF754 110x130x12mm, FPM	HBS473 [8] M14x2x140,0mm (x8)
JD118 (x4) JD124 (x4)	JM354 (x2)	JJ542	HR775	<input checked="" type="checkbox"/> NA5156 66x90x12mm, PTFE <input checked="" type="checkbox"/> NB967 66x90x12mm, FPM <input checked="" type="checkbox"/> NA5181 110x130x13mm, PTFE <input checked="" type="checkbox"/> NF754 110x130x12mm, FPM	HBS473 [8] M14x2x140,0mm (x8)
JD118 (x4) JD124 (x4)		JJ490		<input checked="" type="checkbox"/> NB967 66x90x12mm, FPM <input checked="" type="checkbox"/> NA5156 66x90x12mm, PTFE <input checked="" type="checkbox"/> NA5181 110x130x13mm, PTFE <input checked="" type="checkbox"/> NF754 110x130x12mm, FPM	
JD118 (x4) JD124 (x4)	JM354 (x2)	JJ542	HR775	<input checked="" type="checkbox"/> NA5156 66x90x12mm, PTFE <input checked="" type="checkbox"/> NB967 66x90x12mm, FPM <input checked="" type="checkbox"/> NA5181 110x130x13mm, PTFE <input checked="" type="checkbox"/> NF754 110x130x12mm, FPM	HBS473 [8] M14x2x140,0mm (x8)



cc



kW/PS

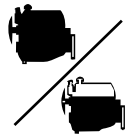

6	D 0834 LFL40	4581	4	108.00	Euro 3/Turbo Intercooled	110/150	BV500 (SE) (x2)						
	D 0834 LFL50/D 0834 LFL53	4581	4	108.00	Euro 4/Turbo Intercooled	110/150							
	D 0834 LFL41	4581	4	108.00	Euro 3/Turbo Intercooled	132/180							
	D 0834 LFL51/ D 0834 LFL54/ D 0834 LOH50/ D 0834 LOH52	4581	4	108.00	Euro 4/Turbo Intercooled	132/180							
	D 0834 LFL42	4581	4	108.00	Euro 3/Turbo Intercooled	151/206							
	D 0834 LFL52/ D 0834 LFL55/ D 0834 LOH51/ D 0834 LOH53	4581	4	108.00	Euro 4/Turbo Intercooled	151/206							
	7	D 0226 M/D 0226 ME/ D 0226 MFA/D 0226 MFM D 0226 MTE	5687	6	102.00	Euro 3/Turbo				66-100/ 90-136		DG640 ■○ (x3)	
		D 0226 MFO/D 0226 MH	5687	6	102.00					81-135/ 110-184			
		D 0226 MF	5687	6	102.00					90-100/ 122-136			
		D 0226 MKFO	5687	6	102.00					Turbo Intercooled			
D 0226 MT		5687	6	102.00	Turbo		110-135/ 150-184						
D 0226 MC/D 0226 MK/ D 0226 MKFA/D 0226 ML/ D 0226 MLE		5687	6	102.00	Turbo Intercooled		125-154/ 170-209						
D 0226 MKH		5687	6	102.00	Turbo Intercooled		125-154/ 170-209						
8		D 0226 MCF0/170	5687	6	102.00		Turbo Intercooled	125/170	AH5440 (SE) (x3)	CH5440			
9	D 0226 MKF/170	5687	6	102.00	Turbo Intercooled	125/170	AH5440 (SE) (x3)	CH5440					
	D 0226 MKF	5687	6	102.00	Turbo Intercooled	141/192							
10	D 0826 TOH 01	6596	6	108.00	Turbo	130/177	BV500 (SE) (x3)	DV500 ○ (x3)	GV502 ○				
11	D 0826 TOH	6596	6	108.00	Turbo	132-137/ 180-186	BV500 (SE) (x3)	DV500 ○ (x3)	EV500 GV502 ○				
	D 0826 TF	6596	6	108.00	Turbo	137/186							
12	D 0826	6867	6	108.00	Turbo Intercooled	198/270	BV500 (SE) (x3)	DV500 ○ (x3)	EV500 GV502 ○				
13	D 0826 LUE51	6870	6	108.00	Euro 1/Turbo Intercooled/Boxer	132/180	BV500 (SE) (x3)	DV500 ○ (x3)	GV502 ○				
14	D 0826 LF/217/Silent	6870	6	108.00	Turbo Intercooled	160/218	BV500 (SE) (x3)	DV500 ○ (x3)	EV500 GV502 ○				
	D 0826 LUH	6870	6	108.00	Euro 1/Turbo Intercooled/Boxer	184/250							
15	D 0826 LUH12	6870	6	108.00	Euro 1/Turbo Intercooled	162/220	BV500 (SE) (x3)	DV500 ○ (x3)	EV501 GV502 ○				

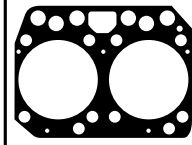
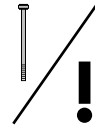
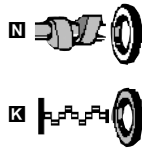
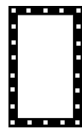
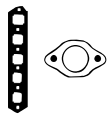

BV500



JM354

				<input checked="" type="checkbox"/> NA5156 66x90x12mm, PTFE <input checked="" type="checkbox"/> NB967 66x90x12mm, FPM <input checked="" type="checkbox"/> NA5181 110x130x13mm, PTFE <input checked="" type="checkbox"/> NF754 110x130x12mm, FPM	HBS472 [8] M14x2x152mm (x8)
JD118 (x4) JD124 (x6)		JJ490		<input checked="" type="checkbox"/> NB964 60.4x80x12mm, FPM <input checked="" type="checkbox"/> NA5181 110x130x13mm, PTFE <input checked="" type="checkbox"/> NF754 110x130x12mm, FPM	
JD118 (x6) JD124 (x6)		JJ490		<input checked="" type="checkbox"/> NA5156 66x90x12mm, PTFE <input checked="" type="checkbox"/> NB964 60.4x80x12mm, FPM <input checked="" type="checkbox"/> NA5181 110x130x13mm, PTFE <input checked="" type="checkbox"/> NF754 110x130x12mm, FPM	
JD118 (x6) JD124 (x6)		JJ490		<input checked="" type="checkbox"/> NB964 60.4x80x12mm, FPM <input checked="" type="checkbox"/> NA5181 110x130x13mm, PTFE <input checked="" type="checkbox"/> NF754 110x130x12mm, FPM	
JD118 (x6) JD124 (x6)	JM354 (x3)	JJ490	HR775	<input checked="" type="checkbox"/> NA5156 66x90x12mm, PTFE <input checked="" type="checkbox"/> NB967 66x90x12mm, FPM <input checked="" type="checkbox"/> NA5181 110x130x13mm, PTFE <input checked="" type="checkbox"/> NF754 110x130x12mm, FPM	HBS473 [8] M14x2x140,0mm (x8)
JD118 (x6) JD124 (x6)	JM354 (x3)	JJ490	HR775	<input checked="" type="checkbox"/> NB967 66x90x12mm, FPM <input checked="" type="checkbox"/> NF754 110x130x12mm, FPM <input checked="" type="checkbox"/> NA5156 66x90x12mm, PTFE <input checked="" type="checkbox"/> NA5181 110x130x13mm, PTFE	HBS473 [8] M14x2x140,0mm (x8)
JD118 (x6) JD124 (x6)	JM354 (x3)	JJ490	HR775	<input checked="" type="checkbox"/> NB967 66x90x12mm, FPM <input checked="" type="checkbox"/> NF754 110x130x12mm, FPM <input checked="" type="checkbox"/> NA5156 66x90x12mm, PTFE <input checked="" type="checkbox"/> NA5181 110x130x13mm, PTFE	HBS473 [8] M14x2x140,0mm (x8)
JD118 (x6) JD124 (x6)	JM354 (x3)	JJ490	HR775	<input checked="" type="checkbox"/> NA5156 66x90x12mm, PTFE <input checked="" type="checkbox"/> NB967 66x90x12mm, FPM <input checked="" type="checkbox"/> NA5181 110x130x13mm, PTFE <input checked="" type="checkbox"/> NF754 110x130x12mm, FPM	HBS473 [8] M14x2x140,0mm (x8)
JD118 (x6) JD124 (x6)	JM354 (x3)	JJ490	HR775	<input checked="" type="checkbox"/> NB967 66x90x12mm, FPM <input checked="" type="checkbox"/> NF754 110x130x12mm, FPM <input checked="" type="checkbox"/> NA5156 66x90x12mm, PTFE <input checked="" type="checkbox"/> NA5181 110x130x13mm, PTFE	HBS473 [8] M14x2x140,0mm (x8)
JD118 (x6) JD124 (x6)	JM354 (x3)	JJ490	HR775	<input checked="" type="checkbox"/> NA5156 66x90x12mm, PTFE <input checked="" type="checkbox"/> NB967 66x90x12mm, FPM <input checked="" type="checkbox"/> NA5181 110x130x13mm, PTFE <input checked="" type="checkbox"/> NF754 110x130x12mm, FPM	HBS473 [8] M14x2x140,0mm (x8)



cc



Ø



kW/PS

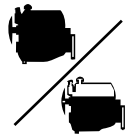

16

D 0826 OH03	6871	6	108.00	Euro 1	107/146
D 0826 GF03	6871	6	108.00		110/150
D 0826 GF04	6871	6	108.00	Euro 1	110-114/ 150-155
D 0826 OH	6871	6	108.00		110/150
D 0826 LFL05	6871	6	108.00	Euro 1/Turbo Intercooled	114/155
D 0826 OH01	6871	6	108.00		114/155
D 0826 LE51/D 0826 LE52	6871	6	108.00	Turbo Intercooled	132/180
D 0826 TUE 51	6871	6	108.00	Turbo Intercooled	132/ 180-180
D 0826 LF01/D 0826 LF05	6871	6	108.00	Turbo Intercooled	140/190
D 0826 LF07	6871	6	108.00	Euro 1/Turbo Intercooled	140/190
D 0826 LF12	6871	6	108.00	Euro 2/Turbo Intercooled	140/190
D 0826 LOH01/D 0826 LOH02	6871	6	108.00	Turbo Intercooled	140/190
D 0826 LOH06/D 0826 LOH11	6871	6	108.00	Euro 1/Turbo Intercooled	140/190
D 0826 LOH12	6871	6	108.00	Turbo Intercooled	140/190
D 0826 LF10	6871	6	108.00	Euro 2/Turbo Intercooled	142-169/ 193-230
D 0826 LOH13	6871	6	108.00	Euro 1/Turbo Intercooled	151/205
D 0826 LUH	6871	6	108.00	Turbo Intercooled	157/213
D 0826 LUH03	6871	6	108.00	Euro 1/Turbo Intercooled	157/214
D 0826 LUH04	6871	6	108.00	Turbo Intercooled	157-169/ 214-230
D 0826 LF11/D 0826 LF15/ D 0826 LF18	6871	6	108.00	Euro 2/Turbo Intercooled	162/220
D 0826 LFL/D 0826 LFL03/ D 0826 LFL06/D 0826 LFL08	6871	6	108.00	Euro 1/Turbo Intercooled	162/220
D 0826 LOH15/D 0826 LOH19	6871	6	108.00	Euro 2/Turbo Intercooled	162/220
D 0826 LUH08	6871	6	108.00	Euro 2/Turbo Intercooled	162-169/ 220-230
D 0836 LFL06/ D 0836 LFL07/D 0836 LFL10	6871	6	108.00	Euro 3/Turbo Intercooled	162/220
D 0826 FG001	6871	6	108.00		169/230
D 0826 LF02	6871	6	108.00	Euro 1/Turbo Intercooled	169/230
D 0826 LF06	6871	6	108.00	Turbo Intercooled	169/230
D 0826 LF08/D 0826 LF09	6871	6	108.00	Euro 1/Turbo Intercooled	169/230
D 0826 LOH05	6871	6	108.00	Turbo Intercooled	169/230
D 0826 LOH07/D 0826 LOH09	6871	6	108.00	Euro 1/Turbo Intercooled	169/230
D 0826 LUH02	6871	6	108.00	Euro 1/Turbo Intercooled	169-198/ 230-269
D 0826 LUH05	6871	6	108.00	Euro 1/Turbo Intercooled	169/230
D 0826 LUH06/D 0826 LUH10	6871	6	108.00	Euro 1/Turbo Intercooled	169-198/ 230-269
D 0826 LFL07	6871	6	108.00	Euro 1/Turbo Intercooled	188/256
D 0826 LF13/D 0826 LF17/ D 0826 LFL09/ D 0826 LOH18/ D 0826 LUH13	6871	6	108.00	Euro 2/Turbo Intercooled	191/260
D 0826 LOH08	6871	6	108.00	Euro 1/Turbo Intercooled	198/269
D 0826 LF04/D 0826 LUH01	6871	6	108.00	Euro 1/Turbo Intercooled	198/270

BV500 (SE) (x3)
DV500 ○ (x3)

EV500
GV502 ○

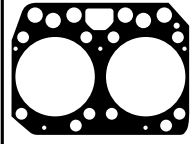
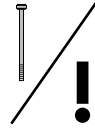
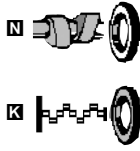
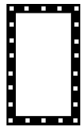
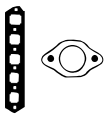

BV500







JM354



JD118  (x6)
JD124  (x6)

JM354 (x3)

JJ490

HR775 

NA5156  66x90x12mm, PTFE
 NB967  66x90x12mm, FPM
 NA5181  110x130x13mm, PTFE
 NF754  110x130x12mm, FPM

HBS473  [8] 
M14x2x140,0mm (x8)



cc



kW/PS

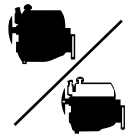

17	D 0826 F01	6871	6	108.00		110-114/ 150-155	BV500 (SE) (x3)	DV500 ○ (x3)	EV500 GV501 ○				
	D 0826 F02/D 0826 F0 O2	6871	6	108.00		110/150							
	D 0826 GF	6871	6	108.00	Turbo	110-114/ 150-155							
	D 0826 GF01	6871	6	108.00	Euro 1	110-114/ 150-155							
	D 0826 OH02	6871	6	108.00		110-114/ 150-155							
	D 0826 FO 01	6871	6	108.00		114/155							
	D 0826	6871	6	108.00		125/170							
	D 0826 LUH11	6871	6	108.00	Euro 2/Turbo Intercooled	162/220							
	D 0826 LUH09	6871	6	108.00	Euro 2/Turbo Intercooled	169-206/ 230-280							
18	D 0826 GFA	6871	6	108.00		114/155	BV500 (SE) (x3)	DV500 ○ (x3)					
	D 0826 LE 524	6871	6	108.00	Euro 1/Turbo Intercooled	125/170							
	D 0826 LE 521	6871	6	108.00	Turbo Intercooled	140/190							
	D 0826 LE 530	6871	6	108.00	Euro 1/Turbo Intercooled	147/200							
	D 0826 LE 522	6871	6	108.00	Euro 1/Turbo Intercooled	154/209							
	D 0826 LE 523/ D 0826 LE 527	6871	6	108.00	Euro 1/Turbo Intercooled	169/230							
	19	D 0826 LFL10	6871	6	108.00	Euro 1/Turbo Intercooled				162/220	BV500 (SE) (x3)	DV500 ○ (x3)	EV501 GV502 ○
D 0826 LOH17		6871	6	108.00	Euro 2/Turbo Intercooled	162/220							
D 0836 LF02/D 0836 LF04		6871	6	108.00	Euro 3/Turbo Intercooled	162/220							
D 0836 LFL02		6871	6	108.00	Euro 2/3/Turbo Intercooled	162/220							
D 0836 LFL04/ D 0836 LOH03/D 0836 LUH02		6871	6	108.00	Euro 3/Turbo Intercooled	162/220							
D 0826 LFL02		6871	6	108.00	Euro 1/Turbo Intercooled	169/230							
D 0836 LF05/D 0836 LFL05		6871	6	108.00	Euro 3/Turbo Intercooled	180/245							
D 0826 LOH10		6871	6	108.00	Euro 1/Turbo Intercooled	184/250							
D 0836 LF01		6871	6	108.00	Euro 2/Turbo Intercooled	206/280							
D 0836 LF03		6871	6	108.00	Euro 3/Turbo Intercooled	206/280							
D 0836 LFL01		6871	6	108.00	Euro 2/3/Turbo Intercooled	206/280							
D 0836 LFL03/ D 0836 LOH01/ D 0836 LOH02/ D 0836 LUH01		6871	6	108.00	Euro 3/Turbo Intercooled	206/280							
20		D 0826 GF02	6871	6	108.00		169/230	BV500 (SE) (x3)	DV500 ○ (x3)	EV500 GV501 ○			
21		D 0826 LOH03/D 0826 LOH04	6871	6	108.00	Turbo Intercooled	169/230	BV500 (SE) (x3)	DV500 ○ (x3)	EV501 GV502 ○			

						 BV500 JM354
JD118 (x6) JD124 (x6)	JM354 (x3)	JJ490	HR775	<input checked="" type="checkbox"/> NA5156 66x90x12mm, PTFE <input checked="" type="checkbox"/> NB967 66x90x12mm, FPM <input checked="" type="checkbox"/> NA5181 110x130x13mm, PTFE <input checked="" type="checkbox"/> NF754 110x130x12mm, FPM	HBS473 [8] M14x2x140,0mm (x8)	
JD118 (x6) JD124 (x6)	JM354 (x3)	HR397 [20]		<input checked="" type="checkbox"/> NA5156 66x90x12mm, PTFE <input checked="" type="checkbox"/> NB967 66x90x12mm, FPM <input checked="" type="checkbox"/> NA5181 110x130x13mm, PTFE <input checked="" type="checkbox"/> NF754 110x130x12mm, FPM	HBS473 [8] M14x2x140,0mm (x8)	
JD118 (x6) JD124 (x6)	JM354 (x3)	JJ490	HR775	<input checked="" type="checkbox"/> NA5156 66x90x12mm, PTFE <input checked="" type="checkbox"/> NB967 66x90x12mm, FPM <input checked="" type="checkbox"/> NA5181 110x130x13mm, PTFE <input checked="" type="checkbox"/> NF754 110x130x12mm, FPM	HBS473 [8] M14x2x140,0mm (x8)	
JD118 (x6) JD124 (x6)		JJ490	HR775	<input checked="" type="checkbox"/> NA5156 66x90x12mm, PTFE <input checked="" type="checkbox"/> NB967 66x90x12mm, FPM <input checked="" type="checkbox"/> NA5181 110x130x13mm, PTFE <input checked="" type="checkbox"/> NF754 110x130x12mm, FPM	HBS473 [8] M14x2x140,0mm (x8)	
JD118 (x6) JD124 (x6)		JJ490		<input checked="" type="checkbox"/> NB967 66x90x12mm, FPM <input checked="" type="checkbox"/> NF754 110x130x12mm, FPM <input checked="" type="checkbox"/> NA5156 66x90x12mm, PTFE <input checked="" type="checkbox"/> NA5181 110x130x13mm, PTFE	HBS473 [8] M14x2x140,0mm (x8)	









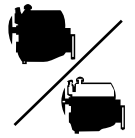



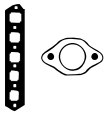



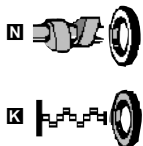
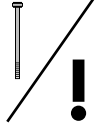
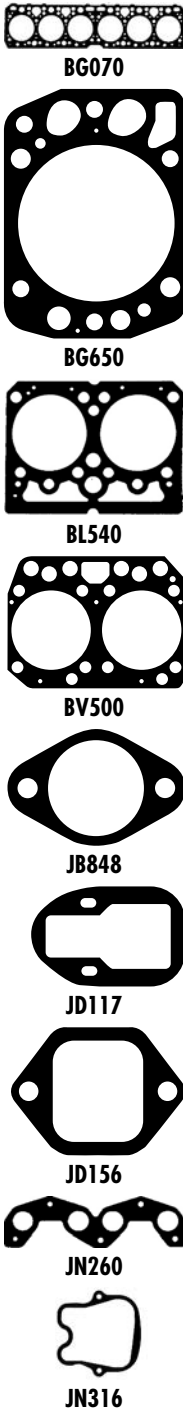















cc



kW/PS



22	D 0836 LFL40	6871	6	108.00	Euro 3/Turbo Intercooled	176/240	BV500 (SE) (x3)		
	D 0836 LFL50/D 0836 LFL53	6871	6	108.00	Euro 4/Turbo Intercooled	176/240			
	D 0836 LFL52	6871	6	108.00	Euro 4/Turbo Intercooled	177/240			
	D 0836 LOH41	6871	6	108.00	Euro 3/Turbo Intercooled	177/240			
	D 0836 LOH52/D 0836 LOH56	6871	6	108.00	Euro 4/Turbo Intercooled	177/240			
	D 0836 LUH41	6871	6	108.00	Euro 3/Turbo Intercooled	177/240			
	D 0836 LOH 63	6871	6	108.00	EEV/Turbo Intercooled/Straight	191/260			
	D 0836 LOH62	6871	6	108.00	Euro 4/Turbo Intercooled	191/260			
	D 0836 LF41/D 0836 LFL41	6871	6	108.00	Euro 3/Turbo Intercooled	206/280			
	D 0836 LFL51/D 0836 LFL54	6871	6	108.00	Euro 4/Turbo Intercooled	206/280			
	D 0836 LOH40	6871	6	108.00	Euro 3/Turbo Intercooled	206/280			
	D 0836 LOH51/D 0836 LOH55	6871	6	108.00	Euro 4/Turbo Intercooled	206/280			
	D 0836 LUH40	6871	6	108.00	Euro 3/Turbo Intercooled	206/280			
	D 0836 LF44/D 0836 LFL44	6871	6	108.00	Euro 3/Turbo Intercooled	240/326			
	D 0836 LFL55	6871	6	108.00	Euro 4/Turbo Intercooled	240/326			
	23	D 0836 HM3U/D 0836 HM5U	7030	6	108.00				
D 0836 HM8U		7030	6	108.00		117/159			
24	D 0836 HM4	7030	6	108.00		110-115/ 150-156	BL540 (Fibre) (x3)		
	D 0836 HM70	7030	6	108.00		110-114/ 150-156			
	D 0836 HM71/D 0836 HMN70	7030	6	108.00		114/155			
	D 0836 HM7	7030	6	108.00		114-117/ 156-160			
	D 0836 HM7U/D 0836 HM9H/ D 0836 HM9U	7030	6	108.00		117/159			
25	D 0846 HM2	7250	6	108.00		117/159	BL540 (Fibre) (x3)		
26	D 0846 HMN	7252	6	108.00		117/159	BL540 (Fibre) (x3)		
27	D 2555 M/D 2555 MF	9200	5	125.00		123/167	BG650 (Fibre) (x5)	DG650 ■○ (x5) DG651 (x5)	
	D 2555 MX/D 2555 MXF/ D 2555 MXUL	9200	5	125.00		141/192			
28	D 2565 ME	9510	5	125.00		84/114	BG650 (Fibre) (x5)	DG650 ■○ (x5) DG651 (x5)	
	D 2565 HM/D 2565 MFR/ D 2565 MUH	9510	5	125.00		92/125			
	D 2565 M/168	9510	5	125.00		123/167			
	D 2565 MF/168	9510	5	125.00		123/168			
	D 2565 MSFV	9510	5	125.00		136/185			
	D 2565 M/D 2565 MF/ D 2565 MH/D 2565 MR/ D 2565 MUE/D 2565 MUL	9510	5	125.00		141/192			
	D 2565 MK/D 2565 MKUL/ D 2565 MT	9510	5	125.00	Turbo	169/230			
29	D 2146 M1	9660	6	121.00		126/171	BG070 (Fibre)	DG071 ■○	
	D 2146 HM/D 2146 M11	9660	6	121.00		132/180			
	D 2146 M14/D 2146 M9/ D 2146 MN/D 2146 MN11	9660	6	121.00		136/185			
	D 2146 HMTU	9660	6	121.00		141/192			
	D 2146 MT1/D 2146 MT1F	9660	6	121.00		154/210			
	D 2146 HM1	9660	6	121.00		155/211			
	D 2146 HMN	9660	6	121.00		158/215			

						
				<p> <input checked="" type="checkbox"/> NA5156  66x90x12mm, PTFE <input checked="" type="checkbox"/> NB967  66x90x12mm, FPM <input checked="" type="checkbox"/> NA5181  110x130x13mm, PTFE <input checked="" type="checkbox"/> NF754  110x130x12mm, FPM </p>	<p> HBS472 [8]   M14x2x152mm (x8) </p>	
JB848  (x6)						
JB848  (x6)	JN260 (x3)		HR775 			
JB848  (x6)	JN260 (x3)		HR775 			
JD117  (x5) JD156  (x5)	JN316 (x5)			<p> <input checked="" type="checkbox"/> NB928  105x130x12mm, FPM <input checked="" type="checkbox"/> NB929  120x140x13mm, FPM </p>	<p> HBS226 [8]   M15x2.0x168mm (x2) M15x2.0x144mm (x3) M15x2.0x109mm (x1) HL5070 (x5) [14]  </p>	
JD117  (x5) JD156  (x5)	JN316 (x5)			<p> <input checked="" type="checkbox"/> NB928  105x130x12mm, FPM <input checked="" type="checkbox"/> NB929  120x140x13mm, FPM </p>	<p> HBS226 [8]   M15x2.0x168mm (x2) M15x2.0x144mm (x3) M15x2.0x109mm (x1) HL5070 (x5) [14]  </p>	
JB848  (x6)						









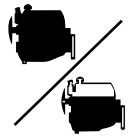



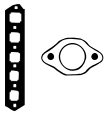

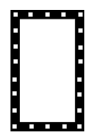
cc

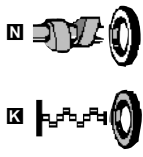
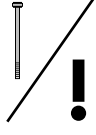

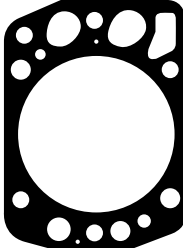
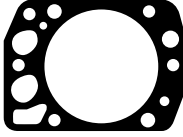
kW/PS



30	D 2865 LF/260	9973	5	128.00	Turbo Intercooled	191/260	AH5450 (Fibre) (x5)[21] BG850 (SE) (x5)	DG855 ○ (x5)	GG85A
	D 2865 LUH09	9973	5	128.00	Euro 2/Turbo Intercooled	191/260			
	D 2865 LOH01/ D 2865 LUH02/D 2865 LUH05	9973	5	128.00	Euro 1/Turbo Intercooled	198/270			
	D 2865 LUH07	9973	5	128.00	Euro 2/Turbo Intercooled	228/310			
	D 2865 LOH02/D 2865 LUH08	9973	5	128.00	Euro 1/Turbo Intercooled	235/320			
31	D 2865 LF02	9973	5	128.00	Turbo Intercooled	198/270	AH5450 (Fibre) (x5)[21] BG850 (SE) (x5)	DG855 ○ (x5)	GG85A
32	D 2865 LF05/D 2865 LF22/ D 2865 LU01/Silent/ D 2865 LU05	9973	5	128.00	Euro 1/Turbo Intercooled	198/270	AH5450 (Fibre) (x5)[21] BG850 (SE) (x5)	DG855 ○ (x5)	EG856
	D 2865 LF20	9973	5	128.00	Turbo Intercooled	213/290			
	D 2865 LF24	9973	5	128.00	Euro 2/Turbo Intercooled	213/290			
	D 2865 LF03	9973	5	128.00	Turbo Intercooled	235/320			
	D 2865 LF06/D 2865 LF23	9973	5	128.00	Euro 1/Turbo Intercooled	235/320			
	D 2865 LF09	9973	5	128.00	Turbo Intercooled	250/340			
	D 2865 LF21	9973	5	128.00	Euro 2/Turbo Intercooled	250/340			
	33	D 2156 HM 2	10344	6	121.00				
D 2156 HM1U/ D 2156 HM51U/ D 2156 HM52U/ D 2156 HM5U/D 2156 HMN-5/ D 2156 HMXU-037/D 2156 HMXU-038		10344	6	121.00		141/192			
D 2156 HNY/D 2156 MGN/ D 2156 MNY/D 2156 MY		10344	6	121.00		141-169/ 192-230			
D 2156 MY30		10344	6	121.00		141/192			
D 2156 MYN		10344	6	121.00		141-169/ 192-230			
D 2156 MYN-31		10344	6	121.00		141/192			
D 2156 HM6H		10344	6	121.00		155/211			
D 2156 HM3/D 2156 HM9		10344	6	121.00		158-169/ 215-230			
D 2156 HMN1/ D 2156 HMX-032		10344	6	121.00		158/215			
D 2156 HMN6		10344	6	121.00		172/234			
D 2156 HM6HDK		10344	6	121.00		173/235			
D 2156 MTN1		10344	6	121.00	Turbo Intercooled	188/256			
D 2156 MTX/ D 2156 MTX-034/D 2156 MTXN-035		10344	6	121.00	Turbo	188/256			
D 2156 MTN5		10344	6	121.00	Turbo	209/284			
34		D 2556 MXUH/175	11045	6	125.00		129/175	BG650 (Fibre) (x6)	DG650 ■○ (x6)
	D 2556 MXUH/192	11045	6	125.00		141/192			
	D 2556 MXUM	11045	6	125.00		161/220			
	D 2556 MXUH/240	11045	6	125.00		177/240			
	D 2556 MTE	11045	6	125.00	Turbo Intercooled	191/260			
35	D 2556 M/D 2556 MF	11045	6	125.00		147/200	BG650 (Fibre) (x6)	DG650 ■○ (x6)	GG651
	D 2556 MX	11045	6	125.00		147-194/ 200-264			
	D 2556 MXF	11045	6	125.00		172-177/ 232-240			

     						 BG070  BG650  BG850  JB848  JD117  JD156  JN316  JJ495	
JD117 ■ (x5) JD156 ■ (x5)	JN316 (x5)			<input checked="" type="checkbox"/> NB928 ■ 105x130x12mm, FPM <input checked="" type="checkbox"/> NB929 ■ 120x140x13mm, FPM <input checked="" type="checkbox"/> NB966 ■ 115x140x16mm, FPM	HBS226 [8] ☉ M15x2.0x168mm (x2) M15x2.0x144mm (x3) M15x2.0x109mm (x1) HT019 (x5)[14] ■		
JD117 ■ (x5) JD156 ■ (x5)	JN316 (x5)			<input checked="" type="checkbox"/> NB928 ■ 105x130x12mm, FPM <input checked="" type="checkbox"/> NB929 ■ 120x140x13mm, FPM	HBS226 [8] ☉ M15x2.0x168mm (x2) M15x2.0x144mm (x3) M15x2.0x109mm (x1) HT019 (x5)[14] ■		
JD117 ■ (x10) JD156 ■ (x10)	JN316 (x10)			<input checked="" type="checkbox"/> NB928 ■ 105x130x12mm, FPM <input checked="" type="checkbox"/> NB929 ■ 120x140x13mm, FPM	HBS226 [8] ☉ M15x2.0x168mm (x2) M15x2.0x144mm (x3) M15x2.0x109mm (x1) HT019 (x10)[14] ■		
JB848 ■ (x6)							
JD117 ■ (x6) JD156 ■ (x6)	JN316 (x6)	JJ495		<input checked="" type="checkbox"/> NB928 ■ 105x130x12mm, FPM <input checked="" type="checkbox"/> NB929 ■ 120x140x13mm, FPM	HL5070 (x6)[14] ■		
JD117 ■ (x6) JD156 ■ (x6)	JN316 (x6)	JJ495		<input checked="" type="checkbox"/> NB928 ■ 105x130x12mm, FPM <input checked="" type="checkbox"/> NB929 ■ 120x140x13mm, FPM	HL5070 (x6)[14] ■		



cc







Ø

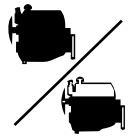

kW/PS

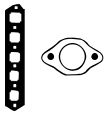

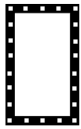
36	D 2566 ME/D 2566 MUE	11413	6	125.00		125/170	BG650 (Fibre) (x6)	DG650 ■○ (x6)
	D 2566 MXF	11413	6	125.00		125/211		
	D 2566 MUH/175	11413	6	125.00		128/174		
	D 2566 MUH/192	11413	6	125.00		141/192		
	D 2566 MUH/200	11413	6	125.00		147/200		
	D 2566 MUM	11413	6	125.00		147-177/ 200-241		
	D 2566 MUM/200	11413	6	125.00		147/200		
	D 2566 UH/205	11413	6	125.00		147-150/ 200-205		
	D 2566 UH	11413	6	125.00		155/211		
	D 2566 MSFV	11413	6	125.00		161/220		
	D 2566 MF/220	11413	6	125.00		162/220		
	D 2566 MTE	11413	6	125.00	Turbo	162/220		
	D 2566 MUH/220/	11413	6	125.00		162/220		
	D 2566 MUM/220							
	D 2566 MUH	11413	6	125.00	Turbo	177/240		
	D 2566 MUH/240/	11413	6	125.00		177/240		
	D 2566 MUL/D 2566 MUM/240							
	D 2566 MLUH	11413	6	125.00	Turbo Intercooled	192/260		
	D 2566 MK/280/	11413	6	125.00	Turbo Intercooled	206/280		
	D 2566 MKF/280							
	D 2566 MT/D 2566 MTF/	11413	6	125.00	Turbo	206/280		
	D 2566 MTFG							
	D 2566 MTHO	11413	6	125.00	Turbo	206-235/ 280-320		
	D 2566 MTSF/D 2566 MTUH/	11413	6	125.00	Turbo	206/280		
	280							
	D 2566 MTH	11413	6	125.00	Turbo	213/290		
	D 2566 MLUM/US	11413	6	125.00	Turbo Intercooled	222/305		
	D 2566 MLUM	11413	6	125.00	Turbo Intercooled	227/310		
	D 2566/D 2566 MK	11413	6	125.00	Turbo	235/320		
	D 2566 MKF/D 2566 MKUH/	11413	6	125.00	Turbo Intercooled	235/320		
	320/D 2566 MKUL							
	37	D 2566 M/D 2566 MF/	11413	6	125.00			
D 2566 MH/D 2566 MHO							GG651	

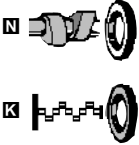
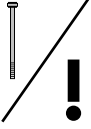
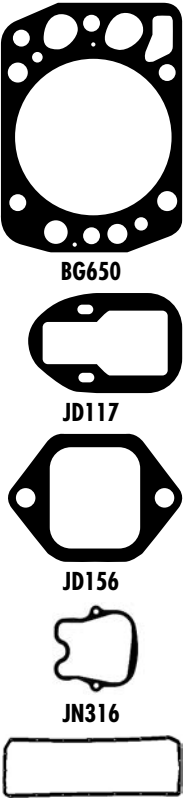
						
JD117 ■ (x6) JD156 ■ (x6)	JN316 (x6)	JJ495		■ NB928 ■ 105x130x12mm, FPM ■ NB929 ■ 120x140x13mm, FPM	HL5070 (x6) [14] ■	
JD117 ■ (x6) JD156 ■ (x6)	JN316 (x6)	JJ495		■ NB928 ■ 105x130x12mm, FPM ■ NB929 ■ 120x140x13mm, FPM	HL5070 (x6) [14] ■	









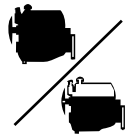

cc

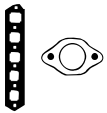

kW/PS

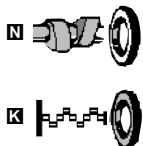
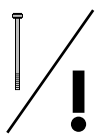
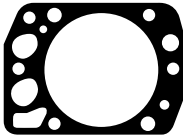

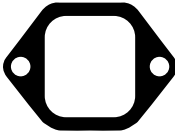
38	D 2866 UM	11967	6	128.00		152-177/ 206-241	AH5450 (Fibre) (x6)[21] BG850 (SE) (x6)	DG855 ○ (x6)	EH5451
	D 2866 F/240	11967	6	128.00		177/240			
	D 2866 UH/240	11967	6	128.00	Turbo	177/240			
	D 2866 FR	11967	6	128.00		177/241			
	D 2866 UH	11967	6	128.00		177-186/ 241-253			
	D 2866 LUH22	11967	6	128.00	Euro 2/Turbo	191/260			
	D 2866 LX	11967	6	128.00	Turbo Intercooled	198/269			
	D 2866 LXF	11967	6	128.00	Turbo Intercooled	198-274/ 269-372			
	D 2866 TUH/290	11967	6	128.00	Turbo	213-224/ 290-305			
	D 2866 TUH01	11967	6	128.00	Turbo	222/302			
	D 2866 TUH	11967	6	128.00	Turbo	224-229/ 305-311			
	D 2866 LOH25/D 2866 LUH20	11967	6	128.00	Euro 2/Turbo Intercooled	228/310			
	D 2866 LUH26	11967	6	128.00	Euro 2/Turbo	228/310			
	D 2866 LUH26	11967	6	128.00	Euro 2/Turbo Intercooled	228/310			
	D 2866 TOH	11967	6	128.00	Turbo	229/311			
	D 2866 LFZ/330	11967	6	128.00	Turbo Intercooled	243/330			
	D 2866 LOH	11967	6	128.00	Turbo Intercooled	243-309/ 330-420			
	D 2866 LU/330/D 2866 LUH/330	11967	6	128.00	Turbo Intercooled	243/330			
	D 2866 LOH26	11967	6	128.00	Euro 2/Turbo Intercooled	257/350			
	D 2866 LUH21	11967	6	128.00	Euro 2/Turbo	257/350			
	D 2866 LXOH	11967	6	128.00	Turbo Intercooled	265-274/ 360-373			
	D 2866 LOH07	11967	6	128.00	Turbo Intercooled	272/370			
	D 2866 LOH22	11967	6	128.00	Euro 1/Turbo Intercooled	272/370			
	D 2866 LF14	11967	6	128.00	Euro 2/Turbo Intercooled	294-309/ 400-420			
	D 2866 LOH23	11967	6	128.00	Euro 2/Turbo Intercooled	294/400			
	D 2866 LOH03	11967	6	128.00	Turbo Intercooled	309/420			
	D 2866 LOH06/D 2866 LOH20	11967	6	128.00	Euro 1/Turbo Intercooled	309/420			
39	E 2866	11967	6	128.00		170/230	AH5450 (Fibre) (x6)[21] BG850 (SE) (x6)	DG855 ○ (x6)	
	E 2866 DF01/E 2866 DUH01	11967	6	128.00		170/231			
	E 2866 DF02	11967	6	128.00	Euro 3	174/236			
	E 2866 DF03/E 2866 DF04	11967	6	128.00		174/236			
	E 2866 DOH02/	11967	6	128.00	Euro 3	178/242			
	E 2866 DOH03/E 2866 DOH04	11967	6	128.00					
	E 2866 DUH03	11967	6	128.00	Euro 3	180/245			
	D 2866 LUH25/D 2866 LUH29	11967	6	128.00	Euro 3/Turbo Intercooled	265/360			
40	D 2866 LUH23	11967	6	128.00	Euro 3/Turbo Intercooled	191/260	AH5450 (Fibre) (x6)[21] BG850 (SE) (x6)	DG855 ○ (x6)	
41	D 2866 LF/290/D 2866 LFZ/290	11967	6	128.00	Turbo Intercooled	213/290	AH5450 (Fibre) (x6)[21] BG850 (SE) (x6)	DG855 ○ (x6)	
	D 2866 LF/330	11967	6	128.00	Turbo Intercooled	243/330			
	D 2866 KOH/360	11967	6	128.00	Turbo Intercooled	265/360			
	D 2866 KUH/360	11967	6	128.00	Euro 1/Turbo Intercooled	265/360			
	D 2866 KUL	11967	6	128.00	Turbo Intercooled	265/360			

						
JD117 ■ (x6) JD156 ■ (x6)	JN316 (x6)	JJ495		☒ NB928 ■ 105x130x12mm, FPM ☒ NB929 ■ 120x140x13mm, FPM	HBS226 [8] ☉ M15x2.0x168mm (x2) M15x2.0x144mm (x3) M15x2.0x109mm (x1) HTO19 [14] ■	BG850  JD117  JD150  JD156  JN316  JJ495
JD117 ■ (x6) JD156 ■ (x6)	JN316 (x6)	JJ495				
JD117 ■ (x6) JD150 ■ (x6)	JN316 (x6)	JJ495		☒ NB928 ■ 105x130x12mm, FPM ☒ NB929 ■ 120x140x13mm, FPM	HBS366 [8] ☉ M15x2.0x259.5mm (x3) M15x2.0x198mm (x3) HTO19 [14] ■	
JD117 ■ (x6) JD156 ■ (x6)	JN316 (x6)	JJ495		☒ NB928 ■ 105x130x12mm, FPM ☒ NB929 ■ 120x140x13mm, FPM	HBS226 [8] ☉ M15x2.0x168mm (x2) M15x2.0x144mm (x3) M15x2.0x109mm (x1) HTO19 (x6) [14] ■	









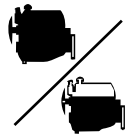

cc

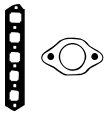

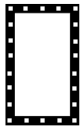
kW/PS

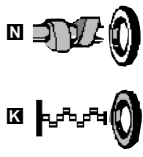
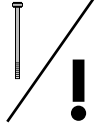
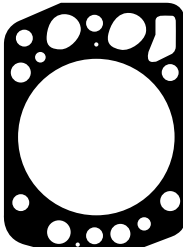
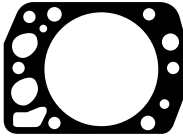

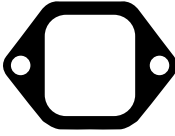
42	D 2866 T/D 2866 TOH/290	11967	6	128.00	Turbo	213/290	AH5450 (Fibre) (x6)[21] BG850 (SE) (x6)	DG855 ○ (x6)	
	D 2866 LF04	11967	6	128.00	Turbo Intercooled	220/300			
	D 2866 TOH/310	11967	6	128.00	Turbo	229/311			
	D 2866 LF03	11967	6	128.00	Turbo Intercooled	272/370			
	D 2866 LF05	11967	6	128.00	Euro 1/Turbo Intercooled	272/370			
	D 2866 KOH/373	11967	6	128.00	Turbo Intercooled	274/373			
	D 2866 LF16	11967	6	128.00	Euro 2/Turbo Intercooled	294/400			
	D 2866 LF06	11967	6	128.00	Turbo Intercooled	309/420			
D 2866 LF09/D 2866 LF10	11967	6	128.00	Euro 1/Turbo Intercooled	309/420				
43	D 2866 LF23/D 2866 LF26	11967	6	128.00	Euro 3/Turbo Intercooled	228/310	AH5450 (Fibre) (x6)[21] BG850 (SE) (x6)	DG855 ○ (x6)	
	D 2866 LF36	11967	6	128.00	Euro 2/Turbo Intercooled	228/310			
	D 2866 LOH27/ D 2866 LOH32/D 2866 LUH24	11967	6	128.00	Euro 3/Turbo Intercooled	228/310			
	D 2866 LF24	11967	6	128.00	Euro 3/Turbo Intercooled	265/360			
	D 2866 LF27	11967	6	128.00	Euro 4/Turbo Intercooled	265/360			
	D 2866 LF37	11967	6	128.00	Euro 2/Turbo Intercooled	265/360			
	D 2866 LOH28/D 2866 LOH33	11967	6	128.00	Euro 3/Turbo Intercooled	265/360			
	D 2866 LF29	11967	6	128.00	Euro 2/Turbo Intercooled	294/400			
	D 2866 LF30	11967	6	128.00	Euro 2/Turbo Intercooled	301/409			
	D 2866 LF31	11967	6	128.00	Euro 2/Turbo Intercooled	301/409			
	D 2866 LF25/D 2866 LF28	11967	6	128.00	Euro 3/Turbo Intercooled	301/410			
	D 2866 LF32	11967	6	128.00	Euro 2/Turbo Intercooled	301/410			
	D 2866 LOH29/ D 2866 LOH34/D 2866 LUH30	11967	6	128.00	Euro 3/Turbo Intercooled	301/410			
	44	D 2866 LF34	11967	6	128.00	Turbo Intercooled			
D 2866 LF35		11967	6	128.00	Turbo Intercooled	265/360			
D 2866 LF21		11967	6	128.00	Euro 1/Turbo Intercooled	272/370			
D 2866 LF20		11967	6	128.00	Euro 2/Turbo Intercooled	294/400			
D 2866 LF22		11967	6	128.00	Euro 1/Turbo Intercooled	309/420			
45	E 2866 LUH02	11967	6	128.00	Euro 3/Turbo Intercooled	228/310	AH5450 (Fibre) (x6)[21] BG850 (SE) (x6)	DG855 ○ (x6)	
46	D 2866 LUL/330	11967	6	128.00	Turbo Intercooled	243/330	AH5450 (Fibre) (x6)[21] BG850 (SE) (x6)	DG855 ○ (x6)	
	D 2866 KF/D 2866 KFZ	11967	6	128.00	Turbo Intercooled	265/360			
	D 2866 LF15	11967	6	128.00	Euro 1/Turbo Intercooled	272/370			
47	E 2866 DUH	11970	6	128.00		170/231	AH5450 (Fibre) (x6)[21] BG850 (SE) (x6)	DG855 ○ (x6)	
48	D 2866 LOH24	11970	6	128.00	Euro 1/Turbo Intercooled	230/310	AH5450 (Fibre) (x6)[21] BG850 (SE) (x6)	DG855 ○ (x6)	
49	D 2538 MT	12763	8	125.00	Turbo/V	178-235/ 242-320	BG650 (Fibre) (x8)	DG650 ■○ (x8)	
	D 2538 MTE	12763	8	125.00	Turbo/V	178/242			
	D 2538 M/D 2538 ME/ D 2538 MF	12763	8	125.00	V	188/256			

     						
JD117 ■ (x6) JD156 ■ (x6)	JN316 (x6)	JJ495		<input checked="" type="checkbox"/> NB928 ■ 105x130x12mm, FPM <input checked="" type="checkbox"/> NB929 ■ 120x140x13mm, FPM	HBS226 [8] ☉ M15x2.0x168mm (x2) M15x2.0x144mm (x3) M15x2.0x109mm (x1)	 BG650  BG850  JD117  JD156  JN316  JJ495
JD117 ■ (x6) JD156 ■ (x6)	JN316 (x6)	JJ495		<input checked="" type="checkbox"/> NB928 ■ 105x130x12mm, FPM <input checked="" type="checkbox"/> NB929 ■ 120x140x13mm, FPM	HBS366 [8] ☉ M15x2.0x259.5mm (x3) M15x2.0x198mm (x3) HTO19 [14] ■	
JD117 ■ (x6) JD156 ■ (x6)	JN316 (x6)	JJ495		<input checked="" type="checkbox"/> NB928 ■ 105x130x12mm, FPM <input checked="" type="checkbox"/> NB929 ■ 120x140x13mm, FPM	HBS226 [8] ☉ M15x2.0x168mm (x2) M15x2.0x144mm (x3) M15x2.0x109mm (x1) HTO19 [14] ■	
JD117 ■ (x6) JD156 ■ (x6)	JN316 (x6)	JJ495			HBS226 [8] ☉ M15x2.0x168mm (x2) M15x2.0x144mm (x3) M15x2.0x109mm (x1) HTO19 [14] ■	
JD117 ■ (x6) JD156 ■ (x6)	JN316 (x6)	JJ495		<input checked="" type="checkbox"/> NB928 ■ 105x130x12mm, FPM <input checked="" type="checkbox"/> NB929 ■ 120x140x13mm, FPM	HBS226 [8] ☉ M15x2.0x168mm (x2) M15x2.0x144mm (x3) M15x2.0x109mm (x1) HTO19 (x6) [14] ■	
JD117 ■ (x6) JD156 ■ (x6)	JN316 (x6)	JJ495		<input checked="" type="checkbox"/> NB928 ■ 105x130x12mm, FPM <input checked="" type="checkbox"/> NB929 ■ 120x140x13mm, FPM	HBS226 [8] ☉ M15x2.0x168mm (x2) M15x2.0x144mm (x3) M15x2.0x109mm (x1) HTO19 [14] ■	
JD117 ■ (x8) JD156 ■ (x8)	JN316 (x8)		PB224 (x16) 12x16/20x15 860N (FPM)	<input checked="" type="checkbox"/> NB928 ■ 105x130x12mm, FPM <input checked="" type="checkbox"/> NB929 ■ 120x140x13mm, FPM	HBS226 [8] ☉ M15x2.0x168mm (x2) M15x2.0x144mm (x3) M15x2.0x109mm (x1) HTO19 (x6) [14] ■	









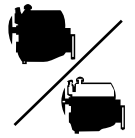



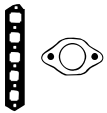

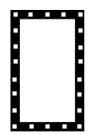

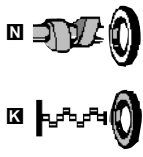
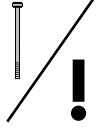







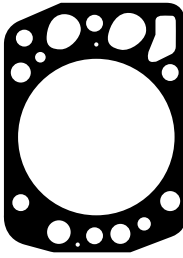
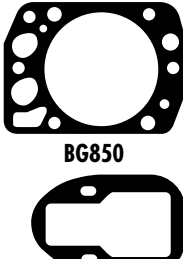
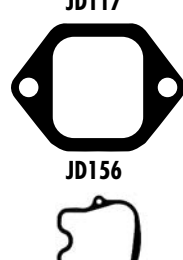
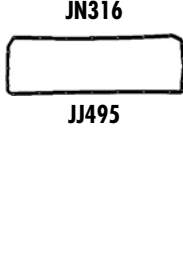































































cc



kW/PS



50	D 2876 LF02	12816	6	128.00	Euro 2/Turbo Intercooled	338/460	AH5450 (Fibre) (x6)[21] BG850 (SE) (x6)	DG855 ○ (x6)	EH5450
51	D 2876 LF03/D 2876 LF04	12816	6	128.00	Euro 3/Turbo Intercooled	338/460	AH5450 (Fibre) (x6)[21] BG850 (SE) (x6)		
	D 2876 LF06	12816	6	128.00	Turbo Intercooled	338/460			
	D 2876 LF07/D 2876 LF11/ D 2876 LOH01	12816	6	128.00	Euro 2/Turbo Intercooled	338/460			
	D 2876 LOH02/D 2876 LOH03	12816	6	128.00	Euro 3/Turbo Intercooled	338/460			
	D 2876 LF05	12816	6	128.00	Euro 3/Turbo Intercooled	375/510			
52	D 2876 LF12/D 2876 LF25/ D 2876 LOH20	12816	6	128.00	Euro 3/Turbo Intercooled	353/480			
	D 2876 LF13/D 2876 LOH21	12816	6	128.00	Euro 3/Turbo Intercooled	390/530			
53	D 2848 M/D 2848 MH	14618	8	128.00	V	206/280	AH5450 (Fibre) (x8)[21] BG850 (SE) (x8)	DG855 ○	
	D 2848 LXE/D 2848 LYE	14618	8	128.00	Turbo Intercooled/V	500/680			
54	D 2530 MTXF/360	15900	10	125.00	Turbo/V	265/360	AH5450 (Fibre) (x10)[21] BG850 (SE) (x10)	DG855 ○	
55	D 2530 ME	15945	10	125.00	V	156/212	AH5450 (Fibre) (x10)[21] BG850 (SE) (x10)	DG855 ○	
	D 2530 MXF	15945	10	125.00	V	156-235/ 212-320			
56	D 2530 MF	15945	10	125.00	V	235/320	BG650 (Fibre) (x10)	DG650 ■○ (x10)	
57	D 2530 MXFR/D 2530 MXH	15953	10	125.00	/V		BG650 (Fibre) (x10)	DG650 ■○ (x10)	
58	D 2530 MTE	15953	10	125.00	Turbo/V	223/303	BG650 (Fibre) (x10)	DG650 ■○ (x10)	
	D 2530 MTXF	15953	10	125.00	Turbo/V	294/400			
59	D 2540 MT/D 2540 MTF/390	17426	10	125.00	Turbo/V	287/390	AH5450 (Fibre) (x10)[21] BG650 (Fibre) (x10) →Eng.4607064 BG850 (SE) (x10) Eng.4607064→	DG650 ■○ →Eng.4607064 DG855 ○ (x10) Eng.4607064→	
	D 2540 MTF	17426	10	125.00	Turbo/V	324/440			
60	D 2840 ME/D 2840 MH	18273	10	128.00	V	244/332	AH5450 (Fibre) [21] BG850 (SE) (x10)	DG855 ○ (x10)	
	D 2840 MFR	18273	10	128.00	V	268-245/ 364-333			
	D 2840 MF/D 2840 MFG	18273	10	128.00	V	268/365			
	D 2840 LF/460/D 2840 LXF	18273	10	128.00	Turbo Intercooled/V	338/460			
	D 2840 LE	18273	10	128.00	Turbo Intercooled/V	346/471			
	D 2840 LF01	18273	10	128.00	Turbo Intercooled/V	368/500			
	D 2840 LF04/D 2840 LF06	18273	10	128.00	Euro 1/Turbo Intercooled/V	368/500			
	D 2840 LF20/D 2840 LF21	18273	10	128.00	Euro 2/Turbo Intercooled/V	441/600			
	D 2840 LF25	18273	10	128.00	Euro 3/Turbo Intercooled/V	485-515/ 660-700			
	D 2840 LXE/D 2840 LYE	18273	10	128.00	Turbo Intercooled/V	603/820			
61	D 2840 TL	18273	10	128.00	Turbo Intercooled/V	603/820	AH5450 (Fibre) (x10)[21] BG850 (SE) (x10)	DG855 ○ (x10)	

     						
JD117  (x6) JD156  (x6)	JN316 (x6)	JJ495		<input checked="" type="checkbox"/> NB928  105x130x12mm, FPM <input checked="" type="checkbox"/> NB929  120x140x13mm, FPM	HBS226 [8]   M15x2.0x168mm (x2) M15x2.0x144mm (x3) M15x2.0x109mm (x1) HT019 [14] 	 BG650  BG850  JD117  JD156  JN316  JJ495
JD117  (x6) JD156  (x6)	JN316 (x6)	JJ495		<input checked="" type="checkbox"/> NB928  105x130x12mm, FPM <input checked="" type="checkbox"/> NB929  120x140x13mm, FPM	HBS366 [8]   M15x2.0x259.5mm (x3) M15x2.0x198mm (x3) HT019 [14] 	
JD117  (x6) JD156  (x6)	JN316 (x6)	JJ495		<input checked="" type="checkbox"/> NB928  105x130x12mm, FPM <input checked="" type="checkbox"/> NB929  120x140x13mm, FPM	HBS367 [8]   M16x2.0x287.3mm (x3) M16x2.0x225.8mm (x3)	
JD117  (x8) JD156  (x8)	JN316 (x8)			<input checked="" type="checkbox"/> NB928  105x130x12mm, FPM <input checked="" type="checkbox"/> NB929  120x140x13mm, FPM	HBS226 [8]   M15x2.0x168mm (x2) M15x2.0x144mm (x3) M15x2.0x109mm (x1) HT019 [14] 	
JD117  (x10) JD156  (x10)	JN316 (x10)		PB224 (x20) 12x16/20x15 860N (FPM)	<input checked="" type="checkbox"/> NB928  105x130x12mm, FPM <input checked="" type="checkbox"/> NB929  120x140x13mm, FPM	HL5070 (x10)[14] 	
JD117  (x10) JD156  (x10)	JN316 (x10)		PB224 (x20) 12x16/20x15 860N (FPM)	<input checked="" type="checkbox"/> NB928  105x130x12mm, FPM <input checked="" type="checkbox"/> NB929  120x140x13mm, FPM	HL5070 (x10)[14] 	
JD117  (x10) JD156  (x10)	JN316 (x10)		PB224 (x20) 12x16/20x15 860N (FPM)	<input checked="" type="checkbox"/> NB928  105x130x12mm, FPM <input checked="" type="checkbox"/> NB929  120x140x13mm, FPM	HL5070 (x10)[14]   HT019 [14] 	
JD117  (x10) JD156  (x10)	JN316 (x10)			<input checked="" type="checkbox"/> NB928  105x130x12mm, FPM <input checked="" type="checkbox"/> NB929  120x140x13mm, FPM		
JD117  (x10) JD156  (x10)	JN316 (x10)		PB224 (x20) 12x16/20x15 860N (FPM)	<input checked="" type="checkbox"/> NB928  105x130x12mm, FPM <input checked="" type="checkbox"/> NB929  120x140x13mm, FPM	HL5070 (x10)[14]   HT019 [14] 	
JD117  (x10) Eng.4607064 → JD156  (x10) Eng.4607064 →	JN316 (x10) Eng.4607064 →			<input checked="" type="checkbox"/> NB929  120x140x13mm, FPM <input checked="" type="checkbox"/> NB928  105x130x12mm, FPM Eng.4607064 →	HBS226 [8]   M15x2.0x168mm (x2) M15x2.0x144mm (x3) M15x2.0x109mm (x1) Eng.4682001 → HL5070 (x10)[14]   HT019 (x10)[14] 	
JD117  (x10) JD156  (x10)	JN316 (x10)			<input checked="" type="checkbox"/> NB928  105x130x12mm, FPM <input checked="" type="checkbox"/> NB929  120x140x13mm, FPM	HBS226 [8]   M15x2.0x168mm (x2) M15x2.0x144mm (x3) M15x2.0x109mm (x1) HT019 [14] 	
JD117  (x10) JD156  (x10)	JN316 (x10)			<input checked="" type="checkbox"/> NB928  105x130x12mm, FPM <input checked="" type="checkbox"/> NB929  120x140x13mm, FPM	HBS226 [8]   M15x2.0x168mm (x2) M15x2.0x144mm (x3) M15x2.0x109mm (x1) HT019 [14] 	



cc





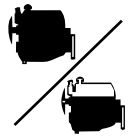













kW/PS



















62	D 2542 ME	20911	12	125.00	V		BG650 (Fibre) (x12)	DG650 ■○ (x12)	
63	D 2542 MTE	20911	12	125.00	Turbo/V	283/385	BG650 (Fibre) (x12)	DG650 ■○ (x12)	
	D 2542 MLE	20911	12	125.00	Turbo Intercooled/V	420/571			
64	D 2842 LE622	21927	12	128.00	Turbo Intercooled/V		AH5450 (Fibre) (x12)[21] BG850 (SE) (x12)	DG855 ○ (x12)	
65	D 2842 LF10	21927	12	128.00	Euro 3/Turbo Intercooled/V		AH5450 (Fibre) (x12)[21] BG850 (SE) (x12)	DG855 ○ (x12)	
	D 2842 ME	21927	12	128.00	V	275/374			
	D 2842 LXE	21927	12	128.00	Turbo Intercooled/V	662/900			
	D 2842 LYE/D 2842 LZE	21927	12	128.00	Turbo Intercooled/V	735/100			









JD117 (x12) JD156 (x12)	JN316 (x12)	JJ489	PB224 (x24) 12x16/20x15 860N (FPM)	<input checked="" type="checkbox"/> NB928 105x130x12mm, FPM <input checked="" type="checkbox"/> NB929 120x140x13mm, FPM		JD156	
JD117 (x12) JD156 (x12)	JN316 (x12)	JJ489	PB224 (x24) 12x16/20x15 860N (FPM)	<input checked="" type="checkbox"/> NB928 105x130x12mm, FPM <input checked="" type="checkbox"/> NB929 120x140x13mm, FPM		BG650	JN316
JD117 (x12) JD156 (x12)	JN316 (x12)	JJ489	PB224 (x24) 12x16/20x15 860N (FPM)	<input checked="" type="checkbox"/> NB928 105x130x12mm, FPM <input checked="" type="checkbox"/> NB929 120x140x13mm, FPM	HBS226 [8] ☉ M15x2.0x168mm (x2) M15x2.0x144mm (x3) M15x2.0x109mm (x1)		JJ489
JD117 (x12) JD156 (x12)	JN316 (x12)	JJ489	PB224 (x24) 12x16/20x15 860N (FPM)	<input checked="" type="checkbox"/> NB928 105x130x12mm, FPM <input checked="" type="checkbox"/> NB929 120x140x13mm, FPM	HBS226 [8] ☉ M15x2.0x168mm (x2) M15x2.0x144mm (x3) M15x2.0x109mm (x1) HT019 [14]		JD117









		cc			9			cc			9
M 476.920	CNG	11967	6	128.00	70	OM 327.933	Diesel	7980	6	115.00	42
M 476.921	CNG	11967	6	128.00	70	OM 327.934	Diesel	7980	6	115.00	42
M 476.925	CNG	11967	6	128.00	70	OM 327.935	Diesel	7980	6	115.00	42
M 476.926	CNG	11967	6	128.00	70	OM 327.936	Diesel	7980	6	115.00	42
M 476.927	LPG	11967	6	128.00	70	OM 327.937	Diesel	7980	6	115.00	42
M 476.930	CNG	11967	6	128.00	70	OM 327.938	Diesel	7980	6	115.00	42
M 476.932	CNG	11967	6	128.00	70	OM 327.939	Diesel	7980	6	115.00	42
M 476.933	CNG	11967	6	128.00	70	OM 327.940	Diesel	7980	6	115.00	42
M 476.934	CNG	11967	6	128.00	70	OM 327.941	Diesel	7980	6	115.00	42
M 476.935	Petrol	11967	6	128.00	70	OM 327.942	Diesel	7980	6	115.00	42
M 906.900	CNG	6374	6	102.00	40	OM 327.943	Diesel	7980	6	115.00	42
M 906.901	CNG	6374	6	102.00	40	OM 327.944	Diesel	7980	6	115.00	42
M 906.903	CNG	6374	6	102.00	40	OM 327.945	Diesel	7980	6	115.00	42
OM 312.954	Diesel	4580	6	90.00	24	OM 327.946	Diesel	7980	6	115.00	42
OM 314.900	Diesel	3782	4	97.00	18	OM 344.913	Diesel	5673	6	97.00	28
OM 314.910	Diesel	3782	4	97.00	18	OM 344.934	Diesel	5673	6	97.00	28
OM 314.914	Diesel	3782	4	97.00	18	OM 344.937	Diesel	5673	6	97.00	28
OM 314.915	Diesel	3782	4	97.00	18	OM 344.938	Diesel	5673	6	97.00	28
OM 314.916	Diesel	3782	4	97.00	18	OM 344.939	Diesel	5673	6	97.00	28
OM 314.917	Diesel	3782	4	97.00	18	OM 344.940	Diesel	5673	6	97.00	28
OM 314.918	Diesel	3782	4	97.00	18	OM 344.948	Diesel	5673	6	97.00	28
OM 314.919	Diesel	3782	4	97.00	18	OM 344.949	Diesel	5673	6	97.00	28
OM 314.940	Diesel	3782	4	97.00	18	OM 344.951	Diesel	5673	6	97.00	28
OM 314.941	Diesel	3782	4	97.00	18	OM 344.952	Diesel	5673	6	97.00	28
OM 314.942	Diesel	3782	4	97.00	18	OM 346.910	Diesel	10809	6	128.00	51
OM 314.943	Diesel	3782	4	97.00	18	OM 346.911	Diesel	10809	6	128.00	51
OM 314.944	Diesel	3782	4	97.00	18	OM 346.912	Diesel	10809	6	128.00	51
OM 314.945	Diesel	3782	4	97.00	18	OM 346.913	Diesel	10809	6	128.00	51
OM 314.946	Diesel	3782	4	97.00	18	OM 346.914	Diesel	10809	6	128.00	51
OM 314.947	Diesel	3782	4	97.00	18	OM 346.915	Diesel	10809	6	128.00	51
OM 314.948	Diesel	3782	4	97.00	18	OM 346.916	Diesel	10809	6	128.00	51
OM 314.949	Diesel	3782	4	97.00	18	OM 346.917	Diesel	10809	6	128.00	51
OM 314.950	Diesel	3782	4	97.00	18	OM 346.918	Diesel	10809	6	128.00	51
OM 314.951	Diesel	3782	4	97.00	18	OM 346.941	Diesel	10809	6	128.00	51
OM 314.953	Diesel	3782	4	97.00	18	OM 346.942	Diesel	10809	6	128.00	51
OM 314.954	Diesel	3782	4	97.00	18	OM 346.943	Diesel	10809	6	128.00	51
OM 314.956	Diesel	3782	4	97.00	18	OM 346.944	Diesel	10809	6	128.00	51
OM 314.957	Diesel	3782	4	97.00	18	OM 346.945	Diesel	10809	6	128.00	51
OM 314.958	Diesel	3782	4	97.00	18	OM 346.946	Diesel	10809	6	128.00	51
OM 314.959	Diesel	3782	4	97.00	18	OM 346.952	Diesel	10809	6	128.00	51
OM 314.960	Diesel	3782	4	97.00	18	OM 346.953	Diesel	10809	6	128.00	51
OM 314.961	Diesel	3782	4	97.00	18	OM 352 A	Diesel	5673	6	97.00	28
OM 314.962	Diesel	3782	4	97.00	18	OM 352.901	Diesel	5673	6	97.00	27
OM 314.963	Diesel	3782	4	97.00	18	OM 352.902	Diesel	5673	6	97.00	27
OM 314.964	Diesel	3782	4	97.00	18	OM 352.903	Diesel	5673	6	97.00	27
OM 314.965	Diesel	3782	4	97.00	18	OM 352.904	Diesel	5673	6	97.00	27
OM 314.967	Diesel	3782	4	97.00	18	OM 352.905	Diesel	5673	6	97.00	27
OM 314.968	Diesel	3782	4	97.00	18	OM 352.906	Diesel	5673	6	97.00	27
OM 314.970	Diesel	3782	4	97.00	18	OM 352.907	Diesel	5673	6	97.00	27
OM 326.910	Diesel	10809	6	128.00	50	OM 352.908	Diesel	5673	6	97.00	27
OM 326.911	Diesel	10809	6	128.00	50	OM 352.909	Diesel	5673	6	97.00	27
OM 326.912	Diesel	10809	6	128.00	50	OM 352.910	Diesel	5673	6	97.00	27
OM 326.914	Diesel	10809	6	128.00	50	OM 352.911	Diesel	5673	6	97.00	27
OM 326.915	Diesel	10809	6	128.00	50	OM 352.912	Diesel	5673	6	97.00	27
OM 326.918	Diesel	10809	6	128.00	50	OM 352.913	Diesel	5673	6	97.00	28
OM 326.971	Diesel	10809	6	128.00	50	OM 352.914	Diesel	5673	6	97.00	27
OM 326.972	Diesel	10809	6	128.00	50	OM 352.915	Diesel	5673	6	97.00	27
OM 326.973	Diesel	10809	6	128.00	50	OM 352.916	Diesel	5673	6	97.00	28
OM 326.974	Diesel	10809	6	128.00	50	OM 352.917	Diesel	5673	6	97.00	27
OM 326.975	Diesel	10809	6	128.00	50	OM 352.918	Diesel	5673	6	97.00	28
OM 326.977	Diesel	10809	6	128.00	50	OM 352.919	Diesel	5673	6	97.00	27
OM 326.980	Diesel	10809	6	128.00	50	OM 352.930	Diesel	5673	6	97.00	27
OM 326.983	Diesel	10809	6	128.00	50	OM 352.931	Diesel	5673	6	97.00	27
OM 326.988	Diesel	10809	6	128.00	50	OM 352.932	Diesel	5673	6	97.00	27
OM 327.910	Diesel	7980	6	115.00	42	OM 352.933	Diesel	5673	6	97.00	27
OM 327.914	Diesel	7980	6	115.00	42	OM 352.934	Diesel	5673	6	97.00	27
OM 327.915	Diesel	7980	6	115.00	42	OM 352.935	Diesel	5673	6	97.00	27
OM 327.916	Diesel	7980	6	115.00	42	OM 352.936	Diesel	5673	6	97.00	27
OM 327.917	Diesel	7980	6	115.00	42	OM 352.937	Diesel	5673	6	97.00	28
OM 327.918	Diesel	7980	6	115.00	42	OM 352.938	Diesel	5673	6	97.00	27
OM 327.919	Diesel	7980	6	115.00	42	OM 352.939	Diesel	5673	6	97.00	27
OM 327.931	Diesel	7980	6	115.00	42	OM 352.942	Diesel	5673	6	97.00	27
OM 327.932	Diesel	7980	6	115.00	42	OM 352.943	Diesel	5673	6	97.00	27









		cc			9			cc			9
OM 355.980	Diesel	11581	6	128.00	57	OM 357.913	Diesel	5958	6	97.50	32
OM 355.981	Diesel	11581	6	128.00	57	OM 357.915	Diesel	5958	6	97.50	30
OM 355.982	Diesel	11581	6	128.00	57	OM 357.916	Diesel	5958	6	97.50	30
OM 355.983	Diesel	11581	6	128.00	57	OM 357.917	Diesel	5958	6	97.50	30
OM 355.984	Diesel	11581	6	128.00	57	OM 357.918	Diesel	5958	6	97.50	30
OM 356.901	Diesel	5958	6	97.50	30	OM 357.919	Diesel	5958	6	97.50	30
OM 356.902	Diesel	5958	6	97.50	30	OM 357.920	Diesel	5958	6	97.50	35
OM 356.903	Diesel	5958	6	97.50	33	OM 357.921	Diesel	5958	6	97.50	35
OM 356.904	Diesel	5958	6	97.50	30	OM 357.922	Diesel	5958	6	97.50	35
OM 356.905	Diesel	5958	6	97.50	30	OM 357.924	Diesel	5958	6	97.50	36
OM 356.906	Diesel	5958	6	97.50	30	OM 357.925	Diesel	5958	6	97.50	35
OM 356.907	Diesel	5958	6	97.50	30	OM 357.926	Diesel	5958	6	97.50	35
OM 356.908	Diesel	5958	6	97.50	30	OM 357.927	Diesel	5958	6	97.50	35
OM 356.909	Diesel	5958	6	97.50	33	OM 357.929	Diesel	5958	6	97.50	35
OM 356.910	Diesel	5958	6	97.50	30	OM 357.930	Diesel	5958	6	97.50	35
OM 356.911	Diesel	5958	6	97.50	30	OM 357.931	Diesel	5958	6	97.50	35
OM 356.912	Diesel	5958	6	97.50	32	OM 357.932	Diesel	5958	6	97.50	35
OM 356.913	Diesel	5958	6	97.50	30	OM 357.933	Diesel	5958	6	97.50	35
OM 356.914	Diesel	5958	6	97.50	32	OM 357.936	Diesel	5958	6	97.50	35
OM 356.915	Diesel	5958	6	97.50	30	OM 357.937	Diesel	5958	6	97.50	35
OM 356.916	Diesel	5958	6	97.50	33	OM 357.938	Diesel	5958	6	97.50	35
OM 356.940	Diesel	5958	6	97.50	30	OM 357.940	Diesel	5958	6	97.50	35
OM 356.941	Diesel	5958	6	97.50	33	OM 357.941	Diesel	5958	6	97.50	35
OM 356.943	Diesel	5958	6	97.50	30	OM 357.942	Diesel	5958	6	97.50	35
OM 356.944	Diesel	5958	6	97.50	30	OM 357.943	Diesel	5958	6	97.50	37
OM 356.945	Diesel	5958	6	97.50	33	OM 357.944	Diesel	5958	6	97.50	37
OM 356.946	Diesel	5958	6	97.50	30	OM 357.945	Diesel	5958	6	97.50	36
OM 356.947	Diesel	5958	6	97.50	33	OM 357.946	Diesel	5958	6	97.50	35
OM 356.948	Diesel	5958	6	97.50	30	OM 357.947	Diesel	5958	6	97.50	35
OM 356.949	Diesel	5958	6	97.50	30	OM 357.948	Diesel	5958	6	97.50	35
OM 356.950	Diesel	5958	6	97.50	32	OM 357.949	Diesel	5958	6	97.50	35
OM 356.951	Diesel	5958	6	97.50	30	OM 357.961	Diesel	5958	6	97.50	35
OM 356.952	Diesel	5958	6	97.50	33	OM 357.962	Diesel	5958	6	97.50	35
OM 356.953	Diesel	5958	6	97.50	30	OM 357.963	Diesel	5958	6	97.50	30
OM 356.954	Diesel	5958	6	97.50	32	OM 360.911	Diesel	8725	6	115.00	43
OM 356.955	Diesel	5958	6	97.50	32	OM 360.914	Diesel	8725	6	115.00	43
OM 356.956	Diesel	5958	6	97.50	32	OM 360.915	Diesel	8725	6	115.00	43
OM 356.957	Diesel	5958	6	97.50	32	OM 360.916	Diesel	8725	6	115.00	43
OM 356.958	Diesel	5958	6	97.50	30	OM 360.917	Diesel	8725	6	115.00	43
OM 356.959	Diesel	5958	6	97.50	33	OM 360.918	Diesel	8725	6	115.00	43
OM 356.977	Diesel	5958	6	97.50	35	OM 360.931	Diesel	8725	6	115.00	43
OM 356.978	Diesel	5958	6	97.50	30	OM 360.933	Diesel	8725	6	115.00	43
OM 356.979	Diesel	5958	6	97.50	35	OM 360.935	Diesel	8725	6	115.00	43
OM 356.980	Diesel	5958	6	97.50	35	OM 360.936	Diesel	8725	6	115.00	43
OM 356.981	Diesel	5958	6	97.50	32	OM 360.937	Diesel	8725	6	115.00	43
OM 356.983	Diesel	5958	6	97.50	35	OM 360.938	Diesel	8725	6	115.00	43
OM 356.984	Diesel	5958	6	97.50	30	OM 360.939	Diesel	8725	6	115.00	43
OM 356.985	Diesel	5958	6	97.50	30	OM 360.940	Diesel	8725	6	115.00	43
OM 356.986	Diesel	5958	6	97.50	30	OM 360.941	Diesel	8725	6	115.00	43
OM 356.987	Diesel	5958	6	97.50	30	OM 360.942	Diesel	8725	6	115.00	43
OM 356.988	Diesel	5958	6	97.50	35	OM 360.943	Diesel	8725	6	115.00	43
OM 356.989	Diesel	5958	6	97.50	37	OM 360.944	Diesel	8725	6	115.00	43
OM 356.990	Diesel	5958	6	97.50	30	OM 360.946	Diesel	8725	6	115.00	43
OM 356.991	Diesel	5958	6	97.50	37	OM 360.948	Diesel	8725	6	115.00	43
OM 356.992	Diesel	5958	6	97.50	30	OM 360.949	Diesel	8725	6	115.00	43
OM 356.993	Diesel	5958	6	97.50	30	OM 360.950	Diesel	8725	6	115.00	43
OM 356.994	Diesel	5958	6	97.50	33	OM 360.951	Diesel	8725	6	115.00	43
OM 356.995	Diesel	5958	6	97.50	33	OM 360.952	Diesel	8725	6	115.00	43
OM 356.996	Diesel	5958	6	97.50	35	OM 360.960	Diesel	8725	6	115.00	43
OM 356.997	Diesel	5958	6	97.50	32	OM 360.961	Diesel	8725	6	115.00	43
OM 356.998	Diesel	5958	6	97.50	32	OM 360.962	Diesel	8725	6	115.00	43
OM 356.999	Diesel	5958	6	97.50	35	OM 360.963	Diesel	8725	6	115.00	43
OM 357.900	Diesel	5958	6	97.50	30	OM 360.964	Diesel	8725	6	115.00	43
OM 357.901	Diesel	5958	6	97.50	30	OM 360.965	Diesel	8725	6	115.00	43
OM 357.902	Diesel	5958	6	97.50	30	OM 360.966	Diesel	8725	6	115.00	43
OM 357.903	Diesel	5958	6	97.50	30	OM 360.967	Diesel	8725	6	115.00	43
OM 357.904	Diesel	5958	6	97.50	30	OM 360.968	Diesel	8725	6	115.00	43
OM 357.906	Diesel	5958	6	97.50	33	OM 360.969	Diesel	8725	6	115.00	43
OM 357.907	Diesel	5958	6	97.50	33	OM 360.970	Diesel	8725	6	115.00	43
OM 357.908	Diesel	5958	6	97.50	30	OM 360.971	Diesel	8725	6	115.00	43
OM 357.909	Diesel	5958	6	97.50	33	OM 360.972	Diesel	8725	6	115.00	43
OM 357.910	Diesel	5958	6	97.50	33	OM 360.973	Diesel	8725	6	115.00	43
OM 357.912	Diesel	5958	6	97.50	32	OM 360.975	Diesel	8725	6	115.00	43









		CC			9			CC			9
OM 360.979	Diesel	8725	6	115.00	43	OM 366.944	Diesel	5958	6	97.50	33
OM 360.980	Diesel	8725	6	115.00	43	OM 366.945	Diesel	5958	6	97.50	30
OM 360.981	Diesel	8725	6	115.00	43	OM 366.946	Diesel	5958	6	97.50	30
OM 360.982	Diesel	8725	6	115.00	43	OM 366.947	Diesel	5958	6	97.50	31
OM 360.983	Diesel	8725	6	115.00	43	OM 366.948	Diesel	5958	6	97.50	31
OM 360.984	Diesel	8725	6	115.00	43	OM 366.949	Diesel	5958	6	97.50	31
OM 360.985	Diesel	8725	6	115.00	43	OM 366.951	Diesel	5958	6	97.50	30
OM 360.986	Diesel	8725	6	115.00	43	OM 366.952	Diesel	5958	6	97.50	30
OM 362.906	Diesel	5675	6	97.00	29	OM 366.953	Diesel	5958	6	97.50	30
OM 362.909	Diesel	5675	6	97.00	29	OM 366.954	Diesel	5958	6	97.50	31
OM 362.910	Diesel	5675	6	97.00	29	OM 366.955	Diesel	5958	6	97.50	31
OM 364.901	Diesel	3972	4	97.50	19	OM 366.956	Diesel	5958	6	97.50	31
OM 364.905	Diesel	3972	4	97.50	19	OM 366.957	Diesel	5958	6	97.50	30
OM 364.906	Diesel	3972	4	97.50	19	OM 366.958	Diesel	5958	6	97.50	31
OM 364.907	Diesel	3972	4	97.50	19	OM 366.960	Diesel	5958	6	97.50	30
OM 364.908	Diesel	3972	4	97.50	19	OM 366.962	Diesel	5958	6	97.50	30
OM 364.909	Diesel	3972	4	97.50	19	OM 366.963	Diesel	5958	6	97.50	31
OM 364.911	Diesel	3972	4	97.50	19	OM 366.965	Diesel	5958	6	97.50	30
OM 364.912	Diesel	3972	4	97.50	19	OM 366.966	Diesel	5958	6	97.50	33
OM 364.913	Diesel	3972	4	97.50	19	OM 366.967	Diesel	5958	6	97.50	30
OM 364.914	Diesel	3972	4	97.50	19	OM 366.968	Diesel	5958	6	97.50	30
OM 364.916	Diesel	3972	4	97.50	19	OM 366.969	Diesel	5958	6	97.50	30
OM 364.917	Diesel	3972	4	97.50	19	OM 366.970	Diesel	5958	6	97.50	30
OM 364.918	Diesel	3972	4	97.50	19	OM 366.971	Diesel	5958	6	97.50	30
OM 364.919	Diesel	3972	4	97.50	19	OM 366.973	Diesel	5958	6	97.50	30
OM 364.920	Diesel	3972	4	97.50	19	OM 366.974	Diesel	5958	6	97.50	33
OM 364.921	Diesel	3972	4	97.50	19	OM 366.975	Diesel	5958	6	97.50	33
OM 364.950	Diesel	3972	4	97.50	19	OM 366.976	Diesel	5958	6	97.50	33
OM 364.951	Diesel	3972	4	97.50	19	OM 366.977	Diesel	5958	6	97.50	31
OM 364.952	Diesel	3972	4	97.50	19	OM 366.978	Diesel	5958	6	97.50	33
OM 364.953	Diesel	3972	4	97.50	19	OM 366.979	Diesel	5958	6	97.50	30
OM 364.954	Diesel	3972	4	97.50	19	OM 366.980	Diesel	5958	6	97.50	30
OM 364.955	Diesel	3972	4	97.50	19	OM 366.981	Diesel	5958	6	97.50	30
OM 364.956	Diesel	3972	4	97.50	19	OM 366.983	Diesel	5958	6	97.50	30
OM 364.957	Diesel	3972	4	97.50	19	OM 366.984	Diesel	5958	6	97.50	31
OM 364.958	Diesel	3972	4	97.50	19	OM 366.988	Diesel	5958	6	97.50	30
OM 364.959	Diesel	3972	4	97.50	19	OM 366.990	Diesel	5958	6	97.50	30
OM 364.980	Diesel	3972	4	97.50	19	OM 366.992	Diesel	5958	6	97.50	33
OM 364.981	Diesel	3972	4	97.50	19	OM 366.993	Diesel	5958	6	97.50	30
OM 364.982	Diesel	3972	4	97.50	19	OM 366.994	Diesel	5958	6	97.50	33
OM 364.983	Diesel	3972	4	97.50	19	OM 366.995	Diesel	5958	6	97.50	30
OM 364.984	Diesel	3972	4	97.50	19	OM 366.996	Diesel	5958	6	97.50	30
OM 364.985	Diesel	3972	4	97.50	19	OM 366.997	Diesel	5958	6	97.50	30
OM 364.986	Diesel	3972	4	97.50	19	OM 366.999	Diesel	5958	6	97.50	35
OM 364.987	Diesel	3972	4	97.50	19	OM 374.907	Diesel	3972	4	97.50	19
OM 364.989	Diesel	3972	4	97.50	19	OM 376.905	Diesel	5958	6	97.50	30
OM 366.905	Diesel	5958	6	97.50	30	OM 376.906	Diesel	5958	6	97.50	30
OM 366.906	Diesel	5958	6	97.50	30	OM 376.907	Diesel	5958	6	97.50	30
OM 366.907	Diesel	5958	6	97.50	30	OM 376.908	Diesel	5958	6	97.50	30
OM 366.908	Diesel	5958	6	97.50	31	OM 376.909	Diesel	5958	6	97.50	30
OM 366.909	Diesel	5958	6	97.50	30	OM 376.910	Diesel	5958	6	97.50	30
OM 366.910	Diesel	5958	6	97.50	30	OM 376.930	Diesel	5958	6	97.50	30
OM 366.911	Diesel	5958	6	97.50	30	OM 376.941	Diesel	5958	6	97.50	35
OM 366.912	Diesel	5958	6	97.50	31	OM 376.945	Diesel	5958	6	97.50	35
OM 366.913	Diesel	5958	6	97.50	30	OM 376.946	Diesel	5958	6	97.50	35
OM 366.914	Diesel	5958	6	97.50	30	OM 376.947	Diesel	5958	6	97.50	35
OM 366.915	Diesel	5958	6	97.50	31	OM 376.950	Diesel	5958	6	97.50	35
OM 366.917	Diesel	5958	6	97.50	30	OM 376.951	Diesel	5958	6	97.50	35
OM 366.918	Diesel	5958	6	97.50	33	OM 376.952	Diesel	5958	6	97.50	35
OM 366.919	Diesel	5958	6	97.50	30	OM 376.953	Diesel	5958	6	97.50	35
OM 366.930	Diesel	5958	6	97.50	30	OM 376.954	Diesel	5958	6	97.50	35
OM 366.931	Diesel	5958	6	97.50	33	OM 376.955	Diesel	5958	6	97.50	35
OM 366.932	Diesel	5958	6	97.50	30	OM 376.956	Diesel	5958	6	97.50	35
OM 366.933	Diesel	5958	6	97.50	30	OM 376.957	Diesel	5958	6	97.50	35
OM 366.935	Diesel	5958	6	97.50	33	OM 376.958	Diesel	5958	6	97.50	35
OM 366.936	Diesel	5958	6	97.50	30	OM 376.961	Diesel	5958	6	97.50	35
OM 366.937	Diesel	5958	6	97.50	33	OM 376.962	Diesel	5958	6	97.50	35
OM 366.938	Diesel	5958	6	97.50	30	OM 376.963	Diesel	5958	6	97.50	35
OM 366.939	Diesel	5958	6	97.50	31	OM 376.964	Diesel	5958	6	97.50	35
OM 366.940	Diesel	5958	6	97.50	30	OM 376.967	Diesel	5958	6	97.50	35
OM 366.941	Diesel	5958	6	97.50	30	OM 376.968	Diesel	5958	6	97.50	35
OM 366.942	Diesel	5958	6	97.50	30	OM 376.969	Diesel	5958	6	97.50	35
OM 366.943	Diesel	5958	6	97.50	30	OM 376.970	Diesel	5958	6	97.50	35

		cc			9			cc			9
OM 376.972	Diesel	5958	6	97.50	35	OM 401.985	Diesel	9572	6	125.00	46
OM 376.975	Diesel	5958	6	97.50	35	OM 401.986	Diesel	9572	6	125.00	46
OM 376.976	Diesel	5958	6	97.50	35	OM 401.987	Diesel	9572	6	125.00	46
OM 376.977	Diesel	5958	6	97.50	35	OM 401.989	Diesel	9572	6	125.00	46
OM 376.980	Diesel	5958	6	97.50	35	OM 401.990	Diesel	9572	6	125.00	46
OM 376.981	Diesel	5958	6	97.50	35	OM 401.991	Diesel	9572	6	125.00	46
OM 376.982	Diesel	5958	6	97.50	35	OM 401.992	Diesel	9572	6	125.00	46
OM 376.984	Diesel	5958	6	97.50	35	OM 401.993	Diesel	9572	6	125.00	46
OM 376.986	Diesel	5958	6	97.50	35	OM 401.994	Diesel	9572	6	125.00	46
OM 376.987	Diesel	5958	6	97.50	35	OM 402.905	Diesel	12763	8	125.00	83
OM 376.988	Diesel	5958	6	97.50	35	OM 402.906	Diesel	12763	8	125.00	83
OM 376.989	Diesel	5958	6	97.50	35	OM 402.907	Diesel	12763	8	125.00	83
OM 376.993	Diesel	5958	6	97.50	35	OM 402.910	Diesel	12763	8	125.00	83
OM 376.994	Diesel	5958	6	97.50	35	OM 402.911	Diesel	12763	8	125.00	83
OM 376.995	Diesel	5958	6	97.50	35	OM 402.912	Diesel	12763	8	125.00	83
OM 376.997	Diesel	5958	6	97.50	35	OM 402.913	Diesel	12763	8	125.00	83
OM 376.998	Diesel	5958	6	97.50	35	OM 402.914	Diesel	12763	8	125.00	83
OM 376.999	Diesel	5958	6	97.50	35	OM 402.916	Diesel	12763	8	125.00	83
OM 380.940	Diesel	3972	4	97.50	20	OM 402.917	Diesel	12763	8	125.00	83
OM 380.942	Diesel	3972	4	97.50	20	OM 402.919	Diesel	12763	8	125.00	83
OM 380.943	Diesel	3972	4	97.50	20	OM 402.921	Diesel	12763	8	125.00	83
OM 382.912	Diesel	5958	6	97.50	30	OM 402.923	Diesel	12763	8	125.00	83
OM 382.913	Diesel	5958	6	97.50	30	OM 402.924	Diesel	12763	8	125.00	83
OM 382.916	Diesel	5958	6	97.50	34	OM 402.925	Diesel	12763	8	125.00	83
OM 382.917	Diesel	5958	6	97.50	34	OM 402.926	Diesel	12763	8	125.00	83
OM 382.919	Diesel	5958	6	97.50	30	OM 402.927	Diesel	12763	8	125.00	83
OM 382.950	Diesel	5958	6	97.50	34	OM 402.928	Diesel	12763	8	125.00	83
OM 382.970	Diesel	5958	6	97.50	35	OM 402.970	Diesel	12763	8	125.00	84
OM 382.971	Diesel	5958	6	97.50	30	OM 402.971	Diesel	12763	8	125.00	84
OM 384.907	Diesel	3972	4	97.50	20	OM 402.972	Diesel	12763	8	125.00	84
OM 384.908	Diesel	3972	4	97.50	20	OM 402.973	Diesel	12763	8	125.00	84
OM 386.906	Diesel	5958	6	97.50	30	OM 402.974	Diesel	12763	8	125.00	84
OM 386.950	Diesel	5958	6	97.50	35	OM 402.975	Diesel	12763	8	125.00	84
OM 386.951	Diesel	5958	6	97.50	35	OM 402.977	Diesel	12763	8	125.00	84
OM 386.952	Diesel	5958	6	97.50	35	OM 402.978	Diesel	12763	8	125.00	84
OM 386.980	Diesel	5958	6	97.50	35	OM 402.982	Diesel	12763	8	125.00	84
OM 386.981	Diesel	5958	6	97.50	35	OM 402.983	Diesel	12763	8	125.00	84
OM 386.983	Diesel	5958	6	97.50	35	OM 402.984	Diesel	12763	8	125.00	84
OM 401.905	Diesel	9572	6	125.00	45	OM 402.985	Diesel	12763	8	125.00	84
OM 401.906	Diesel	9572	6	125.00	45	OM 402.986	Diesel	12763	8	125.00	84
OM 401.907	Diesel	9572	6	125.00	45	OM 402.987	Diesel	12763	8	125.00	84
OM 401.908	Diesel	9572	6	125.00	45	OM 402.989	Diesel	12763	8	125.00	84
OM 401.909	Diesel	9572	6	125.00	45	OM 402.990	Diesel	12763	8	125.00	84
OM 401.912	Diesel	9572	6	125.00	45	OM 402.995	Diesel	12763	8	125.00	84
OM 401.913	Diesel	9572	6	125.00	45	OM 402.996	Diesel	12763	8	125.00	84
OM 401.914	Diesel	9572	6	125.00	45	OM 403.905	Diesel	15950	10	125.00	90
OM 401.915	Diesel	9572	6	125.00	45	OM 403.906	Diesel	15950	10	125.00	90
OM 401.916	Diesel	9572	6	125.00	45	OM 403.915	Diesel	15950	10	125.00	90
OM 401.917	Diesel	9572	6	125.00	45	OM 403.916	Diesel	15950	10	125.00	90
OM 401.918	Diesel	9572	6	125.00	45	OM 403.917	Diesel	15950	10	125.00	90
OM 401.919	Diesel	9572	6	125.00	45	OM 403.918	Diesel	15950	10	125.00	90
OM 401.921	Diesel	9572	6	125.00	45	OM 403.919	Diesel	15950	10	125.00	90
OM 401.922	Diesel	9572	6	125.00	45	OM 403.930	Diesel	15950	10	125.00	90
OM 401.923	Diesel	9572	6	125.00	45	OM 403.931	Diesel	15950	10	125.00	90
OM 401.924	Diesel	10456	6	125.00	49	OM 403.932	Diesel	15950	10	125.00	90
OM 401.925	Diesel	9572	6	125.00	45	OM 403.933	Diesel	15950	10	125.00	90
OM 401.926	Diesel	9572	6	125.00	45	OM 403.934	Diesel	15950	10	125.00	90
OM 401.927	Diesel	9572	6	125.00	45	OM 403.935	Diesel	15950	10	125.00	90
OM 401.928	Diesel	9572	6	125.00	45	OM 404	Diesel	20911	12	125.00	94
OM 401.970	Diesel	9572	6	125.00	46	OM 404 A	Diesel	20911	12	125.00	94
OM 401.972	Diesel	9572	6	125.00	46	OM 407.905	Diesel	11045	6	125.00	54
OM 401.973	Diesel	9572	6	125.00	46	OM 407.907	Diesel	11045	6	125.00	54
OM 401.974	Diesel	9572	6	125.00	46	OM 407.908	Diesel	11045	6	125.00	54
OM 401.975	Diesel	9572	6	125.00	46	OM 407.909	Diesel	11045	6	125.00	54
OM 401.976	Diesel	9572	6	125.00	46	OM 407.910	Diesel	11045	6	125.00	54
OM 401.977	Diesel	9572	6	125.00	46	OM 407.911	Diesel	11045	6	125.00	54
OM 401.978	Diesel	9572	6	125.00	46	OM 407.913	Diesel	11413	6	125.00	56
OM 401.979	Diesel	9572	6	125.00	46	OM 407.914	Diesel	11413	6	125.00	56
OM 401.980	Diesel	9572	6	125.00	46	OM 407.915	Diesel	11413	6	125.00	56
OM 401.981	Diesel	9572	6	125.00	46	OM 407.916	Diesel	11413	6	125.00	56
OM 401.982	Diesel	9572	6	125.00	46	OM 407.917	Diesel	11413	6	125.00	56
OM 401.983	Diesel	9572	6	125.00	46	OM 407.918	Diesel	11413	6	125.00	56
OM 401.984	Diesel	9572	6	125.00	46	OM 407.919	Diesel	11413	6	125.00	56

		CC			9			CC			9
OM 407.920	Diesel	11413	6	125.00	56	OM 440.942	Diesel	14618	8	128.00	87
OM 407.951	Diesel	11413	6	125.00	56	OM 440.943	Diesel	14618	8	128.00	87
OM 407.955	Diesel	11413	6	125.00	56	OM 440.945	Diesel	14618	8	128.00	87
OM 409.906	Diesel	9204	5	125.00	44	OM 440.948	Diesel	14618	8	128.00	87
OM 409.907	Diesel	9204	5	125.00	44	OM 440.949	Diesel	14618	8	128.00	87
OM 409.908	Diesel	9204	5	125.00	44	OM 440.970	Diesel	14618	8	128.00	87
OM 421.905	Diesel	10964	6	128.00	52	OM 440.971	Diesel	14618	8	128.00	87
OM 421.906	Diesel	10964	6	128.00	52	OM 440.972	Diesel	14618	8	128.00	87
OM 421.907	Diesel	10964	6	128.00	52	OM 440.973	Diesel	14618	8	128.00	87
OM 421.908	Diesel	10964	6	128.00	52	OM 440.974	Diesel	14618	8	128.00	87
OM 421.909	Diesel	10964	6	128.00	52	OM 440.975	Diesel	14618	8	128.00	87
OM 421.910	Diesel	10964	6	128.00	52	OM 440.976	Diesel	14618	8	128.00	87
OM 421.951	Diesel	10964	6	128.00	52	OM 440.978	Diesel	14618	8	128.00	87
OM 422.901	Diesel	14618	8	128.00	86	OM 440.979	Diesel	14618	8	128.00	87
OM 422.905	Diesel	14618	8	128.00	86	OM 440.980	Diesel	14618	8	128.00	87
OM 422.906	Diesel	14618	8	128.00	86	OM 440.981	Diesel	14618	8	128.00	87
OM 422.907	Diesel	14618	8	128.00	86	OM 440.982	Diesel	14618	8	128.00	87
OM 422.908	Diesel	14618	8	128.00	86	OM 440.983	Diesel	14618	8	128.00	87
OM 422.909	Diesel	14618	8	128.00	86	OM 440.984	Diesel	14618	8	128.00	87
OM 422.910	Diesel	14618	8	128.00	86	OM 440.985	Diesel	14618	8	128.00	87
OM 422.911	Diesel	14618	8	128.00	86	OM 440.986	Diesel	14618	8	128.00	87
OM 422.912	Diesel	14618	8	128.00	86	OM 440.987	Diesel	14618	8	128.00	87
OM 422.913	Diesel	14618	8	128.00	86	OM 440.988	Diesel	14618	8	128.00	87
OM 422.914	Diesel	14618	8	128.00	86	OM 440.989	Diesel	14618	8	128.00	87
OM 422.915	Diesel	14618	8	128.00	86	OM 440.990	Diesel	14618	8	128.00	87
OM 422.916	Diesel	14618	8	128.00	86	OM 440.991	Diesel	14618	8	128.00	87
OM 422.917	Diesel	14618	8	128.00	86	OM 441.905	Diesel	10964	6	130.00	52
OM 422.918	Diesel	14618	8	128.00	86	OM 441.906	Diesel	10964	6	130.00	52
OM 422.919	Diesel	14618	8	128.00	86	OM 441.907	Diesel	10964	6	130.00	52
OM 422.920	Diesel	14618	8	128.00	86	OM 441.908	Diesel	10964	6	130.00	52
OM 422.921	Diesel	14618	8	128.00	86	OM 441.909	Diesel	10964	6	130.00	52
OM 422.922	Diesel	14618	8	128.00	86	OM 441.910	Diesel	11309	6	130.00	55
OM 422.923	Diesel	14618	8	128.00	86	OM 441.911	Diesel	10964	6	130.00	52
OM 422.950	Diesel	14618	8	128.00	86	OM 441.912	Diesel	11309	6	130.00	55
OM 422.951	Diesel	14618	8	128.00	86	OM 441.913	Diesel	10964	6	130.00	52
OM 422.952	Diesel	14618	8	128.00	86	OM 441.914	Diesel	11309	6	130.00	55
OM 422.953	Diesel	14618	8	128.00	86	OM 441.915	Diesel	10964	6	130.00	52
OM 422.954	Diesel	14618	8	128.00	86	OM 441.916	Diesel	11309	6	130.00	55
OM 422.955	Diesel	14618	8	128.00	86	OM 441.917	Diesel	10964	6	130.00	52
OM 422.956	Diesel	14618	8	128.00	86	OM 441.918	Diesel	11309	6	130.00	55
OM 422.957	Diesel	14618	8	128.00	86	OM 441.919	Diesel	11309	6	130.00	55
OM 422.958	Diesel	14618	8	128.00	86	OM 441.920	Diesel	11309	6	130.00	55
OM 422.959	Diesel	14618	8	128.00	86	OM 441.921	Diesel	11309	6	130.00	55
OM 422.963	Diesel	14618	8	128.00	86	OM 441.922	Diesel	11309	6	130.00	55
OM 423.905	Diesel	18273	10	128.00	92	OM 441.923	Diesel	10964	6	130.00	52
OM 423.906	Diesel	18273	10	128.00	92	OM 441.924	Diesel	11309	6	130.00	55
OM 423.907	Diesel	18273	10	128.00	92	OM 441.925	Diesel	10964	6	130.00	52
OM 423.908	Diesel	18273	10	128.00	92	OM 441.926	Diesel	10964	6	130.00	52
OM 423.909	Diesel	18273	10	128.00	92	OM 441.927	Diesel	10964	6	130.00	52
OM 423.950	Diesel	18273	10	128.00	92	OM 441.932	Diesel	11309	6	130.00	55
OM 423.951	Diesel	18273	10	128.00	92	OM 441.933	Diesel	11309	6	130.00	55
OM 424.900	Diesel	21930	12	128.00	96	OM 441.950	Diesel	10964	6	128.00	53
OM 424.901	Diesel	21930	12	128.00	96	OM 441.951	Diesel	10964	6	128.00	53
OM 424.901-510	Diesel	21930	12	128.00	96	OM 441.952	Diesel	10964	6	128.00	53
OM 427.905	Diesel	11967	6	128.00	67	OM 441.953	Diesel	10964	6	128.00	53
OM 427.910	Diesel	11967	6	128.00	67	OM 441.960	Diesel	10964	6	128.00	53
OM 427.911	Diesel	11967	6	128.00	67	OM 441.961	Diesel	10964	6	128.00	53
OM 427.950	Diesel	11967	6	128.00	67	OM 441.962	Diesel	10964	6	128.00	53
OM 427.951	Diesel	11967	6	128.00	67	OM 441.980	Diesel	10964	6	128.00	53
OM 427.952	Diesel	11967	6	128.00	67	OM 441.981	Diesel	10964	6	128.00	53
OM 429.951	Diesel	9970	5	128.00	47	OM 441.982	Diesel	10964	6	128.00	53
OM 429.953	Diesel	9970	5	128.00	47	OM 441.983	Diesel	10964	6	128.00	53
OM 429.955	Diesel	9970	5	128.00	47	OM 441.985	Diesel	10964	6	128.00	53
OM 440.905	Diesel	15080	8	130.00	88	OM 441.986	Diesel	10964	6	128.00	53
OM 440.906	Diesel	15080	8	130.00	88	OM 441.987	Diesel	10964	6	128.00	53
OM 440.907	Diesel	15080	8	130.00	88	OM 441.988	Diesel	10964	6	128.00	53
OM 440.908	Diesel	15080	8	130.00	88	OM 441.989	Diesel	10964	6	128.00	53
OM 440.909	Diesel	15080	8	130.00	88	OM 441.990	Diesel	10964	6	128.00	53
OM 440.910	Diesel	15080	8	130.00	88	OM 441.991	Diesel	10964	6	128.00	53
OM 440.911	Diesel	15080	8	130.00	88	OM 441.992	Diesel	10964	6	128.00	53
OM 440.912	Diesel	15080	8	130.00	88	OM 441.993	Diesel	10964	6	128.00	53
OM 440.940	Diesel	14618	8	128.00	87	OM 441.994	Diesel	10964	6	128.00	53
OM 440.941	Diesel	14618	8	128.00	87	OM 441.995	Diesel	10964	6	128.00	53

		CC			9			CC			9
OM 447.910	Diesel	11967	6	128.00	68	OM 457.941	Diesel	11967	6	128.00	73
OM 447.911	Diesel	11967	6	128.00	68	OM 457.942	Diesel	11967	6	128.00	73
OM 447.912	Diesel	11967	6	128.00	68	OM 457.943	Diesel	11967	6	128.00	74
OM 447.913	Diesel	11967	6	128.00	68	OM 457.944	Diesel	11967	6	128.00	74
OM 447.914	Diesel	11967	6	128.00	68	OM 457.945	Diesel	11967	6	128.00	66
OM 447.947	Diesel	11967	6	128.00	69	OM 457.946	Diesel	11967	6	128.00	66
OM 447.948	Diesel	11967	6	128.00	69	OM 457.947	Diesel	11967	6	128.00	76
OM 447.949	Diesel	11967	6	128.00	69	OM 457.948	Diesel	11967	6	128.00	61
OM 447.950	Diesel	11967	6	128.00	68	OM 457.949	Diesel	11967	6	128.00	66
OM 447.951	Diesel	11967	6	128.00	68	OM 457.950	Diesel	11967	6	128.00	75
OM 447.952	Diesel	11967	6	128.00	68	OM 457.951	Diesel	11967	6	128.00	61
OM 447.953	Diesel	11967	6	128.00	68	OM 457.952	Diesel	11967	6	128.00	75
OM 447.954	Diesel	11967	6	128.00	68	OM 457.953	Diesel	11967	6	128.00	61
OM 447.955	Diesel	11967	6	128.00	68	OM 457.954	Diesel	11967	6	128.00	75
OM 447.956	Diesel	11967	6	128.00	68	OM 457.955	Diesel	11967	6	128.00	79
OM 447.957	Diesel	11967	6	128.00	71	OM 457.956	Diesel	11967	6	128.00	80
OM 447.958	Diesel	11967	6	128.00	68	OM 457.957	Diesel	11967	6	128.00	81
OM 447.959	Diesel	11967	6	128.00	71	OM 457.958	Diesel	11967	6	128.00	81
OM 447.960	Diesel	11967	6	128.00	69	OM 457.959	Diesel	11967	6	128.00	75
OM 447.968	Diesel	11967	6	128.00	68	OM 457.960	Diesel	11967	6	128.00	82
OM 447.970	Diesel	11967	6	128.00	68	OM 457.961	Diesel	11967	6	128.00	61
OM 447.971	Diesel	11967	6	128.00	68	OM 457.962	Diesel	11967	6	128.00	61
OM 447.972	Diesel	11967	6	128.00	69	OM 457.964	Diesel	11967	6	128.00	75
OM 447.973	Diesel	11967	6	128.00	69	OM 457.965	Diesel	11967	6	128.00	75
OM 447.974	Diesel	11967	6	128.00	69	OM 457.966	Diesel	11967	6	128.00	75
OM 447.975	Diesel	11967	6	128.00	69	OM 458.960	Diesel	11967	6	128.00	77
OM 447.976	Diesel	11967	6	128.00	69	OM 458.970	Diesel	11967	6	128.00	78
OM 447.977	Diesel	11967	6	128.00	69	OM 458.980	Diesel	11967	6	128.00	78
OM 447.978	Diesel	11967	6	128.00	69	OM 460.950	Diesel	12816	6	128.00	85
OM 447.979	Diesel	11967	6	128.00	69	OM 460.960	Diesel	12816	6	128.00	85
OM 447.980	Diesel	11967	6	128.00	68	OM 481.902	Diesel	10964	6	128.00	52
OM 447.981	Diesel	11967	6	128.00	68	OM 481.904	Diesel	10964	6	128.00	52
OM 447.982	Diesel	11967	6	128.00	68	OM 482.912	Diesel	14618	8	128.00	86
OM 447.983	Diesel	11967	6	128.00	68	OM 482.930	Diesel	14618	8	128.00	86
OM 447.984	Diesel	11967	6	128.00	71	OM 482.940	Diesel	14618	8	128.00	86
OM 447.985	Diesel	11967	6	128.00	68	OM 482.941	Diesel	14618	8	128.00	86
OM 447.986	Diesel	11967	6	128.00	71	OM 489.960	Diesel	9973	5	128.00	48
OM 447.987	Diesel	11967	6	128.00	68	OM 489.961	Diesel	9973	5	128.00	48
OM 447.988	Diesel	11967	6	128.00	68	OM 521.940	Diesel	11946	6	130.00	58
OM 447.990	Diesel	11967	6	128.00	68	OM 521.950	Diesel	11946	6	130.00	58
OM 447.991	Diesel	11967	6	128.00	68	OM 522.940	Diesel	15928	8	130.00	89
OM 447.992	Diesel	11967	6	128.00	68	OM 522.941	Diesel	15928	8	130.00	89
OM 447.993	Diesel	11967	6	128.00	68	OM 522.942	Diesel	15928	8	130.00	89
OM 447.994	Diesel	11967	6	128.00	68	OM 522.943	Diesel	15928	8	130.00	89
OM 447.995	Diesel	11967	6	128.00	69	OM 522.950	Diesel	15928	8	130.00	89
OM 447.996	Diesel	11967	6	128.00	69	OM 541.920	Diesel	11946	6	130.00	58
OM 447.998	Diesel	11967	6	128.00	69	OM 541.921	Diesel	11946	6	130.00	58
OM 447.999	Diesel	11967	6	128.00	69	OM 541.922	Diesel	11946	6	130.00	58
OM 457.914	Diesel	11967	6	128.00	59	OM 541.923	Diesel	11946	6	130.00	58
OM 457.915	Diesel	11967	6	128.00	60	OM 541.924	Diesel	11946	6	130.00	58
OM 457.916	Diesel	11967	6	128.00	59	OM 541.925	Diesel	11946	6	130.00	58
OM 457.917	Diesel	11967	6	128.00	61	OM 541.926	Diesel	11946	6	130.00	58
OM 457.918	Diesel	11967	6	128.00	61	OM 541.927	Diesel	11946	6	130.00	58
OM 457.919	Diesel	11967	6	128.00	62	OM 541.928	Diesel	11946	6	130.00	58
OM 457.920	Diesel	11967	6	128.00	59	OM 541.940	Diesel	11946	6	130.00	58
OM 457.922	Diesel	11967	6	128.00	63	OM 541.941	Diesel	11946	6	130.00	58
OM 457.923	Diesel	11967	6	128.00	59	OM 541.942	Diesel	11946	6	130.00	58
OM 457.924	Diesel	11967	6	128.00	64	OM 541.943	Diesel	11946	6	130.00	58
OM 457.925	Diesel	11967	6	128.00	65	OM 541.944	Diesel	11946	6	130.00	58
OM 457.926	Diesel	11967	6	128.00	65	OM 541.945	Diesel	11946	6	130.00	58
OM 457.927	Diesel	11967	6	128.00	59	OM 541.946	Diesel	11946	6	130.00	58
OM 457.928	Diesel	11967	6	128.00	64	OM 541.947	Diesel	11946	6	130.00	58
OM 457.929	Diesel	11967	6	128.00	65	OM 541.948	Diesel	11946	6	130.00	58
OM 457.931	Diesel	11967	6	128.00	65	OM 541.949	Diesel	11946	6	130.00	58
OM 457.932	Diesel	11967	6	128.00	59	OM 541.950	Diesel	11946	6	130.00	58
OM 457.933	Diesel	11967	6	128.00	72	OM 541.951	Diesel	11946	6	130.00	58
OM 457.934	Diesel	11967	6	128.00	72	OM 541.952	Diesel	11946	6	130.00	58
OM 457.935	Diesel	11967	6	128.00	72	OM 541.970	Diesel	11946	6	130.00	58
OM 457.936	Diesel	11967	6	128.00	66	OM 541.971	Diesel	11946	6	130.00	58
OM 457.937	Diesel	11967	6	128.00	76	OM 541.972	Diesel	11946	6	130.00	58
OM 457.938	Diesel	11967	6	128.00	72	OM 541.973	Diesel	11946	6	130.00	58
OM 457.939	Diesel	11967	6	128.00	66	OM 541.974	Diesel	11946	6	130.00	58
OM 457.940	Diesel	11967	6	128.00	66	OM 541.975	Diesel	11946	6	130.00	58

		cc			9			cc			9
OM 541.976	Diesel	11946	6	130.00	58	OM 900.918	Diesel	4249	4	102.00	23
OM 541.977	Diesel	11946	6	130.00	58	OM 900.919	Diesel	4249	4	102.00	23
OM 541.978	Diesel	11946	6	130.00	58	OM 900.920	Diesel	4249	4	102.00	23
OM 541.980	Diesel	11946	6	130.00	58	OM 900.921	Diesel	4249	4	102.00	23
OM 541.981	Diesel	11946	6	130.00	58	OM 900.922	Diesel	4249	4	102.00	23
OM 542.920	Diesel	15928	8	130.00	89	OM 902.910	Diesel	6374	6	102.00	38
OM 542.921	Diesel	15928	8	130.00	89	OM 902.911	Diesel	6374	6	102.00	38
OM 542.922	Diesel	15928	8	130.00	89	OM 902.912	Diesel	6374	6	102.00	38
OM 542.923	Diesel	15928	8	130.00	89	OM 902.913	Diesel	6374	6	102.00	38
OM 542.924	Diesel	15928	8	130.00	89	OM 902.914	Diesel	6374	6	102.00	38
OM 542.925	Diesel	15928	8	130.00	89	OM 902.915	Diesel	6374	6	102.00	38
OM 542.926	Diesel	15928	8	130.00	89	OM 902.916	Diesel	6374	6	102.00	38
OM 542.940	Diesel	15928	8	130.00	89	OM 902.917	Diesel	6374	6	102.00	38
OM 542.941	Diesel	15928	8	130.00	89	OM 902.918	Diesel	6374	6	102.00	38
OM 542.942	Diesel	15928	8	130.00	89	OM 902.919	Diesel	6374	6	102.00	38
OM 542.943	Diesel	15928	8	130.00	89	OM 902.920	Diesel	6374	6	102.00	38
OM 542.944	Diesel	15928	8	130.00	89	OM 902.921	Diesel	6374	6	102.00	38
OM 542.945	Diesel	15928	8	130.00	89	OM 902.922	Diesel	6374	6	102.00	38
OM 542.947	Diesel	15928	8	130.00	89	OM 902.923	Diesel	6374	6	102.00	38
OM 542.948	Diesel	15928	8	130.00	89	OM 902.927	Diesel	6374	6	102.00	38
OM 542.956	Diesel	15928	8	130.00	89	OM 902.930	Diesel	6374	6	102.00	38
OM 542.957	Diesel	15928	8	130.00	89	OM 902.931	Diesel	6374	6	102.00	38
OM 542.960	Diesel	15928	8	130.00	89	OM 902.932	Diesel	6374	6	102.00	38
OM 542.961	Diesel	15928	8	130.00	89	OM 902.933	Diesel	6374	6	102.00	38
OM 542.962	Diesel	15928	8	130.00	89	OM 904.904	Diesel	4249	4	102.00	21
OM 542.963	Diesel	15928	8	130.00	89	OM 904.905	Diesel	4249	4	102.00	21
OM 542.964	Diesel	15928	8	130.00	89	OM 904.906	Diesel	4249	4	102.00	21
OM 601.940	Diesel	2299	4	89.00	3	OM 904.907	Diesel	4249	4	102.00	21
OM 601.942	Diesel	2299	4	89.00	4	OM 904.908	Diesel	4249	4	102.00	21
OM 601.943	Diesel	2299	4	89.00	4	OM 904.909	Diesel	4249	4	102.00	21
OM 601A.970	Diesel	2299	4	89.00	5	OM 904.910	Diesel	4249	4	102.00	21
OM 602.938	Diesel	2497	5	87.00	10	OM 904.911	Diesel	4249	4	102.00	21
OM 602.940	Diesel	2874	5	89.00	11	OM 904.912	Diesel	4249	4	102.00	21
OM 602.941	Diesel	2874	5	89.00	11	OM 904.914	Diesel	4249	4	102.00	21
OM 602.942	Diesel	2874	5	89.00	12	OM 904.915	Diesel	4249	4	102.00	21
OM 602.948	Diesel	2874	5	89.00	11	OM 904.916	Diesel	4249	4	102.00	21
OM 602.980	Diesel	2874	5	89.00	14	OM 904.917	Diesel	4249	4	102.00	21
OM 602.981	Diesel	2874	5	89.00	15	OM 904.918	Diesel	4249	4	102.00	21
OM 602.982	Diesel	2874	5	89.00	14	OM 904.919	Diesel	4249	4	102.00	21
OM 602.983	Diesel	2874	5	89.00	14	OM 904.920	Diesel	4249	4	102.00	21
OM 602.984	Diesel	2874	5	89.00	14	OM 904.921	Diesel	4249	4	102.00	21
OM 602.985	Diesel	2874	5	89.00	14	OM 904.922	Diesel	4249	4	102.00	21
OM 602.989	Diesel	2874	5	89.00	15	OM 904.923	Diesel	4249	4	102.00	21
OM 602.991	Diesel	2874	5	89.00	11	OM 904.924	Diesel	4249	4	102.00	21
OM 602.994	Diesel	2874	5	89.00	13	OM 904.925	Diesel	4249	4	102.00	21
OM 615.912	Diesel	2197	4	87.00	2	OM 904.926	Diesel	4249	4	102.00	21
OM 615.913	Diesel	1988	4	87.00	1	OM 904.927	Diesel	4249	4	102.00	21
OM 615.917	Diesel	2197	4	87.00	2	OM 904.928	Diesel	4249	4	102.00	21
OM 615.937	Diesel	2197	4	87.00	2	OM 904.929	Diesel	4249	4	102.00	21
OM 615.939	Diesel	2197	4	87.00	2	OM 904.930	Diesel	4249	4	102.00	21
OM 615.940	Diesel	1988	4	87.00	1	OM 904.931	Diesel	4249	4	102.00	21
OM 615.941	Diesel	2197	4	87.00	2	OM 904.932	Diesel	4249	4	102.00	21
OM 616.912	Diesel	2404	4	91.00	9	OM 904.933	Diesel	4249	4	102.00	21
OM 616.916	Diesel	2404	4	91.00	9	OM 904.934	Diesel	4249	4	102.00	21
OM 616.917	Diesel	2404	4	91.00	9	OM 904.935	Diesel	4249	4	102.00	21
OM 616.932	Diesel	2404	4	91.00	8	OM 904.936	Diesel	4249	4	102.00	21
OM 616.933	Diesel	2404	4	91.00	8	OM 904.937	Diesel	4249	4	102.00	21
OM 616.934	Diesel	2399	4	90.90	7	OM 904.938	Diesel	4249	4	102.00	21
OM 616.936	Diesel	2399	4	90.90	7	OM 904.939	Diesel	4249	4	102.00	21
OM 616.937	Diesel	2399	4	90.90	7	OM 904.940	Diesel	4249	4	102.00	21
OM 616.939	Diesel	2399	4	90.90	7	OM 904.941	Diesel	4249	4	102.00	21
OM 616.942	Diesel	2399	4	90.90	6	OM 904.942	Diesel	4249	4	102.00	21
OM 616.943	Diesel	2399	4	90.90	6	OM 904.943	Diesel	4249	4	102.00	21
OM 617.910	Diesel	3005	5	91.00	17	OM 904.944	Diesel	4249	4	102.00	21
OM 617.912	Diesel	3005	5	91.00	17	OM 904.945	Diesel	4249	4	102.00	21
OM 617.913	Diesel	2998	5	90.90	16	OM 904.946	Diesel	4249	4	102.00	21
OM 617.931	Diesel	3005	5	90.90	17	OM 904.947	Diesel	4249	4	102.00	21
OM 617.952	Diesel	3005	5	90.90	17	OM 904.948	Diesel	4249	4	102.00	21
OM 900.910	Diesel	4249	4	102.00	23	OM 904.949	Diesel	4249	4	102.00	21
OM 900.911	Diesel	4249	4	102.00	22	OM 904.950	Diesel	4249	4	102.00	21
OM 900.912	Diesel	4249	4	102.00	22	OM 904.951	Diesel	4249	4	102.00	21
OM 900.913	Diesel	4249	4	102.00	22	OM 904.952	Diesel	4249	4	102.00	21
OM 900.917	Diesel	4249	4	102.00	23	OM 904.953	Diesel	4249	4	102.00	21

		cc			9			cc			9
OM 941.980	Diesel	11946	6	130.00	58						
OM 941.981	Diesel	11946	6	130.00	58						
OM 941.990	Diesel	11946	6	130.00	58						
OM 942.900	Diesel	15928	8	130.00	89						
OM 942.910	Diesel	15928	8	130.00	89						
OM 942.911	Diesel	15928	8	130.00	89						
OM 942.912	Diesel	15928	8	130.00	89						
OM 942.925	Diesel	15928	8	130.00	89						
OM 942.930	Diesel	15928	8	130.00	89						
OM 942.960	Diesel	15928	8	130.00	89						
OM 942.967	Diesel	15928	8	130.00	89						
OM 942.970	Diesel	15928	8	130.00	89						
OM 942.980	Diesel	15928	8	130.00	89						
OM 942.990	Diesel	15928	8	130.00	89						



21

9



21

9

ACCELO 915 C	05/03→	21	ACTROS 2653,2653 L	04/96→10/02	89
ACTROS 1831 AK	04/97→10/02	58	ACTROS 2657 K,2657 LK	04/97→10/02	89
ACTROS 1831 K	04/97→10/02	58	ACTROS 2657 L	04/97→10/02	89
ACTROS 1831 S,1831 LS	04/96→10/02	58	ACTROS 2657 S	04/97→10/02	89
ACTROS 1831,1831 L	04/96→10/02	58	ACTROS 3231 B	04/97→10/02	58
ACTROS 1835 AK	04/97→10/02	58	ACTROS 3231 K	04/97→10/02	58
ACTROS 1835 K	04/97→10/02	58	ACTROS 3235	04/97→10/02	58
ACTROS 1835 S,1835 LS	04/96→10/02	58	ACTROS 3235 B	04/97→10/02	58
ACTROS 1835,1835 L	04/96→10/02	58	ACTROS 3235 K	04/97→10/02	58
ACTROS 1840 AK	04/97→10/02	58	ACTROS 3240	04/97→10/02	58
ACTROS 1840 K	04/97→10/02	58	ACTROS 3240 B	04/97→10/02	58
ACTROS 1840 S,1840 LS	04/96→10/02	58	ACTROS 3240 K	04/97→10/02	58
ACTROS 1840,1840 L	04/96→10/02	58	ACTROS 3243	04/97→10/02	58
ACTROS 1843 AK	04/97→10/02	58	ACTROS 3243 B	04/97→10/02	58
ACTROS 1843 K	04/97→10/02	58	ACTROS 3243 K	04/97→10/02	58
ACTROS 1843 S,1843 LS	04/96→10/02	58	ACTROS 3331	04/97→10/02	58
ACTROS 1843,1843 L	04/96→10/02	58	ACTROS 3331 A	04/97→10/02	58
ACTROS 1848 AK	04/97→10/02	89	ACTROS 3331 AK	04/97→10/02	58
ACTROS 1848 K	04/97→10/02	89	ACTROS 3331 AS	04/97→10/02	58
ACTROS 1848 S,1848 LS	04/96→10/02	89	ACTROS 3331 B	04/97→10/02	58
ACTROS 1848,1848 L	04/96→10/02	89	ACTROS 3331 K	04/97→10/02	58
ACTROS 1853 S,1853 LS	04/96→10/02	89	ACTROS 3331 S	04/97→10/02	58
ACTROS 1853,1853 L	04/96→10/02	89	ACTROS 3335	04/97→10/02	58
ACTROS 1857 L	04/97→10/02	89	ACTROS 3335 B	04/97→10/02	58
ACTROS 1857 LS	04/97→10/02	89	ACTROS 3335 K	04/97→10/02	58
ACTROS 2031	04/97→10/02	58	ACTROS 3335 S	04/97→10/02	58
ACTROS 2031 A	04/97→10/02	58	ACTROS 3340	04/97→10/02	58
ACTROS 2031 AK	09/96→10/02	58	ACTROS 3340 A	04/97→10/02	58
ACTROS 2031 AS	04/96→10/02	58	ACTROS 3340 AK	04/97→10/02	58
ACTROS 2031 K	04/97→10/02	58	ACTROS 3340 AS	04/97→10/02	58
ACTROS 2031 S	04/96→10/02	58	ACTROS 3340 B	04/97→10/02	58
ACTROS 2035 A	04/97→10/02	58	ACTROS 3340 K	04/97→10/02	58
ACTROS 2035 S	04/96→10/02	58	ACTROS 3340 S	04/97→10/02	58
ACTROS 2040	09/96→10/02	58	ACTROS 3343	04/97→10/02	58
ACTROS 2040 AK	09/96→10/02	58	ACTROS 3343 AK	04/97→10/02	58
ACTROS 2040 AS	04/96→10/02	58	ACTROS 3343 AS	04/97→10/02	58
ACTROS 2040 S	04/96→10/02	58	ACTROS 3343 B	04/97→10/02	58
ACTROS 2043 AS	04/96→10/02	58	ACTROS 3343 K	04/97→10/02	58
ACTROS 2048 AS	04/96→10/02	89	ACTROS 3343 S	04/97→10/02	58
ACTROS 2053 S	04/96→10/02	89	ACTROS 3348	04/97→10/02	89
ACTROS 2531 LS	09/96→10/02	58	ACTROS 3348 AK	04/97→10/02	89
ACTROS 2531,2531 L	09/96→10/02	58	ACTROS 3348 AS	04/97→10/02	89
ACTROS 2535 L	09/96→10/02	58	ACTROS 3348 K	04/97→10/02	89
ACTROS 2535 LS	09/96→10/02	58	ACTROS 3348 S	04/97→10/02	89
ACTROS 2535 LS	04/97→10/02	58	ACTROS 3353	04/97→10/02	89
ACTROS 2540 LS	09/96→10/02	58	ACTROS 3353 AS	04/97→10/02	89
ACTROS 2540,2540 L	09/96→10/02	58	ACTROS 3353 S	04/97→10/02	89
ACTROS 2543 LS	09/96→10/02	58	ACTROS 3357	04/97→10/02	89
ACTROS 2543,2543 L	09/96→10/02	58	ACTROS 3357 S	04/97→10/02	89
ACTROS 2548 LS	09/96→10/02	89	ACTROS 4140 AK	04/97→10/02	58
ACTROS 2548,2548 L	09/96→10/02	89	ACTROS 4140 B	04/97→10/02	58
ACTROS 2553 LS	09/96→10/02	89	ACTROS 4140 K	04/97→10/02	58
ACTROS 2553,2553 L	09/96→10/02	89	ACTROS 4143 AK	04/97→10/02	58
ACTROS 2557 L	09/96→10/02	89	ACTROS 4143 K	04/97→10/02	58
ACTROS 2631 B	04/97→10/02	58	ACTROS 4148 AK	04/97→10/02	89
ACTROS 2631 K	04/97→10/02	58	ACTROS 4148 K	04/97→10/02	89
ACTROS 2631,2631 L	04/96→10/02	58	ACTROS MP2 / MP3 1832	04/03→	58
ACTROS 2635 B	04/97→10/02	58	ACTROS MP2 / MP3 1832 LS	04/03→	58
ACTROS 2635 K	04/97→10/02	58	ACTROS MP2 / MP3 1832, L, LL	04/03→	58
ACTROS 2635,2635 L	04/96→10/02	58	ACTROS MP2 / MP3 1836 AK	04/03→	58
ACTROS 2640 B	04/97→10/02	58	ACTROS MP2 / MP3 1836 K	04/03→	58
ACTROS 2640 K,2640 LK	04/97→10/02	58	ACTROS MP2 / MP3 1836 LS	04/03→	58
ACTROS 2640 S,2640 LS	09/96→10/02	58	ACTROS MP2 / MP3 1836, L, LL	04/03→	58
ACTROS 2640,2640 L	04/96→10/02	58	ACTROS MP2 / MP3 1841 A		58
ACTROS 2643 B	04/97→10/02	58	ACTROS MP2 / MP3 1841 K	04/03→	58
ACTROS 2643 K,2643 LK	04/97→10/02	58	ACTROS MP2 / MP3 1841 L, LL	04/03→	58
ACTROS 2643 S,2643 LS	04/97→10/02	58	ACTROS MP2 / MP3 1841, L, LL	04/03→	58
ACTROS 2643,2643 L	04/96→10/02	58	ACTROS MP2 / MP3 1844 A	04/03→	58
ACTROS 2648 K,2648 LK	04/97→10/02	89	ACTROS MP2 / MP3 1844 K	04/03→	58
ACTROS 2648 S,2648 LS	09/96→10/02	89	ACTROS MP2 / MP3 1844, L, LL	04/03→	58
ACTROS 2648,2648 L	04/96→10/02	89	ACTROS MP2 / MP3 1846 A	04/03→	58
ACTROS 2653 K,2653 LK	04/97→10/02	89	ACTROS MP2 / MP3 1846 K	04/03→	58
ACTROS 2653 S,2653 LS	09/96→10/02	89	ACTROS MP2 / MP3 1846 LS	04/03→	58



21

9

ACTROS MP2 / MP3 1846 LS, LLS	04/03→	58
ACTROS MP2 / MP3 1846, L, LL	04/03→	58
ACTROS MP2 / MP3 1848 A	04/03→	58
ACTROS MP2 / MP3 1848 AK	04/03→	58
ACTROS MP2 / MP3 1848 K	04/03→	58
ACTROS MP2 / MP3 1848 K	04/03→	89
ACTROS MP2 / MP3 1848 S, LS	04/03→	89
ACTROS MP2 / MP3 1848, L, LL	04/03→	58
ACTROS MP2 / MP3 1848, L, LL	04/03→	89
ACTROS MP2 / MP3 1848, L, LL	04/03→	89
ACTROS MP2 / MP3 1848, LS, LLS	04/03→	58
ACTROS MP2 / MP3 1850, 1851 AK	04/03→	89
ACTROS MP2 / MP3 1850, 1851 K	04/03→	89
ACTROS MP2 / MP3 1850, 1851 LS, LLS	04/03→	89
ACTROS MP2 / MP3 1850, 1851, L, LL	04/03→	89
ACTROS MP2 / MP3 1850, L, LL	04/03→	89
ACTROS MP2 / MP3 1851 A	04/03→	89
ACTROS MP2 / MP3 1854, L	04/03→	89
ACTROS MP2 / MP3 1854, L, LL	04/03→	89
ACTROS MP2 / MP3 1858, L	10/02→	89
ACTROS MP2 / MP3 1860 L, LL	05/05→	89
ACTROS MP2 / MP3 1860 LS	06/08→	89
ACTROS MP2 / MP3 2032	04/03→	58
ACTROS MP2 / MP3 2032 A, AE	04/03→	58
ACTROS MP2 / MP3 2032 AK	04/03→	58
ACTROS MP2 / MP3 2032 AS	04/03→	58
ACTROS MP2 / MP3 2032 K	04/03→	58
ACTROS MP2 / MP3 2032 S	04/03→	58
ACTROS MP2 / MP3 2036	04/03→	58
ACTROS MP2 / MP3 2036 A, AE	04/03→	58
ACTROS MP2 / MP3 2036 AK	04/03→	58
ACTROS MP2 / MP3 2036 AS	04/03→	58
ACTROS MP2 / MP3 2036 S	04/03→	58
ACTROS MP2 / MP3 2041	04/03→	58
ACTROS MP2 / MP3 2041 AK	04/03→	58
ACTROS MP2 / MP3 2041 AS	04/03→	58
ACTROS MP2 / MP3 2041 K	04/03→	58
ACTROS MP2 / MP3 2041 S	04/03→	58
ACTROS MP2 / MP3 2044	04/03→	58
ACTROS MP2 / MP3 2044 AK	04/03→	58
ACTROS MP2 / MP3 2044 AS	04/03→	58
ACTROS MP2 / MP3 2044 S	04/03→	58
ACTROS MP2 / MP3 2046	04/03→	58
ACTROS MP2 / MP3 2046 AK	04/03→	58
ACTROS MP2 / MP3 2046 AS	04/03→	58
ACTROS MP2 / MP3 2046 S	04/03→	58
ACTROS MP2 / MP3 2048 AK	04/03→	58
ACTROS MP2 / MP3 2048 AS	04/03→	58
ACTROS MP2 / MP3 2048 AS	04/03→	89
ACTROS MP2 / MP3 2050 S	04/03→	89
ACTROS MP2 / MP3 2051 AS	04/03→	89
ACTROS MP2 / MP3 2532 LS	04/03→	58
ACTROS MP2 / MP3 2532, L, LL	04/03→	58
ACTROS MP2 / MP3 2536 LS	04/03→	58
ACTROS MP2 / MP3 2536, L, LL	04/03→	58
ACTROS MP2 / MP3 2541 LS	04/03→	58
ACTROS MP2 / MP3 2541, L, LL	04/03→	58
ACTROS MP2 / MP3 2544 LS	04/03→	58
ACTROS MP2 / MP3 2544, L, LL	04/03→	58
ACTROS MP2 / MP3 2546 LS	04/03→	58
ACTROS MP2 / MP3 2546, L, LL	04/03→	58
ACTROS MP2 / MP3 2548 LS	04/03→	58
ACTROS MP2 / MP3 2548, L, LL	04/03→	58
ACTROS MP2 / MP3 2551 LS	04/03→	89
ACTROS MP2 / MP3 2555 LS	09/05→	89
ACTROS MP2 / MP3 2632 B	04/03→	58
ACTROS MP2 / MP3 2632 K, LK	04/03→	58
ACTROS MP2 / MP3 2632 LS	04/03→	58
ACTROS MP2 / MP3 2632, L, LL	04/03→	58
ACTROS MP2 / MP3 2636 B	04/03→	58
ACTROS MP2 / MP3 2636 K, LK	04/03→	58
ACTROS MP2 / MP3 2636 LS	04/03→	58
ACTROS MP2 / MP3 2636, L, LL	04/03→	58
ACTROS MP2 / MP3 2641 B	04/03→	58



21

9

ACTROS MP2 / MP3 2641 K, LK	04/03→	58
ACTROS MP2 / MP3 2641 S, LS	04/03→	58
ACTROS MP2 / MP3 2641, L, LL	04/03→	58
ACTROS MP2 / MP3 2644 B	04/03→	58
ACTROS MP2 / MP3 2644 K, LK	04/03→	58
ACTROS MP2 / MP3 2644 S, LS	04/03→	58
ACTROS MP2 / MP3 2644, L, LL	04/03→	58
ACTROS MP2 / MP3 2646 B	04/03→	58
ACTROS MP2 / MP3 2646 K, LK	04/03→	58
ACTROS MP2 / MP3 2646 S, LS	04/03→	58
ACTROS MP2 / MP3 2646, L, LL	04/03→	58
ACTROS MP2 / MP3 2648 B	04/03→	58
ACTROS MP2 / MP3 2648 K, LK	04/03→	58
ACTROS MP2 / MP3 2650 K, 2651 K, LK	04/03→	89
ACTROS MP2 / MP3 2650 S, LS	04/03→	89
ACTROS MP2 / MP3 2650, L, 2651, L, LL	04/03→	89
ACTROS MP2 / MP3 2654 K, LK, 2655 K, LK	04/03→	89
ACTROS MP2 / MP3 2654 S, LS	04/03→	89
ACTROS MP2 / MP3 2654, L, 2655, L, LL	04/03→	89
ACTROS MP2 / MP3 2658 K	04/03→	89
ACTROS MP2 / MP3 2658 L	04/03→	89
ACTROS MP2 / MP3 2658 LS	04/03→	89
ACTROS MP2 / MP3 3231 K, 3232 K	04/03→	58
ACTROS MP2 / MP3 3241	04/03→	58
ACTROS MP2 / MP3 3246 K	04/03→	58
ACTROS MP2 / MP3 3331 A, 3332 A	04/03→	58
ACTROS MP2 / MP3 3331 AK, 3332 AK	04/03→	58
ACTROS MP2 / MP3 3331 S, 3332 S	04/03→	58
ACTROS MP2 / MP3 3331, 3332	04/03→	58
ACTROS MP2 / MP3 3332 AK	04/03→	58
ACTROS MP2 / MP3 3332 AS	04/03→	58
ACTROS MP2 / MP3 3332 B	04/03→	58
ACTROS MP2 / MP3 3332 K	04/03→	58
ACTROS MP2 / MP3 3336	04/03→	58
ACTROS MP2 / MP3 3336 A	04/03→	58
ACTROS MP2 / MP3 3336 AK	04/03→	58
ACTROS MP2 / MP3 3336 AS	04/03→	58
ACTROS MP2 / MP3 3336 B	04/03→	58
ACTROS MP2 / MP3 3336 K	04/03→	58
ACTROS MP2 / MP3 3336 S	04/03→	58
ACTROS MP2 / MP3 3341	04/03→	58
ACTROS MP2 / MP3 3341 AK	04/03→	58
ACTROS MP2 / MP3 3341 AS	04/03→	58
ACTROS MP2 / MP3 3341 B	04/03→	58
ACTROS MP2 / MP3 3341 S	04/03→	58
ACTROS MP2 / MP3 3344	04/03→	58
ACTROS MP2 / MP3 3344 A	04/03→	58
ACTROS MP2 / MP3 3344 AK	04/03→	58
ACTROS MP2 / MP3 3344 AS	04/03→	58
ACTROS MP2 / MP3 3344 B	04/03→	58
ACTROS MP2 / MP3 3344 S	04/03→	58
ACTROS MP2 / MP3 3346	04/03→	58
ACTROS MP2 / MP3 3346 AK	04/03→	58
ACTROS MP2 / MP3 3346 AS	04/03→	58
ACTROS MP2 / MP3 3346 B	04/03→	58
ACTROS MP2 / MP3 3346 S	04/03→	58
ACTROS MP2 / MP3 3348	04/03→	58
ACTROS MP2 / MP3 3348	04/03→	89
ACTROS MP2 / MP3 3348 AK	04/03→	58
ACTROS MP2 / MP3 3348 AK	04/03→	89
ACTROS MP2 / MP3 3348 AS	04/03→	58
ACTROS MP2 / MP3 3348 AS	04/03→	89
ACTROS MP2 / MP3 3348 B	04/03→	58
ACTROS MP2 / MP3 3348 S	04/03→	58
ACTROS MP2 / MP3 3348 S	04/03→	89
ACTROS MP2 / MP3 3350 S	06/09→	89
ACTROS MP2 / MP3 3350, 3351	04/03→	89
ACTROS MP2 / MP3 3351 AK	04/03→	89
ACTROS MP2 / MP3 3351 AS	04/03→	89
ACTROS MP2 / MP3 3351 S	04/03→	89
ACTROS MP2 / MP3 3354, 3355	04/03→	89
ACTROS MP2 / MP3 3355 AS	04/03→	89
ACTROS MP2 / MP3 3355 S	04/03→	89



21

9



21

9

ACTROS MP2 / MP3 4140 AK	04/03→	58	ATEGO 2 1523, 1523 L, 1524, 1524 L	10/04→	38
ACTROS MP2 / MP3 4140 K	04/03→	58	ATEGO 2 1523, 1523 L, 1524, 1524 L	10/04→	39
ACTROS MP2 / MP3 4141 K	04/03→	58	ATEGO 2 1524 AK	10/04→	38
ACTROS MP2 / MP3 4144 K	04/03→	58	ATEGO 2 1526 AK	10/04→	38
ACTROS MP2 / MP3 4146 K	04/03→	58	ATEGO 2 1526 K	10/04→	38
ACTROS MP2 / MP3 4148 AK	04/03→	58	ATEGO 2 1526, 1526 L	10/04→	38
ACTROS MP2 / MP3 4148 B	04/03→	58	ATEGO 2 1528, 1528 L, 1529, 1529 L	10/04→	38
ACTROS MP2 / MP3 4148 K	04/03→	58	ATEGO 2 1528, 1528 L, 1529, 1529 L	10/04→	39
ACTROS MP2 / MP3 4151 K	05/05→	89	ATEGO 2 1529 AK	10/04→	38
ACTROS MP2 / MP3 4160 S	10/02→	89	ATEGO 2 1529 K	10/04→	38
ATEGO 2 1016 K	10/04→	22	ATEGO 2 1618		22
ATEGO 2 1016 K	10/04→	23	ATEGO 2 1618 K		22
ATEGO 2 1016, 1016 L	10/04→	22	ATEGO 2 1718	01/11→	21
ATEGO 2 1016, 1016 L	10/04→	23	ATEGO 2 1718	01/11→	22
ATEGO 2 1018 A	10/04→	22	ATEGO 2 1718 K	01/11→	21
ATEGO 2 1018 A	10/04→	23	ATEGO 2 1725	01/11→	39
ATEGO 2 1018 K	10/04→	22	ATEGO 2 1725 A	01/11→	39
ATEGO 2 1018 K	10/04→	23	ATEGO 2 1725 K	01/11→	39
ATEGO 2 1018, 1018 L	10/04→	22	ATEGO 2 1728	01/11→	39
ATEGO 2 1018, 1018 L	10/04→	23	ATEGO 2 2425	01/11→	39
ATEGO 2 1022 K	10/04→	26	ATEGO 2 2428	01/11→	39
ATEGO 2 1022, 1022 L	10/04→	26	ATEGO 2 712, 713	10/04→	21
ATEGO 2 1023 A, 1024 A	10/04→	38	ATEGO 2 712, 713	10/04→	22
ATEGO 2 1023 A, 1024 A	10/04→	39	ATEGO 2 712, 713	10/04→	23
ATEGO 2 1023, 1023 L, 1024, 1024 L	10/04→	38	ATEGO 2 715, 715 L, 716, 716 L	10/04→	21
ATEGO 2 1023, 1023 L, 1024, 1024 L	10/04→	39	ATEGO 2 715, 715 L, 716, 716 L	10/04→	22
ATEGO 2 1024 K	10/04→	38	ATEGO 2 715, 715 L, 716, 716 L	10/04→	23
ATEGO 2 1215, 1215 L, 1216, 1216 L	10/04→	21	ATEGO 2 812 K	10/04→	21
ATEGO 2 1215, 1215 L, 1216, 1216 L	10/04→	22	ATEGO 2 812, 813	10/04→	21
ATEGO 2 1216 K	10/04→	22	ATEGO 2 812, 813	10/04→	22
ATEGO 2 1218 K	10/04→	22	ATEGO 2 812, 813	10/04→	23
ATEGO 2 1218, 1218 L	10/04→	22	ATEGO 2 815 K, 816 K	10/04→	21
ATEGO 2 1222 K	10/04→	26	ATEGO 2 815 K, 816 K	10/04→	22
ATEGO 2 1222, 1222 L	10/04→	26	ATEGO 2 815 K, 816 K	10/04→	23
ATEGO 2 1223, 1223 L, 1224, 1224 L	10/04→	38	ATEGO 2 815, 815 L, 816, 816 L	10/04→	21
ATEGO 2 1223, 1223 L, 1224, 1224 L	10/04→	39	ATEGO 2 815, 815 L, 816, 816 L	10/04→	22
ATEGO 2 1224 K	10/04→	38	ATEGO 2 815, 815 L, 816, 816 L	10/04→	23
ATEGO 2 1226, 1226 L	10/04→	38	ATEGO 2 818 K	10/04→	22
ATEGO 2 1228, 1228 L, 1229, 1229 L	10/04→	38	ATEGO 2 818 K	10/04→	23
ATEGO 2 1228, 1228 L, 1229, 1229 L	10/04→	39	ATEGO 2 818, 818 L	10/04→	22
ATEGO 2 1315	01/11→	21	ATEGO 2 818, 818 L	10/04→	23
ATEGO 2 1318 A	10/04→	22	ATEGO 2 822 K	10/04→	26
ATEGO 2 1318 AK	10/04→	22	ATEGO 2 822, 822 L	10/04→	26
ATEGO 2 1318 K	10/04→	22	ATEGO 2 823, 823 L, 824, 824 L	10/04→	38
ATEGO 2 1318, 1318 L	10/04→	22	ATEGO 2 823, 823 L, 824, 824 L	10/04→	39
ATEGO 2 1322 K	10/04→	26	ATEGO 2 824 K	10/04→	38
ATEGO 2 1322 LS	10/04→	26	ATEGO 2 915, 915 L, 916, 916 L	10/04→	21
ATEGO 2 1322, 1322 L	10/04→	26	ATEGO 2 915, 915 L, 916, 916 L	10/04→	22
ATEGO 2 1323 A, 1324 A	10/04→	38	ATEGO 2 915, 915 L, 916, 916 L	10/04→	23
ATEGO 2 1323 A, 1324 A	10/04→	39	ATEGO 2 916 K	10/04→	22
ATEGO 2 1323 LS, 1324 LS	10/04→	38	ATEGO 2 916 K	10/04→	23
ATEGO 2 1323 LS, 1324 LS	10/04→	39	ATEGO 2 918 K	10/04→	23
ATEGO 2 1323, 1323 L, 1324, 1324 L	10/04→	38	ATEGO 2 918, 918 L	10/04→	23
ATEGO 2 1323, 1323 L, 1324, 1324 L	10/04→	39	ATEGO 2 922 K	10/04→	26
ATEGO 2 1324 AK	10/04→	38	ATEGO 2 922, 922 L	10/04→	26
ATEGO 2 1324 K	10/04→	38	ATEGO 2 923, 923 L, 924, 924 L	10/04→	38
ATEGO 2 1326 LS	10/04→	38	ATEGO 2 923, 923 L, 924, 924 L	10/04→	39
ATEGO 2 1326, 1326 L	10/04→	38	ATEGO 2 924 K	10/04→	38
ATEGO 2 1328 LS, 1329 LS	10/04→	38	ATEGO 712	01/98→10/04	21
ATEGO 2 1328 LS, 1329 LS	10/04→	39	ATEGO 714	01/98→10/04	21
ATEGO 2 1328, 1328 L, 1329, 1329 L	10/04→	38	ATEGO 714 K	01/98→10/04	21
ATEGO 2 1328, 1328 L, 1329, 1329 L	10/04→	39	ATEGO 715, 715 L	01/98→10/04	21
ATEGO 2 1418	01/11→	22	ATEGO 717	01/98→10/04	21
ATEGO 2 1418 K	01/11→	21	ATEGO 717 K	01/98→10/04	21
ATEGO 2 1518 A	10/04→	22	ATEGO 812	01/98→10/04	21
ATEGO 2 1518 K	10/04→	22	ATEGO 814 K	01/98→10/04	21
ATEGO 2 1518, 1518 L	10/04→	21	ATEGO 814, 814 L	01/98→10/04	21
ATEGO 2 1518, 1518 L	10/04→	22	ATEGO 815 F	01/98→10/04	21
ATEGO 2 1522 K	10/04→	26	ATEGO 815 K	01/98→10/04	21
ATEGO 2 1522, 1522 L	10/04→	26	ATEGO 815, 815 L	01/98→10/04	21
ATEGO 2 1523 A, 1524 A	10/04→	38	ATEGO 817 K	01/98→10/04	21
ATEGO 2 1523 A, 1524 A	10/04→	39	ATEGO 817, 817 L	01/98→10/04	21
ATEGO 2 1523 K, 1524 K	10/04→	38	ATEGO 823 K	01/98→10/04	39



21 9

ATEGO 823,823 L	01/98→10/04	39
ATEGO 917 AF	01/98→10/04	21
ATEGO 917 K	01/98→10/04	21
ATEGO 917,917 L	01/98→10/04	21
ATEGO 923 K	01/98→10/04	39
ATEGO 923,923 L	01/98→10/04	39
ATEGO 925 AF	01/98→10/04	39
ATEGO 1017 A	01/98→10/04	21
ATEGO 1017 AK	01/98→10/04	21
ATEGO 1017 K	01/98→10/04	21
ATEGO 1017 KO, 1018 KO	01/98→10/04	21
ATEGO 1017 KO, 1018 KO	01/98→10/04	22
ATEGO 1017,1017 L	01/98→10/04	21
ATEGO 1023,1023 L	01/98→10/04	39
ATEGO 1214, 1214 L	01/98→10/04	21
ATEGO 1215 K	01/98→10/04	21
ATEGO 1215,1215 L	01/98→10/04	21
ATEGO 1217 K	01/98→10/04	21
ATEGO 1217 KO	01/98→10/04	21
ATEGO 1217,1217 L	01/98→10/04	21
ATEGO 1223,1223 L	01/98→10/04	39
ATEGO 1225 AF	01/98→10/04	39
ATEGO 1225 F	01/98→10/04	39
ATEGO 1228,1228 L	01/98→10/04	39
ATEGO 1317 A	01/98→10/04	21
ATEGO 1317 AK	01/98→10/04	21
ATEGO 1317 K	01/98→10/04	21
ATEGO 1317 KO, 1317 LKO, 1318 KO, 1318 LKO	01/98→10/04	21
ATEGO 1317 KO, 1317 LKO, 1318 KO, 1318 LKO	01/98→10/04	22
ATEGO 1317,1317 L	01/98→10/04	21
ATEGO 1323 KO, 1323 LKO	01/98→10/04	39
ATEGO 1323 LS	01/98→10/04	39
ATEGO 1323,1323 L	01/98→10/04	39
ATEGO 1325 AF	01/98→10/04	39
ATEGO 1325 F	01/98→10/04	39
ATEGO 1328 AF	01/98→10/04	39
ATEGO 1328 F	01/98→10/04	39
ATEGO 1328 LS	01/98→10/04	39
ATEGO 1328,1328 L	01/98→10/04	39
ATEGO 1517 A	01/98→10/04	21
ATEGO 1517 K	01/98→10/04	21
ATEGO 1517,1517 L	01/98→10/04	21
ATEGO 1523 A	01/98→10/04	39
ATEGO 1523 AK	01/98→10/04	39
ATEGO 1523 K	01/98→10/04	39
ATEGO 1523 KO	01/98→10/04	39
ATEGO 1523,1523 L	01/98→10/04	39
ATEGO 1525 AF	01/98→10/04	39
ATEGO 1528 AF	01/98→10/04	39
ATEGO 1528 F	01/98→10/04	39
ATEGO 1528,1528 L	01/98→10/04	39
ATEGO 1823 AK	05/98→09/04	39
ATEGO 1823 K	05/98→09/04	39
ATEGO 1823 LS	05/98→09/04	39
ATEGO 1823,1823 L	01/98→09/04	39
ATEGO 1828 A	05/98→09/04	39
ATEGO 1828 AK	05/98→09/04	39
ATEGO 1828 K	05/98→09/04	39
ATEGO 1828 LS	05/98→09/04	39
ATEGO 1828,1828 L	05/98→09/04	39
ATEGO 2523 L	05/98→09/04	39
ATEGO 2528 L	05/98→09/04	39
ATEGO 2628	05/98→09/04	39
ATEGO 2628 B	05/98→09/04	39
ATEGO 2628 K	05/98→09/04	39
AXOR 2 1823 AK, 1824 AK	10/04→	38
AXOR 2 1823 AK, 1824 AK	10/04→	39
AXOR 2 1823 K, 1823 KL, 1824 K	10/04→	38
AXOR 2 1823 K, 1823 KL, 1824 K	10/04→	39
AXOR 2 1823 LS, 1824 LS	10/04→	38
AXOR 2 1823 LS, 1824 LS	10/04→	39
AXOR 2 1823, 1823 L, 1824, 1824 L, LL	10/04→	38
AXOR 2 1823, 1823 L, 1824, 1824 L, LL	10/04→	39



21 9

AXOR 2 1826 AK	10/04→	38
AXOR 2 1826 K	10/04→	38
AXOR 2 1826 LS	10/04→	38
AXOR 2 1826, 1826 L, LL	10/04→	38
AXOR 2 1828 A, 1829 A	10/04→	38
AXOR 2 1828 A, 1829 A	10/04→	39
AXOR 2 1828 AK, 1829 AK	10/04→	38
AXOR 2 1828 AK, 1829 AK	10/04→	39
AXOR 2 1828 K, 1828 KL, 1829 K	10/04→	38
AXOR 2 1828 K, 1828 KL, 1829 K	10/04→	39
AXOR 2 1828, 1828 L, 1829, 1829 L, LL	10/04→	38
AXOR 2 1828, 1828 L, 1829, 1829 L, LL	10/04→	39
AXOR 2 1829 LS	10/04→	38
AXOR 2 1833 A	10/04→	41
AXOR 2 1833 AK	10/04→	41
AXOR 2 1833 K	10/04→	41
AXOR 2 1833 LS	10/04→	41
AXOR 2 1833, 1833 L, LL	10/04→	41
AXOR 2 1836 LS	10/04→	61
AXOR 2 1836 LS	10/04→	76
AXOR 2 1840 LS	10/04→	61
AXOR 2 1840 LS	10/04→	76
AXOR 2 1840 LS	10/04→	79
AXOR 2 1843 LS	10/04→	61
AXOR 2 1933 S	01/11→	41
AXOR 2 2035 S	01/11→	76
AXOR 2 2040 S	01/11→	80
AXOR 2 2044 S	01/11→	82
AXOR 2 2528 L, 2529 L	10/04→	38
AXOR 2 2528 L, 2529 L	10/04→	39
AXOR 2 2533 L	10/04→	41
AXOR 2 2535 L, 2536 L	10/04→	61
AXOR 2 2535 L, 2536 L	10/04→	76
AXOR 2 2540 L	10/04→	61
AXOR 2 2540 L	10/04→	76
AXOR 2 2543 L	10/04→	61
AXOR 2 2543 L	10/04→	76
AXOR 2 2628 B, 2629 B	10/04→	38
AXOR 2 2628 B, 2629 B	10/04→	39
AXOR 2 2628 K, 2629 K	10/04→	38
AXOR 2 2628 K, 2629 K	10/04→	39
AXOR 2 2628, 2629	10/04→	38
AXOR 2 2628, 2629	10/04→	39
AXOR 2 2633	10/04→	41
AXOR 2 2633 B	10/04→	41
AXOR 2 2633 K	10/04→	41
AXOR 2 2636 B	10/04→	61
AXOR 2 2636 B	10/04→	76
AXOR 2 2636 K	10/04→	61
AXOR 2 2636 K	10/04→	76
AXOR 2 2640 B	10/04→	80
AXOR 2 2640 B	10/04→	81
AXOR 2 2640 K	10/04→	80
AXOR 2 2640 K	10/04→	81
AXOR 2 2643 B	10/04→	80
AXOR 2 2643 B	10/04→	81
AXOR 2 2643 K	10/04→	80
AXOR 2 2643 K	10/04→	81
AXOR 2 2644 S	01/11→	82
AXOR 2 2831	01/11→	41
AXOR 2 3236 B	10/04→	80
AXOR 2 3236 B	10/04→	81
AXOR 2 3236 K	10/04→	80
AXOR 2 3236 K	10/04→	81
AXOR 2 3240	03/05→	61
AXOR 2 3240	03/05→	76
AXOR 2 3240 B	10/04→	80
AXOR 2 3240 B	10/04→	81
AXOR 2 3240 K	10/04→	80
AXOR 2 3240 K	10/04→	81
AXOR 2 3243	03/05→	61
AXOR 2 3243	03/05→	76
AXOR 2 3243 B	10/04→	80



21

9



21

9

AXOR 2 3243 B	10/04→	81	LK/LN2 1120 O,1120 LO	01/84→12/98	30
AXOR 2 3243 K	10/04→	80	LK/LN2 1120 O,1120 LO	01/84→12/98	35
AXOR 2 3243 K	10/04→	81	LK/LN2 1120 S,1120 LS	01/84→12/98	30
AXOR 2 3335	10/04→	76	LK/LN2 1120 S,1120 LS	01/84→12/98	35
AXOR 2 3335 S	09/08→	76	LK/LN2 1120,1120 L	01/84→12/98	30
AXOR 2 3340	10/04→	76	LK/LN2 1120,1120 L	01/84→12/98	35
AXOR 2 3340 K	10/04→	61	LK/LN2 1124 AF	03/92→12/98	35
AXOR 2 3340 K	10/04→	76	LK/LN2 1124 AF	03/92→12/98	37
AXOR 2 3340 K	10/04→	80	LK/LN2 1124 F	03/92→12/98	35
AXOR 2 3340 K	10/04→	81	LK/LN2 1214 A	01/84→12/98	30
AXOR 2 3343	10/04→	76	LK/LN2 1217 KO	03/94→12/98	30
AXOR 2 3343 B	10/04→	80	LK/LN2 1314	07/84→12/98	30
AXOR 2 3343 B	10/04→	81	LK/LN2 1314 AK	06/87→12/98	33
AXOR 2 3344 K	01/11→	76	LK/LN2 1314 K	07/84→12/98	30
AXOR 2 4144 K	01/11→	76	LK/LN2 1314 K	07/84→12/98	33
AXOR 1823	01/02→10/04	39	LK/LN2 1314 KO	07/84→12/98	30
AXOR 1823 K	01/02→10/04	39	LK/LN2 1317 AK	08/84→12/98	33
AXOR 1835 LS	01/02→10/04	76	LK/LN2 1317 AK	12/92→12/98	33
AXOR 1840 LS	01/02→10/04	76	LK/LN2 1317 K	07/84→12/98	30
AXOR 1843 LS	01/02→10/04	76	LK/LN2 1317 K	07/84→12/98	35
AXOR 2523	01/02→10/04	39	LK/LN2 1317 K	03/96→12/98	21
AXOR 2523 K	01/02→10/04	39	LK/LN2 1317 KO	03/94→12/98	30
AXOR 2528	01/02→10/04	39	LK/LN2 1317 KO	03/94→12/98	35
AXOR 2535 LS	01/02→10/04	76	LK/LN2 1317 KO	03/96→12/98	21
AXOR 2540 LS	01/02→10/04	76	LK/LN2 1317 LS	03/96→12/98	21
AXOR 2543 LS	01/02→10/04	76	LK/LN2 1317 S,1317 LS	01/84→12/98	30
AXOR 2623 L	01/02→10/04	39	LK/LN2 1317 S,1317 LS	01/84→12/98	35
AXOR 2628 B	01/02→10/04	39	LK/LN2 1317,1317 L	01/84→12/98	30
AXOR 2628 K	01/02→10/04	39	LK/LN2 1317,1317 L	01/84→12/98	35
AXOR 2628 L	01/02→10/04	39	LK/LN2 1317,1317 L	03/96→12/98	21
AXOR 3228 C	01/02→10/04	39	LK/LN2 1320 AK	12/92→12/98	33
CITARO (O 530) Citaro	01/98→	72	LK/LN2 1320 L	12/92→12/98	35
CITARO (O 530) Citaro	01/98→	73	LK/LN2 1320 S,1320 LS	01/84→12/98	30
CITARO (O 530) Citaro	04/99→	39	LK/LN2 1320 S,1320 LS	01/84→12/98	33
CITARO (O 530) Citaro G	01/99→	39	LK/LN2 1320 S,1320 LS	01/84→12/98	35
CITARO (O 530) Citaro G	04/00→	70	LK/LN2 1320,1320 L	01/84→12/98	30
CITARO (O 530) Citaro N	01/98→	39	LK/LN2 1320,1320 L	01/84→12/98	33
CITARO (O 530) Citaro N	01/98→	73	LK/LN2 1320,1320 L	01/84→12/98	35
CITARO (O 530) Citaro N	06/00→	70	LK/LN2 1324 L	01/91→12/98	30
CITARO (O 530) Citaro NG	04/00→	70	LK/LN2 1324 S,1324 LS	01/84→12/98	35
CITO (O 520) 177 kW	06/99→	21	LK/LN2 1324,1324 L	01/84→12/98	35
CONECTO (O 345) CONECTO C, H, M, UE	11/01→	73	LK/LN2 1514 K	01/89→12/98	30
CONECTO (O 345) CONECTO C, H, UE	11/01→	39	LK/LN2 1514,1514 L	01/84→12/98	30
ECONIC 1823 LL	03/98→	39	LK/LN2 1517 K	01/89→12/98	30
ECONIC 1828 LL	03/98→	39	LK/LN2 1517 K	03/96→12/98	21
ECONIC 2628	01/98→	39	LK/LN2 1517,1517 L	01/84→12/98	30
ECONIC 2628 LL	03/98→	39	LK/LN2 1517,1517 L	01/84→12/98	35
Industrial	01/72→12/82	94	LK/LN2 1517,1517 L	03/96→12/98	21
Industrial	01/81→	94	LK/LN2 1520,1520 L	01/84→12/98	30
Industrial	01/86→	95	LK/LN2 1520,1520 L	01/84→12/98	35
Industrial	01/88→	97	LK/LN2 1524,1524 L	01/84→12/98	35
INTEGRO (O 550) Integro L	01/06→	75	LK/LN2 1724	01/84→12/98	35
INTEGRO (O 550) Integro, Integro M	01/06→	75	LK/LN2 2020 L	01/84→12/98	30
LK/LN2 1114 A	02/87→12/98	33	LK/LN2 2020 L	01/84→12/98	33
LK/LN2 1114 AK	02/87→12/98	33	LK/LN2 2024 L	01/84→12/98	35
LK/LN2 1114 K	03/84→12/98	30	LK/LN2 709	03/84→12/98	19
LK/LN2 1114 S	03/84→12/98	30	LK/LN2 709 K	03/84→10/90	19
LK/LN2 1114,1114 L	01/84→12/98	30	LK/LN2 711	03/94→12/98	19
LK/LN2 1117 A	06/87→12/98	33	LK/LN2 711	03/96→12/98	21
LK/LN2 1117 AK	04/84→12/98	30	LK/LN2 809	03/84→12/98	19
LK/LN2 1117 AK	04/84→12/98	33	LK/LN2 809 K	03/84→12/98	19
LK/LN2 1117 K	04/84→12/98	30	LK/LN2 811	03/94→12/98	19
LK/LN2 1117 K	03/96→12/98	21	LK/LN2 811	03/96→12/98	21
LK/LN2 1117 LO	03/96→12/98	21	LK/LN2 811 K	03/94→12/98	19
LK/LN2 1117 O,1117 LO	01/84→12/98	30	LK/LN2 811 K	03/96→12/98	21
LK/LN2 1117 S	03/96→12/98	21	LK/LN2 814 F	05/86→12/98	30
LK/LN2 1117 S,1117 LS	01/84→12/98	30	LK/LN2 814 F	03/94→12/98	19
LK/LN2 1117,1117 L	01/84→12/98	30	LK/LN2 814 F	03/96→12/98	21
LK/LN2 1117,1117 L	03/96→12/98	21	LK/LN2 814 K	03/84→12/98	30
LK/LN2 1120 AF	02/87→12/98	33	LK/LN2 814 K	03/94→12/98	19
LK/LN2 1120 F	02/90→12/98	33	LK/LN2 814 K	03/96→12/98	21
LK/LN2 1120 F	02/90→12/98	35	LK/LN2 814 LO	03/96→12/98	21
LK/LN2 1120 L	08/84→12/98	30	LK/LN2 814 O, 814 LO	01/84→12/98	30



21 9

LK/LN2 814 S	03/84→12/98	30
LK/LN2 814 S	03/94→12/98	19
LK/LN2 814 S	03/96→12/98	21
LK/LN2 814,814 L	01/84→12/98	19
LK/LN2 814,814L	01/84→12/98	30
LK/LN2 814,814L	03/96→12/98	21
LK/LN2 817 F	03/84→12/98	30
LK/LN2 817 F	03/96→12/98	21
LK/LN2 817 K	01/86→12/98	30
LK/LN2 817 K	03/96→12/98	21
LK/LN2 817 LO	03/96→12/98	21
LK/LN2 817 O, 817 LO	01/84→12/98	30
LK/LN2 817 S,817 LS	01/84→12/98	30
LK/LN2 817 S,817 LS	03/96→12/98	21
LK/LN2 817,817 L	01/84→12/98	30
LK/LN2 817,817 L	03/96→12/98	21
LK/LN2 914	03/84→12/98	30
LK/LN2 914 AK	02/87→12/98	30
LK/LN2 914 AK	02/87→12/98	33
LK/LN2 914 K	03/84→12/98	30
LK/LN2 914 KO	01/87→12/98	30
LK/LN2 917	03/94→12/98	30
LK/LN2 917	03/96→12/98	21
LK/LN2 917 AF	02/87→12/98	33
LK/LN2 917 AK	03/94→12/98	33
LK/LN2 917 K	03/94→12/98	30
LK/LN2 917 K	03/96→12/98	21
LK/LN2 917 KO	03/94→12/98	30
LK/LN2 917 KO	03/96→12/98	21
LK/LN2 O 1114 ,O 1114 L	01/84→12/98	30
LK/LN2 O 814, O 814 L	01/84→12/98	19
LP LP 608,LPL 608	09/63→12/84	18
LP LP 709,LPL 709	09/63→12/84	18
LP LP 808,LPL 808	09/63→12/84	18
LP LP 809, LPL 808, LPL 809	09/63→12/84	18
LP LP 811	10/69→02/73	27
LP LP 813,LPL 813	09/63→12/84	27
LP LP 911 B	01/67→03/77	27
LP LP 913,LPL 913	09/63→12/84	27
LP LP 1013	11/76→12/84	27
LP LP 1013	11/76→12/84	28
LP LP 1113	01/80→12/84	27
LP LPK 608	10/69→10/77	18
LP LPK 709	11/77→12/84	18
LP LPK 808	10/69→10/77	18
LP LPK 809	11/77→12/84	18
LP LPK 813	03/73→12/84	27
LP LPK 913	01/67→12/84	27
LP LPK 1013	11/76→12/84	27
LP LPKF 608	09/63→12/84	18
LP LPKF 709	11/77→12/84	18
LP LPKF 808, LPKF 809	10/69→10/77	18
LP LPKO 608	02/66→07/77	18
LP LPO 608	10/69→10/77	18
LP LPO 709	11/77→12/84	18
LP LPO 808, LPO 809	09/67→10/77	18
LP LPO 811	10/69→	27
LP LPS 608,LPLS 608	09/63→12/84	18
LP LPS 709,LPLS 709	09/63→12/84	18
LP LPS 811	10/69→02/73	27
LP LPS 813,LPLS 813	09/63→12/84	27
LP LPS 911 B	01/67→03/77	27
LP LPS 913	10/69→12/84	27
MB-TRAC 65/70, 700, 800	07/73→12/91	18
MB-TRAC 700, 800	02/87→12/91	19
MB-TRAC 900	09/81→12/91	18
MB-TRAC 900	03/87→12/91	19
MB-TRAC 1000	12/82→12/87	27
MB-TRAC 1000, 1100	02/87→12/91	31
MB-TRAC 1100	03/79→08/87	27
MB-TRAC 1300	03/76→08/87	28
MB-TRAC 1300, 1400	02/82→12/91	31
MB-TRAC 1500	07/80→12/87	28



21 9

MB-TRAC 1600	06/90→12/91	31
MB-TRAC 1800	06/90→12/91	31
MK 1222	07/89→08/94	52
MK 1222 A, 1222 LA	09/89→07/94	52
MK 1222 A, 1222 LA	09/89→07/94	55
MK 1222 AF	09/89→09/93	52
MK 1222 F	07/89→08/94	52
MK 1222 S, 1222 LS	07/89→08/94	52
MK 1224 AF	02/93→09/96	35
MK 1224 AF	02/93→09/96	46
MK 1224 F	07/89→08/94	35
MK 1226 AF	02/90→09/93	88
MK 1226 AF	02/93→09/96	46
MK 1226 AF	02/93→09/96	53
MK 1227 A	01/92→07/92	46
MK 1227 AF, 1227 LAF	01/92→07/92	53
MK 1231 AF	01/92→09/96	46
MK 1234 AF	01/92→09/96	53
MK 1417	07/89→09/96	30
MK 1417 A	09/89→09/96	30
MK 1417 AK	09/89→09/96	30
MK 1417 K	07/89→09/96	30
MK 1420 AK	09/89→09/96	30
MK 1420 AK	09/89→09/96	52
MK 1420 LS	02/90→09/96	30
MK 1420,1420 L	12/87→09/96	30
MK 1422	02/93→08/94	46
MK 1422 F	07/89→09/93	52
MK 1422 F	02/93→08/94	46
MK 1422 F	03/93→08/94	35
MK 1422 LS	02/93→08/94	46
MK 1422 S,1422 LS	12/87→09/96	52
MK 1422,1422 L	12/87→09/96	52
MK 1424	07/89→09/96	35
MK 1424 S,1424 LS	12/87→09/96	46
MK 1424 S,1424 LS	12/87→09/96	53
MK 1424,1424 L	12/87→09/96	46
MK 1424,1424 L	12/87→09/96	53
MK 1426 S,1426 LS	12/87→09/96	88
MK 1427	02/93→09/96	46
MK 1427 F	02/93→09/96	46
MK 1427 F	02/93→09/96	53
MK 1427 L	12/87→09/96	46
MK 1427 LS	02/93→09/96	53
MK 1427 S, 1427 LS	02/93→09/96	46
MK 1429 AF	01/92→09/96	88
MK 1431	12/87→08/96	46
MK 1431	12/87→08/96	88
MK 1431 F	12/87→08/96	46
MK 1624 S	12/87→09/96	46
MK 1624 S	12/87→09/96	53
MK 1627 AF	01/92→09/96	88
MK 1717 AK	09/89→08/94	30
MK 1717 K	09/89→08/94	30
MK 1717,1717 L	12/87→09/96	30
MK 1720 L	12/88→08/94	55
MK 1720 S	02/90→08/94	30
MK 1720,1720 L	12/87→09/96	30
MK 1722	08/88→08/94	55
MK 1722	12/88→08/94	88
MK 1722 AK	12/88→08/94	35
MK 1722 AK	12/88→08/94	46
MK 1722 AK	12/88→08/94	52
MK 1722 AK	12/88→08/94	55
MK 1722 L	12/88→08/94	30
MK 1722 S	12/88→08/94	52
MK 1722 S	12/88→08/94	55
MK 1722, 1722 L, 1722 LL	08/88→08/94	52
MK 1722,1722 L, 1722 LL	12/87→09/96	52
MK 1722,1722 L, 1722 LL	12/87→09/96	55



21

9



21

9

MK 1726 AK	06/89→08/94	88	MK 2433 S,2433 LS	12/87→09/96	53
MK 1726 K	12/88→08/94	88	MK 2433,2433 L, 2434 L	12/87→09/96	53
MK 1726 L, 1726 LL	12/88→08/94	53	MK 2522 L	12/87→09/96	52
MK 1726 LL	12/87→09/96	46	MK 2522 L	12/87→09/96	55
MK 1726 S,1726 LS	12/87→09/96	88	MK 2524	06/92→09/96	46
MK 1726,1726 L, 1726 LL	12/87→09/96	88	MK 2524	01/94→09/96	53
MK 1727 L	12/88→08/94	46	MK 2524 K	06/92→09/96	46
MK 1729	12/87→09/96	88	MK 2524 K	01/94→09/96	53
MK 1729 LS	12/87→09/96	88	MK 2524 L	12/87→09/96	46
MK 1733 S,1733 LS	12/87→09/96	53	MK 2524 L	12/87→09/96	53
MK 1733,1733 L, 1734 L	12/87→09/96	53	MK 2524,2524 L	12/87→09/96	46
MK 1820 AK	07/93→09/96	30	MK 2524,2524 L	12/87→09/96	53
MK 1820 AK	07/93→09/96	35	MK 2527	10/93→09/96	46
MK 1820 K	05/92→09/96	30	MK 2527	01/94→09/96	53
MK 1820 K	05/92→09/96	35	MK 2527 B	03/91→09/96	46
MK 1820,1820 L	12/87→09/96	30	MK 2527 B	01/94→09/96	53
MK 1820,1820 L	12/87→09/96	35	MK 2527 K	10/93→09/96	46
MK 1824	12/88→08/94	88	MK 2527 K	01/94→09/96	53
MK 1824	08/92→09/96	46	MK 2527 L	12/87→09/96	46
MK 1824	01/94→09/96	53	MK 2527 L	12/87→09/96	53
MK 1824 AK	08/92→09/96	35	MK 2527 L	03/91→08/94	88
MK 1824 AK	08/92→09/96	46	MK 2527 L	09/92→09/96	46
MK 1824 AK	01/94→09/96	53	MK 2527 L	01/94→09/96	53
MK 1824 K	08/92→09/96	46	MK 2531 B	12/87→09/96	46
MK 1824 K	01/94→09/96	53	MK 2531 L	12/87→09/96	46
MK 1824,1824 L	12/87→09/96	53	MK 2531 L	12/87→09/96	53
MK 1827 AK	08/92→09/96	46	MK 2531,2531 L	12/87→09/96	46
MK 1827 AK	08/92→09/96	53	MK 2531,2531 L	12/87→09/96	53
MK 1827 K	01/94→09/96	53	MK 2534 K	01/91→09/96	53
MK 1827 S,1827 LS	12/87→09/96	46	MK 2534 L	12/87→09/96	46
MK 1827 S,1827 LS	12/87→09/96	53	MK 2534 L	12/87→09/96	53
MK 1827,1827 L	12/87→09/96	46	MK 2534 S,2534 LS	12/87→09/96	53
MK 1827,1827 L	12/87→09/96	53	MK 2534,2534 L	12/87→09/96	53
MK 1831 K	12/88→08/94	46	MK 3231 L	12/87→09/96	46
MK 1831 K	12/88→08/94	84	MK 3231 L	12/87→09/96	53
MK 1831 S,1831 LS	12/87→09/96	46	NG 1013	02/76→12/84	27
MK 1831 S,1831 LS	12/87→09/96	53	NG 1013 A	02/76→12/86	27
MK 1831,1831 L	12/87→09/96	46	NG 1013 AK	02/76→12/84	27
MK 1831,1831 L	12/87→09/96	53	NG 1013 K	02/76→12/84	27
MK 1834 S,1834 LS	12/87→09/96	53	NG 1013 KO	02/76→12/84	27
MK 1834,1834 L	12/87→09/96	53	NG 1013 S	02/76→12/84	27
MK 1926	12/87→09/96	88	NG 1017	11/75→02/91	28
MK 2320 L	12/87→09/96	30	NG 1017 A	11/75→02/91	28
MK 2327 L	12/87→09/96	46	NG 1017 AF	11/75→09/85	28
MK 2327 L	12/87→09/96	53	NG 1017 AK	02/76→12/84	28
MK 2420,2420 L	12/87→09/96	30	NG 1017 AS	04/77→09/85	28
MK 2422	09/89→08/94	52	NG 1017 K	02/76→12/84	28
MK 2422, 2422 L	09/89→08/94	52	NG 1017 KO,1017 F	08/73→09/96	28
MK 2422 B	09/89→08/94	55	NG 1017 S,1017 LS	08/73→09/96	28
MK 2422 K	09/89→08/94	52	NG 1019 AF	01/79→12/82	45
MK 2422 K	09/89→08/94	55	NG 1019 AF	01/79→12/82	49
MK 2422 L	12/87→09/96	52	NG 1019 F	01/79→12/82	45
MK 2422 L	12/87→09/96	55	NG 1213	09/75→05/86	27
MK 2422, 2422 L	09/89→08/94	55	NG 1213 A	09/75→05/86	27
MK 2422,2422 L	12/87→09/96	52	NG 1213 AK	09/75→05/86	27
MK 2422,2422 L	12/87→09/96	55	NG 1213 AKO	09/75→05/86	27
MK 2426	12/87→09/96	88	NG 1213 AS	09/75→05/86	27
MK 2426	01/90→08/94	88	NG 1213 K	09/75→05/86	27
MK 2426 B	02/90→08/94	88	NG 1213 KO	09/75→05/86	27
MK 2426 L	12/87→09/96	88	NG 1213 S	09/75→05/86	27
MK 2426 L	02/90→08/94	46	NG 1217 A	09/75→09/85	28
MK 2426 L	02/90→08/94	53	NG 1217 AK	09/75→09/85	28
MK 2426, 2426 L	02/90→08/94	88	NG 1217 AS	09/75→09/85	28
MK 2427 B	02/90→08/94	46	NG 1217 CA	05/82→10/90	30
MK 2427 B	02/90→08/94	88	NG 1217 K	09/75→12/84	28
MK 2427 L	12/87→09/96	46	NG 1217 KO	09/75→09/85	28
MK 2429	12/87→09/96	88	NG 1217 S,1217 LS	08/73→09/96	28
MK 2431	12/87→09/96	46	NG 1217,1217 L	08/73→09/96	28
MK 2431	12/87→09/96	53	NG 1219	09/75→09/84	45
MK 2433 K	09/89→07/92	53	NG 1219 A	09/75→12/82	45
MK 2433 L	12/87→09/96	46	NG 1219 AF	09/75→09/84	45
MK 2433 L	12/87→09/96	53	NG 1219 AK	09/75→12/84	45
MK 2433 S	12/87→09/96	53	NG 1219 F	09/75→09/84	45



21 9

NG 1219 K	09/75→09/84	45
NG 1219 S	09/75→09/84	45
NG 1222	07/82→02/90	52
NG 1222 A	05/82→10/90	52
NG 1222 AF	05/82→12/91	52
NG 1222 F	05/82→12/91	52
NG 1222 S	07/82→02/90	52
NG 1225 AF	05/82→12/91	86
NG 1225 AF	05/82→12/91	88
NG 1228 AF	05/82→12/91	86
NG 1413	09/75→12/84	27
NG 1413 A	09/75→12/84	27
NG 1413 AK	09/75→12/84	27
NG 1413 AKO	09/75→12/84	27
NG 1413 K	09/75→12/84	27
NG 1413 KO	09/75→12/84	27
NG 1414	04/84→03/91	30
NG 1414 K	04/84→03/91	30
NG 1417	05/75→12/84	28
NG 1417 A	05/75→12/84	28
NG 1417 AK	05/75→12/84	28
NG 1417 AKO	05/75→12/84	28
NG 1417 C	04/84→03/91	30
NG 1417 CA	04/84→03/91	30
NG 1417 CAK	04/84→03/91	30
NG 1417 CK	04/84→03/91	30
NG 1417 K	05/75→12/84	28
NG 1417 KO	05/75→12/84	28
NG 1419 AK	05/75→12/84	45
NG 1419 AS	05/75→12/82	45
NG 1419 C,1419 CL	08/73→09/96	29
NG 1419 F	05/75→12/82	45
NG 1419 K	05/75→12/82	45
NG 1419 S,1419 LS	08/73→09/96	45
NG 1419,1419 L	08/73→09/96	45
NG 1420 LS	07/85→03/91	30
NG 1420,1420 L	08/73→09/96	30
NG 1422 F	05/82→10/90	52
NG 1422 S, 1422 LS	08/73→09/96	52
NG 1422,1422 L	08/73→09/96	52
NG 1424 F	07/75→01/87	83
NG 1424 K	07/75→01/87	83
NG 1424 S,1424 LS	08/73→09/96	83
NG 1424,1424 L	08/73→09/96	83
NG 1425 AF	08/73→09/96	86
NG 1425 S,1425 LS	08/73→09/96	86
NG 1428 F	05/82→12/91	86
NG 1428AF	08/73→09/96	86
NG 1429 AF	08/73→09/96	88
NG 1613 K	01/75→12/84	27
NG 1613 KO	01/75→12/84	27
NG 1613,1613 L	08/73→09/96	27
NG 1614	04/84→03/91	30
NG 1614 K	04/84→03/91	30
NG 1617 AK	01/75→07/85	28
NG 1617 C,1617 CL	08/73→09/96	30
NG 1617 CAK	04/84→03/91	30
NG 1617 CK	04/84→03/91	30
NG 1617 CS	04/84→03/91	30
NG 1617 K	01/75→07/85	28
NG 1617 KO	01/75→07/85	28
NG 1617 S	01/75→07/85	28
NG 1617,1617 L	08/73→09/96	28
NG 1619 AK	11/74→12/82	45
NG 1619 C,1619 CL	08/73→09/96	29
NG 1619 K	11/74→12/82	45
NG 1619 KO	11/74→01/87	45
NG 1619 S	11/74→12/84	45
NG 1619,1619 L	08/73→09/96	45
NG 1620,1620 L	08/73→09/96	30
NG 1622 AK	05/82→10/89	52
NG 1622 K	05/82→10/89	52
NG 1622 S	05/82→03/91	52



21 9

NG 1622,1622 L	08/73→09/96	52
NG 1624 K	07/75→08/82	83
NG 1624 S,1624 LS	08/73→09/96	83
NG 1624,1624 L	08/73→09/96	83
NG 1625 AK	10/80→11/89	86
NG 1625 K	05/80→11/89	86
NG 1625 S,1625 LS	08/73→09/96	86
NG 1625,1625 L	08/73→09/96	86
NG 1626 AK	08/73→12/80	83
NG 1626 AS	05/74→12/80	83
NG 1626 K	08/73→12/80	83
NG 1626 S,1626 LS	08/73→09/96	83
NG 1626,1626 L	08/73→09/96	83
NG 1628 A	01/80→05/89	86
NG 1628 S,1628 LS	08/73→09/96	86
NG 1628,1628 L	08/73→09/96	86
NG 1632 AK	08/73→08/82	90
NG 1632 AS	05/74→09/83	90
NG 1632 K	08/73→08/82	90
NG 1632 S,1632 LS	08/73→09/96	90
NG 1632,1632 L	08/73→09/96	90
NG 1633 S,1633 LS	08/73→09/96	86
NG 1633,1633 L	08/73→09/96	86
NG 1635 K	02/86→07/89	87
NG 1635 S,1635 LS	08/73→09/96	87
NG 1635,1635 L	08/73→09/96	87
NG 1636 S,1636 LS	08/73→09/96	92
NG 1636,1636 L	08/73→09/96	92
NG 1638	11/80→12/86	86
NG 1638 S,1638 LS	08/73→09/96	86
NG 1644	06/86→08/89	87
NG 1644 S,1644 LS	08/73→09/96	87
NG 1719	09/73→08/82	45
NG 1719 AK	09/73→08/82	45
NG 1719 K	09/73→08/82	45
NG 1719 S	09/73→08/82	45
NG 1919	05/74→08/82	45
NG 1919 AK	05/74→08/82	45
NG 1919 S	05/74→08/82	45
NG 1922	10/81→10/90	52
NG 1922 AK	10/81→03/91	52
NG 1922 K	10/81→03/91	52
NG 1922 S	10/81→03/91	52
NG 1926	05/74→12/80	83
NG 1926 A	05/74→12/80	83
NG 1926 AK	08/73→12/80	83
NG 1926 AS	05/74→12/80	83
NG 1926 K	08/73→12/80	83
NG 1926 S,1926 LS	08/73→09/96	83
NG 1928 A	01/80→03/91	86
NG 1928 AK	01/80→03/91	86
NG 1928 AS	01/80→03/91	86
NG 1928 K	01/80→03/91	86
NG 1928 S,1928 LS	08/73→09/96	86
NG 1928,1928 L	08/73→09/96	86
NG 1932	05/74→03/83	90
NG 1932 A	05/74→03/83	90
NG 1932 AK	08/73→09/83	90
NG 1932 AS	05/74→12/82	90
NG 1932 K	08/73→08/82	90
NG 1932 S,1932 LS	08/73→09/96	90
NG 1933	11/80→03/91	86
NG 1933 S,1933 LS	08/73→09/96	86
NG 1935	02/86→09/89	87
NG 1935 AK	09/87→03/91	87
NG 1935 AS	09/87→03/91	87
NG 1935 S,1935 LS	08/73→09/96	87
NG 1936	10/81→03/91	92
NG 1936 AK	10/81→03/91	92
NG 1936 AS	10/81→03/91	92
NG 1936 K	10/81→03/91	92
NG 1936 S,1936 LS	08/73→09/96	92



21

9



21

9

NG 1938	11/80→06/90	86	NG 2626 S	06/75→03/81	83
NG 1938 S,1938 LS	08/73→09/96	86	NG 2628	02/80→03/91	86
NG 1944	10/85→12/89	87	NG 2628 A	02/80→03/91	86
NG 1944 S,1944 LS	08/73→09/96	87	NG 2628 AS	01/90→03/91	91
NG 2025 S	08/83→03/91	86	NG 2628 AK	02/80→03/91	86
NG 2026 S	10/76→10/80	83	NG 2628 AS	02/80→03/91	86
NG 2028 A	01/80→06/89	86	NG 2628 B	02/80→08/89	86
NG 2028 A	01/80→06/89	87	NG 2628 K	02/80→03/91	86
NG 2028 LS	01/80→06/89	86	NG 2628 S	02/80→03/91	86
NG 2032 S	08/75→09/83	90	NG 2632	05/74→09/83	90
NG 2033 LS	12/81→05/87	86	NG 2632 A	05/74→09/83	90
NG 2035 S,2035 LS	08/73→09/96	87	NG 2632 AK	08/73→09/83	90
NG 2036 LS	03/84→03/91	92	NG 2632 AS	05/74→09/83	90
NG 2219	06/76→01/87	45	NG 2632 K	08/73→09/83	90
NG 2219 C,2219 CL	08/73→09/96	29	NG 2632 S	05/74→09/83	90
NG 2219 K	06/76→01/87	45	NG 2633	05/82→05/87	86
NG 2219 KO	06/76→01/87	45	NG 2633 S	05/82→05/87	86
NG 2219,2219 L	08/73→09/96	45	NG 2635	04/86→03/91	87
NG 2220,2220 L	08/73→09/96	30	NG 2635 A	09/87→03/91	87
NG 2222	05/82→03/91	52	NG 2635 AK	09/87→03/91	87
NG 2222 B	05/82→03/91	52	NG 2635 AS	09/87→03/91	87
NG 2222 K	05/82→03/91	52	NG 2635 S	04/86→03/91	87
NG 2222 L	08/73→09/96	52	NG 2636	11/81→03/91	92
NG 2222 L	08/73→09/96	55	NG 2636 A	11/81→03/91	92
NG 2222,2222 L	08/73→09/96	52	NG 2636 AK	11/81→03/91	92
NG 2224	04/76→12/82	83	NG 2636 AS	11/81→03/91	92
NG 2224 B	05/75→03/84	83	NG 2636 K	11/81→03/91	92
NG 2224 K	04/76→12/82	83	NG 2636 S	11/81→03/91	92
NG 2224 S	07/76→12/82	83	NG 2638	01/81→12/86	86
NG 2225	04/85→03/91	86	NG 2638 S	01/81→12/86	86
NG 2225 B	08/83→03/91	86	NG 2644	08/73→09/96	87
NG 2225 L	08/73→09/96	86	NG 2644 S	10/85→02/90	87
NG 2226	09/75→12/80	83	NG 3025 B	08/83→03/91	86
NG 2226 S,2226 LS	08/73→09/96	83	NG 3025 K	12/85→07/87	86
NG 2226,2226 L	08/73→09/96	83	NG 3025 K	04/85→03/91	86
NG 2228	12/79→03/91	86	NG 3025 K	12/85→07/87	86
NG 2228 S	12/79→03/91	86	NG 3028	02/80→03/91	86
NG 2228,2228 L	08/73→09/96	86	NG 3028 B	12/85→07/87	86
NG 2232	05/74→09/83	90	NG 3028 K	12/85→07/87	86
NG 2232 S,2232 LS	08/73→09/96	90	NG 3033	05/82→05/87	86
NG 2232,2232 L	08/73→09/96	90	NG 3036	11/81→03/91	92
NG 2233	11/80→05/87	86	NG 3038	01/81→12/86	86
NG 2233 S	11/80→05/87	86	NG 3228 B	07/87→03/91	86
NG 2233,2233 L	08/73→09/96	86	NG 3228 K	07/87→03/91	86
NG 2235 K	03/86→07/89	87	NG 3235	07/88→08/94	87
NG 2235 S, 2235 LS	08/73→09/96	87	NG 3250 A	09/85→08/94	92
NG 2235,2235 L	08/73→09/96	87	NG 3250 AF	09/85→08/94	92
NG 2236	09/82→03/91	92	NG 3328	02/80→03/91	86
NG 2236 S	12/84→03/91	92	NG 3328 B	02/80→03/91	86
NG 2238 S	01/81→12/86	86	NG 3328 B	07/82→07/87	86
NG 2238,2238 L	08/73→09/96	86	NG 3328 K	07/82→07/87	86
NG 2244 S	10/85→07/89	87	NG 3333	12/82→11/91	86
NG 2244,2244 L	08/73→09/96	87	NG 3333 B	12/82→11/91	86
NG 2422	08/73→09/96	52	NG 3333 K	12/82→11/91	86
NG 2422	08/73→09/96	55	NG 3335	04/86→03/91	87
NG 2422	10/81→10/90	52	NG 3335 A	04/86→03/91	87
NG 2422 K	10/81→03/91	52	NG 3336	12/82→11/91	92
NG 2428	08/73→09/96	86	NG 3336 A	11/81→03/91	87
NG 2433	10/80→09/96	86	NG 3336 A	11/81→03/91	92
NG 2438	08/73→09/96	86	NG 3336 AK	09/86→11/91	92
NG 2438 L	11/80→06/90	86	NG 3336 K	12/82→11/91	92
NG 2444 LS	08/73→09/96	87	NG 3336 S	12/82→11/91	92
NG 2528 A	01/80→03/91	86	NG 3338	01/81→12/86	87
NG 2528 AK	01/80→03/91	86	NG 3528	07/82→07/87	86
NG 2536 AK	10/81→03/91	87	NG 3528 B	07/87→09/89	86
NG 2536 AK	10/81→03/91	92	NG 3528 K	07/82→09/89	86
NG 2626	06/75→03/81	83	NG 3535 AK	09/87→02/90	87
NG 2626 A	06/75→03/81	83	NG 3535 K	09/87→01/89	87
NG 2626 AB	05/74→12/80	83	NG 3544	08/73→09/96	87
NG 2626 AK	08/73→12/81	83	NG 3544 S	08/73→09/96	87
NG 2626 AS	06/75→03/81	83	NG 3836 AK	11/81→03/91	92
NG 2626 B	05/74→12/80	83	NG 3850 A	09/85→08/94	92
NG 2626 K	08/73→03/81	83	O 100 City	01/94→	11



21 9

O 301 O 301	02/86→05/87	30
O 301 O 301	06/86→05/87	30
O 302 130PS	11/64→11/75	27
O 302 O 302	05/69→12/74	43
O 303 O 303	10/74→06/83	45
O 303 O 303	03/75→06/83	83
O 303 O 303	07/75→06/83	90
O 303 O 303	01/80→09/87	86
O 303 O 303	01/80→09/92	52
O 303 O 303	08/80→09/87	86
O 303 O 303	11/85→04/89	52
O 303 O 303	09/87→09/92	87
O 303 O 303	09/87→09/92	88
O 303 O 303	12/87→09/92	53
O 305 O 305 G	02/78→05/87	56
O 305 O 305 G	02/79→05/87	56
O 305 O 305 ST	01/69→05/73	43
O 305 O 305 ST	04/73→07/77	54
O 305 O 305 ST	11/76→05/87	56
O 305 O 305 ST	02/79→05/87	56
O 307 O 307	04/73→07/77	54
O 307 O 307	04/73→07/77	56
O 307 O 307	11/76→07/87	56
O 307 O 307	11/76→08/87	56
O 309 O 309 D	01/70→02/89	18
O 309 O 309 D	05/77→02/89	27
O 317 O 317	01/66→01/76	50
O 317 O 317	01/66→01/76	51
O 340 O 340	01/91→06/95	53
O 340 Turismo	08/92→08/95	84
O 402 O 402	02/86→12/91	30
O 403 O 403 SHD	09/03→	74
O 404 O 404	09/91→01/92	55
O 404 O 404	09/91→01/92	88
O 404 O 404	09/91→10/99	46
O 404 O 404	09/91→10/99	53
O 404 O 404	09/91→10/99	84
O 404 O 404	09/94→10/99	53
O 404 O 404	09/94→10/99	87
O 405 O 405 G, O 405 GN, O 405 GTD	11/85→	67
O 405 O 405 G, O 405 GN, O 405 GTD	11/85→	68
O 405 O 405 G, O 405 GN, O 405 GTD	11/85→	69
O 405 O 405 G, O 405 GN, O 405 GTD	11/85→	71
O 405 O 405 G, O 405 GN, O 405 GTD	09/91→	68
O 405 O 405 G, O 405 GN, O 405 GTD	09/91→	69
O 405 O 405 G, O 405 GN, O 405 GTD	09/91→	71
O 405 O 405 G, O 405 GTD	01/86→	67
O 405 O 405 G, O 405 GTD	01/86→	68
O 405 O 405 ST	11/85→	67
O 405 O 405 ST	11/85→	68
O 405 O 405 ST, O 405 N	12/84→	67
O 405 O 405 ST, O 405 N	12/84→	68
O 405 O 405 ST, O 405 N	12/84→	69
O 405 O 405 ST, O 405 N	11/85→	67
O 405 O 405 ST, O 405 N	11/85→	68
O 405 O 405 ST, O 405 N	11/85→	69
O 405 O 405 ST, O 405 N	11/85→	71
O 405 O 405 ST, O 405 N	11/91→	68
O 405 O 405 ST, O 405 N	11/91→	69
O 405 O 405 ST, O 405 N	11/91→	71
O 407 O 407	03/87→11/01	68
O 407 O 407	11/91→11/01	68
O 408 O 408	01/91→12/98	68
O 408 O 408	08/92→12/98	68
SK 1728, 1729, 1729 L	07/87→09/96	88
SK 1729 AK	07/88→09/93	88
SK 1729 K	07/88→08/94	88
SK 1729 S, 1729 LS	07/87→09/96	88
SK 1735 AK	08/89→08/94	87
SK 1735 K	07/88→08/94	87
SK 1735 L	07/88→08/94	88
SK 1735 S, 1735 LS	07/87→09/96	87
SK 1735, 1735 L	07/87→09/96	87



21 9

SK 1748 S, 1748 LS	07/87→09/96	87
SK 1748, 1748 L	07/87→09/96	87
SK 1831 AK	05/91→09/96	46
SK 1831 AK	01/94→09/96	53
SK 1831 K	07/92→09/96	46
SK 1831 K	07/92→09/96	53
SK 1831 S, 1831 LS	07/87→09/96	46
SK 1831 S, 1831 LS	07/87→09/96	53
SK 1831, 1831 L	07/87→09/96	46
SK 1831, 1831 L	07/87→09/96	53
SK 1834 AK	07/88→09/93	53
SK 1834 S, 1834 LS	07/87→09/96	53
SK 1834, 1834 L	07/87→09/96	53
SK 1838 AK	12/92→09/96	84
SK 1838 AK	12/92→09/96	87
SK 1838 AK	01/94→09/96	87
SK 1838 K	12/90→09/96	84
SK 1838 K	06/95→09/96	87
SK 1838 S, 1838 LS	07/87→09/96	84
SK 1838 S, 1838 LS	07/87→09/96	87
SK 1838, 1838 L	07/87→09/96	84
SK 1838, 1838 L	07/87→09/96	87
SK 1840 LS	07/91→07/92	84
SK 1844 S, 1844 LS	07/87→09/96	87
SK 1844, 1844 L	07/87→09/96	87
SK 1850 K	07/88→08/94	87
SK 1850 LAS	07/87→09/96	87
SK 1850 S, 1850 LS	07/87→09/96	87
SK 1850, 1850 L	07/87→09/96	87
SK 1853 AK	01/96→09/96	87
SK 1853 S, 1853 LS	07/87→09/96	87
SK 1853, 1853 L	07/87→09/96	87
SK 1922	05/89→08/94	52
SK 1922	05/89→08/94	55
SK 1922 AK	08/89→08/94	52
SK 1922 AK	08/89→08/94	55
SK 1922 K	05/89→08/94	52
SK 1922 K	05/89→08/94	55
SK 1922 S	05/89→08/94	52
SK 1922 S	05/89→08/94	55
SK 1929 A	07/88→08/94	88
SK 1929 A	07/88→08/94	91
SK 1929 AK	07/88→08/94	88
SK 1929 AS	07/88→08/94	88
SK 1929 K	07/88→08/94	88
SK 1929 S	07/88→08/94	88
SK 1929, 1929 L	07/87→09/96	88
SK 1935	05/89→08/94	87
SK 1935 AK	05/89→08/94	87
SK 1935 AS	05/89→08/94	87
SK 1935 K	05/89→08/94	87
SK 1935 S	05/89→08/94	87
SK 1945 AK	07/88→08/94	91
SK 1948	09/88→07/92	87
SK 2024	02/93→09/96	46
SK 2024	01/94→09/96	53
SK 2024 AK	02/93→09/96	46
SK 2024 AK	01/94→09/96	53
SK 2024 K	02/93→09/96	46
SK 2024 K	01/94→09/96	53
SK 2027 AK	02/93→09/96	46
SK 2027 AK	02/93→09/96	53
SK 2031	03/92→09/96	46
SK 2031 A	03/92→09/96	46
SK 2031 A	03/92→09/96	84
SK 2031 A	03/92→09/96	87
SK 2031 A	01/94→09/96	53
SK 2031 A	01/94→09/96	87
SK 2031 AS	03/92→09/96	46
SK 2031 K	03/92→09/96	46
SK 2031 K	03/92→09/96	53
SK 2031 S	03/92→09/96	46
SK 2038	11/91→09/96	84



21

9



21

9

SK 2038	12/92→	87	SK 2629 K	07/88→08/94	88
SK 2038 AS	12/92→09/96	84	SK 2629 S	07/88→08/94	88
SK 2038 AS	12/92→09/96	87	SK 2631	06/92→09/96	46
SK 2038 AS	01/94→09/96	87	SK 2631	06/92→09/96	53
SK 2038 S	11/91→09/96	84	SK 2631 A	06/92→09/96	46
SK 2044	01/92→09/96	87	SK 2631 A	01/94→09/96	53
SK 2044 AS	01/94→09/96	87	SK 2631 AK, 2634 AK	06/92→09/96	46
SK 2044 S	01/92→09/96	87	SK 2631 AK, 2634 AK	01/94→09/96	53
SK 2050	01/91→09/96	87	SK 2631 AS	06/92→09/96	46
SK 2050 S	01/91→09/96	87	SK 2631 B	06/92→09/96	46
SK 2055 AF	01/92→09/96	87	SK 2631 K	07/88→08/94	46
SK 2422 L	07/87→09/96	52	SK 2631 K	07/88→08/94	53
SK 2429	07/87→09/96	86	SK 2631 S	06/92→09/96	46
SK 2429	07/88→08/94	88	SK 2631 S	06/92→09/96	53
SK 2429 K	07/88→08/94	88	SK 2634	06/92→09/96	53
SK 2429 S	07/88→08/94	88	SK 2634 S	06/92→09/96	53
SK 2429 S, 2429 LS	07/87→09/96	88	SK 2635	07/88→08/94	87
SK 2429, 2429 L	07/87→09/96	88	SK 2635	07/88→08/94	88
SK 2429, 2429 L	07/87→09/96	88	SK 2635	01/91→08/94	87
SK 2434 L	07/87→09/96	53	SK 2635 A	02/90→08/94	87
SK 2435	07/87→09/96	87	SK 2635 A	12/91→08/94	87
SK 2435	07/88→08/94	87	SK 2635 AK	02/90→08/94	87
SK 2435 K	07/88→08/94	87	SK 2635 AS	02/90→09/96	87
SK 2435 LS	07/87→09/96	87	SK 2635 AS	02/92→08/94	87
SK 2435 S	07/88→08/94	87	SK 2635 K	07/88→08/94	87
SK 2435 S, 2435 LS	07/87→09/96	87	SK 2635 K	01/91→08/94	84
SK 2435, 2435 L	07/87→09/96	87	SK 2635 K	07/91→08/94	87
SK 2448	07/88→07/92	87	SK 2635 S	07/88→08/94	87
SK 2448 LS	07/88→07/92	87	SK 2638 A	09/91→09/96	84
SK 2448 S	07/88→07/92	87	SK 2638 A	09/91→09/96	87
SK 2448, 2448 L	07/87→09/96	87	SK 2638 AK	09/91→09/96	87
SK 2531	05/91→09/96	46	SK 2638 AK	07/92→09/96	84
SK 2531	05/91→09/96	53	SK 2638 AK	07/92→09/96	87
SK 2531, 2531 L	07/87→09/96	46	SK 2638 AK	01/94→09/96	87
SK 2531, 2531 L	07/87→09/96	53	SK 2638 AS	07/92→09/96	84
SK 2534, 2534 L	07/87→09/96	53	SK 2638 AS	07/92→09/96	87
SK 2538	03/91→09/96	84	SK 2638 AS	01/94→09/96	87
SK 2538	03/91→09/96	87	SK 2638 K	09/91→09/96	84
SK 2538	01/94→09/96	87	SK 2638 K	09/91→09/96	87
SK 2538 K, 2538 LK	03/91→09/96	84	SK 2638 S	09/91→09/96	87
SK 2538 K, 2538 LK	03/91→09/96	87	SK 2638, 2638 L	09/91→09/96	84
SK 2538 K, 2538 LK	01/94→09/96	87	SK 2638, 2638 L	09/91→09/96	87
SK 2538 S	03/91→09/96	87	SK 2644 A	01/92→09/96	87
SK 2538 S, 2538 LS	07/87→09/96	84	SK 2644 S	01/92→09/96	87
SK 2538 S, 2538 LS	07/87→09/96	87	SK 2644, 2644 L	01/92→09/96	87
SK 2538, 2538 L	07/87→09/96	84	SK 2645 AS	02/90→09/96	87
SK 2538, 2538 L	07/87→09/96	87	SK 2648 AK	02/90→08/94	87
SK 2544	01/94→09/96	87	SK 2648 AS	07/88→08/94	87
SK 2544 LS	01/92→09/96	87	SK 2648 S	12/88→07/92	87
SK 2544 S	07/88→09/96	87	SK 2650	09/95→09/96	87
SK 2544 S	01/92→09/96	87	SK 2650 A	07/87→09/96	87
SK 2544, 2544 L	01/92→09/96	87	SK 2650 AK	07/88→08/94	87
SK 2544, 2544 L	07/87→09/96	87	SK 2650 AS	01/94→09/96	87
SK 2550	07/87→09/96	87	SK 2650 K	07/88→08/94	87
SK 2550	01/91→09/96	87	SK 2650 S	07/92→09/96	87
SK 2550 K	07/87→09/96	87	SK 2650, 2650 L	07/92→09/96	87
SK 2550 S, 2550 LS	01/91→09/96	87	SK 2653 AK	07/92→09/96	87
SK 2550, 2550 L	07/87→09/96	87	SK 3053 S	12/93→09/96	87
SK 2553 S, 2553 LS	01/96→09/96	87	SK 3053 S	01/94→09/96	87
SK 2553, 2553 L	07/87→09/96	87	SK 3229	09/89→08/94	88
SK 2629	07/88→08/94	87	SK 3229 B	09/89→07/92	88
SK 2629	07/88→08/94	88	SK 3229 K	09/89→01/92	88
SK 2629 A	07/88→08/94	84	SK 3233 B	10/90→07/92	53
SK 2629 A	07/88→08/94	87	SK 3233 K	10/90→07/92	53
SK 2629 A	07/88→08/94	88	SK 3234 B	02/92→09/96	53
SK 2629 A	07/88→08/94	91	SK 3234 K	02/92→09/96	53
SK 2629 AK	07/88→08/94	87	SK 3235	07/88→08/94	87
SK 2629 AK	07/88→08/94	88	SK 3235	10/88→07/92	87
SK 2629 AS	07/88→08/94	87	SK 3235 K	07/87→07/92	87
SK 2629 AS	07/88→08/94	88	SK 3235 L	07/87→09/96	87
SK 2629 B	07/88→08/94	88	SK 3236 A	07/87→09/96	92
SK 2629 K	07/88→08/94	46	SK 3238	10/90→09/96	84
SK 2629 K	07/88→08/94	87	SK 3238	10/90→09/96	87



21

9

SK 3238	03/91→09/96	84
SK 3238	03/91→09/96	87
SK 3238	03/91→09/96	92
SK 3238 L	07/87→09/96	84
SK 3238 L	07/87→09/96	87
SK 3238, 3238 L	10/90→09/96	87
SK 3238, 3238 L	01/94→09/96	87
SK 3244	01/94→09/96	87
SK 3244 L	07/87→09/96	87
SK 3248	07/87→09/96	87
SK 3250 L	07/87→09/96	87
SK 3253, 3253 L	01/96→09/96	87
SK 3255	07/87→09/96	87
SK 3529	07/88→08/94	88
SK 3534 K	10/93→09/96	53
SK 3535	07/88→08/94	87
SK 3535 AK	02/90→08/94	87
SK 3535 AK	03/91→08/94	84
SK 3535 B	10/88→08/94	87
SK 3535 K	07/87→09/96	87
SK 3535 K	10/88→08/94	87
SK 3535 K	03/91→08/94	84
SK 3535 S	07/88→08/94	87
SK 3538	03/91→09/96	84
SK 3538	03/91→09/96	87
SK 3538	09/91→09/96	84
SK 3538	09/91→09/96	87
SK 3538 AK	03/91→09/96	84
SK 3538 AK	03/91→09/96	87
SK 3538 AK	01/94→09/96	87
SK 3538 K	03/91→09/96	84
SK 3538 K	03/91→09/96	87
SK 3538 K	01/94→09/96	87
SK 3544	01/92→09/96	87
SK 3544 AK	03/91→09/96	87
SK 3544 K	03/91→09/96	87
SK 3548	05/92→09/96	87
SK 3550 K	03/91→09/96	87
SK 3550 S	05/92→09/96	87
SK 3550 S, 3553 S	05/92→09/96	87
SK 3553 S	04/92→	87
SK 3553, 3553 L	01/94→09/96	87
SK 4050 A	07/87→	87
SK 4080 A	07/87→	92
SK 4844	12/91→08/94	87
SK 4844 K	03/91→09/96	87
SK 4850 A	07/87→	92
T1/TN 407 D	07/81→01/89	7
T1/TN 408 D	11/88→06/95	3
T1/TN 409 D	04/82→01/89	16
T1/TN 410 D	11/88→06/95	11
T2/L L 408 DG	01/70→12/74	18
T2/L L 508 DG	01/70→12/88	18
T2/L L 608 D	01/70→12/88	18
T2/L L 608 D	02/84→12/88	18
T2/L L 613 D	04/77→12/88	27
T2/L L 911	01/72→07/83	27
T2/L LK 911	01/72→07/83	27
T2/L LKO 508 DG	06/72→06/88	18
T2/L LKO 508 DG	09/72→06/88	18
T2/L LS 911	01/72→07/83	27
T2/LN1 609 D	04/86→12/94	19
T2/LN1 609 D	06/94→12/94	19
T2/LN1 609 DK	04/86→12/94	19
T2/LN1 611 D	06/94→12/94	19
T2/LN1 611 DK	06/94→12/94	19
T2/LN1 709 D	04/86→12/94	19
T2/LN1 709 DK	04/86→12/94	19
T2/LN1 711 D	04/86→12/94	19
T2/LN1 714 D	06/94→12/94	19
T2/LN1 809 D	04/86→12/94	19
T2/LN1 809 DK	04/86→12/94	19
T2/LN1 809 DT	04/86→12/94	19



21

9

T2/LN1 811 D	04/86→12/94	19
T2/LN1 811 DK	04/86→12/94	19
T2/LN1 814 D	11/87→12/94	19
T2/LN1 814 DA	11/87→12/94	19
T2/LN1 O 609 D	07/87→12/92	19
T2/LN1 O 611 D	07/87→12/92	19
T2/LN1 O 614 D	07/87→12/92	19
TOURINO (O 510) TOURINO	10/03→	39
TOURISMO (O 350) Torismo	08/95→	53
TOURISMO (O 350) Torismo	08/95→	84
TOURISMO (O 350) Tourismo	08/95→	87
TOURISMO (O 350) Tourismo RHD, SHD	09/03→	74
TOURO (O 500) Touro	10/01→	74
TRAVEGO (O 580) 15 RH/RHD	10/99→	66
TRAVEGO (O 580) 15 RH/RHD	10/99→	72
TRAVEGO (O 580) O 580/15 RH	10/99→	66
TRAVEGO (O 580) O 580-17 RHD	10/99→	74
TRAVEGO (O 580) O 580-17 RHD	10/99→	89
UNIMOG U 52, U 60, U 600, U 600L	01/77→05/88	8
UNIMOG U 54	04/66→03/72	18
UNIMOG U 60T, U 600T	01/77→05/88	8
UNIMOG U 65 T, U 70 T	01/62→01/88	27
UNIMOG U 65, U 70	01/62→01/88	24
UNIMOG U 65, U 70	01/62→01/88	27
UNIMOG U 66, U 72	03/69→01/88	18
UNIMOG U 72, U 80	01/69→01/77	18
UNIMOG U 80 T, U 90 T	05/66→	27
UNIMOG U 80, U 84, U 90	05/69→01/88	27
UNIMOG U 90	11/92→	11
UNIMOG U 90	07/96→	15
UNIMOG U 100, U 110, U 1100L	01/77→05/88	27
UNIMOG U 100, U 110T, U 1100T	01/77→	27
UNIMOG U 100L	11/92→	11
UNIMOG U 100L	07/96→	15
UNIMOG U 110, U 110L	02/92→	19
UNIMOG U 125, U 1100L	01/77→01/88	27
UNIMOG U 130, U 140	07/92→	19
UNIMOG U 140L	07/92→	19
UNIMOG U 140T	07/92→	19
UNIMOG U 300	03/00→	21
UNIMOG U 400	03/00→	21
UNIMOG U 400	03/00→	39
UNIMOG U 500, UGN NA	10/00→	39
UNIMOG U 600	05/88→	6
UNIMOG U 650, U 650L	05/88→	6
UNIMOG U 800	01/77→03/90	18
UNIMOG U 800L	01/77→03/90	18
UNIMOG U 900	01/77→01/88	27
UNIMOG U 900	01/77→	27
UNIMOG U 900	11/88→	31
UNIMOG U 900	11/88→	32
UNIMOG U 1000	01/77→05/88	27
UNIMOG U 1000	01/88→	31
UNIMOG U 1000	01/88→	32
UNIMOG U 1000T	01/77→12/82	27
UNIMOG U 1150, U 1150L	05/88→	27
UNIMOG U 1150L	05/88→	27
UNIMOG U 1200	02/82→05/88	28
UNIMOG U 1200	01/88→	31
UNIMOG U 1200	01/88→	32
UNIMOG U 1200T	01/83→05/88	28
UNIMOG U 1200T	01/88→	31
UNIMOG U 1200T	01/88→	32
UNIMOG U 1250	12/84→05/88	28
UNIMOG U 1250, U 1250L	01/88→	31
UNIMOG U 1250, U 1250L	01/88→	32
UNIMOG U 1250L	05/88→	31
UNIMOG U 1300	01/77→12/84	28
UNIMOG U 1300, U 1300L	01/77→05/88	27
UNIMOG U 1300, U 1300L	01/77→05/88	28
UNIMOG U 1300, U 1300L	01/77→05/88	34
UNIMOG U 1350L	05/88→	31
UNIMOG U 1400	01/88→	31



21

9



21

9

UNIMOG U 1400	01/88→	32
UNIMOG U 1450, U 1450L	01/88→	31
UNIMOG U 1450, U 1450L	01/88→	32
UNIMOG U 1500	01/77→05/88	28
UNIMOG U 1500T	01/77→05/88	28
UNIMOG U 1550	01/86→05/88	28
UNIMOG U 1550 L	02/86→05/88	27
UNIMOG U 1550 L	02/86→05/88	28
UNIMOG U 1550L	05/88→	31
UNIMOG U 1550L	05/88→	32
UNIMOG U 1550L	05/88→	35
UNIMOG U 1550L	05/88→	36
UNIMOG U 1550L	01/92→	31
UNIMOG U 1550L	01/92→	32
UNIMOG U 1600	01/88→	31
UNIMOG U 1600	01/88→	32
UNIMOG U 1600	09/89→	31
UNIMOG U 1600	09/89→	32
UNIMOG U 1600	09/89→	36
UNIMOG U 1600	05/91→	35
UNIMOG U 1600	05/91→	36
UNIMOG U 1650, U 1650L	01/88→	31
UNIMOG U 1650, U 1650L	01/88→	32
UNIMOG U 1650, U 1650L	09/89→	31
UNIMOG U 1650, U 1650L	09/89→	32
UNIMOG U 1650, U 1650L	09/89→	36
UNIMOG U 1650, U 1650L	05/91→	35
UNIMOG U 1650, U 1650L	05/91→	36
UNIMOG U 1700	09/88→	31
UNIMOG U 1700	09/88→	32
UNIMOG U 1700	09/88→	34
UNIMOG U 1700, U 1700L	05/78→09/88	28
UNIMOG U 1700L	05/78→09/88	28
UNIMOG U 1700T	09/88→	31
UNIMOG U 1700T	09/88→	32
UNIMOG U 1750, U 1750L	09/88→	31
UNIMOG U 1750, U 1750L	09/88→	32
UNIMOG U 1800	04/92→	32
UNIMOG U 1800T	04/92→	32
UNIMOG U 1850, U 1850L	04/92→	32
UNIMOG U 2100	09/89→	31
UNIMOG U 2100	09/89→	32
UNIMOG U 2100T	09/89→	31
UNIMOG U 2100T	09/89→	32
UNIMOG U 2150	09/89→	31
UNIMOG U 2150	09/89→	32
UNIMOG U 2150, U 2150L	09/89→	31
UNIMOG U 2150, U 2150L	09/89→	32
UNIMOG U 2150, U 2150L	09/89→	35
UNIMOG U 2150, U 2150L	09/89→	36
UNIMOG U 2400	05/91→	35
UNIMOG U 2400	05/91→	36
UNIMOG U 2400TG	07/93→	35
UNIMOG U 2400TG	07/93→	36
UNIMOG U 2450, U 2450L	05/91→	35
UNIMOG U 2450, U 2450L	05/91→	36
UNIMOG U 2450L	07/93→	35
UNIMOG U 2450L	07/93→	36
UNIMOG U 3000	09/02→	21
UNIMOG U 3000	09/02→	23
UNIMOG U 4000	09/02→	21
UNIMOG U 4000	09/02→	23
UNIMOG U 4000	09/02→	25
UNIMOG U 5000	09/02→	25
UNIMOG U 5000	11/02→	39
UNIMOG U300	03/00→	21
UNIMOG UX 100H, UX 100M	09/96→	15
VARIO 512 D	09/96→	14
VARIO 612 D	09/96→	14
VARIO 613 D, 614 D	09/96→	21
VARIO 615 D, 616 D	09/98→	21
VARIO 618 D	09/06→	21
VARIO 810 DT	09/96→	21

VARIO 812 D	09/96→	14
VARIO 812 DT	09/96→	21
VARIO 813 D, 814 D	09/96→	21
VARIO 813 DA, 814 DA	09/96→	21
VARIO 815 D, 816 D	09/96→	21
VARIO 815 DA, 816 DA	09/96→	21
VARIO 818 D	09/06→	21
VARIO 818 DA	09/06→	21
VARIO O 810	09/96→	21
VARIO O 812	09/96→	14
VARIO O 814	09/96→	21
VARIO O 815	09/96→	21
ZETROS 1833 A	09/08→	41
ZETROS 2733 A	09/08→	41

MERCEDES-BENZ



cc



kW/PS

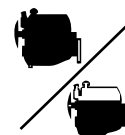

1	OM 615.913 OM 615.940	1988 1988	4 4	87.00 87.00		40/54 40/44/ 55/60	BG990 (Fibre)		
2	OM 615.912/OM 615.917 OM 615.937/OM 615.939 OM 615.941	2197 2197 2197	4 4 4	87.00 87.00 87.00	OM 615	44/60 44/60 44-49/ 60-67	BG990 (Fibre)		
3	OM 601.940	2299	4	89.00	OM 601	58-60/ 79-82	BW370 (Fibre)	DW370 ■☒○ DW372 ■[22] DW373 ■[23]	EM720
4	OM 601.942/OM 601.943	2299	4	89.00	OM 601	58/79	BW370 (Fibre)	DW370 ■☒○ DW372 ■[22] DW373 ■[23]	EM720
5	OM 601A.970	2299	4	89.00	OM 601 LA/Turbo Intercooled	72/98			EM720
6	OM 616.942 OM 616.943	2399 2399	4 4	90.90 90.90	OM 616 OM 616	38/52 44/60	BC790 (Fibre)	DC790 ■	
7	OM 616.934 OM 616.936 OM 616.937/OM 616.939	2399 2399 2399	4 4 4	90.90 90.90 90.90	OM 616 OM 616 OM 616	48/65 53/72 53/72	BC790 (Fibre)	DC790 ■	EC790 GC790
8	OM 616.932/OM 616.933	2404	4	91.00	OM 616	44/60	BC790 (Fibre)	DC790 ■	
9	OM 616.912 OM 616.916 OM 616.917	2404 2404 2404	4 4 4	91.00 91.00 91.00	OM 616	46/53/ 63/72 48/65 48/65	BC790 (Fibre)	DC790 ■	EC790 GC790
10	OM 602.938	2497	5	87.00		68/92	BN720 (Fibre), 1.74mm	DN722 ■[23]	EN720
11	OM 602.941 OM 602.991 OM 602.940 OM 602.948	2874 2874 2874 2874	5 5 5 5	89.00 89.00 89.00 89.00	OM 602 OM 602 OM 602 OM 602	65-70/ 88-95 70/95 70-72/ 95/98 71/96	BW380 (Fibre), 1.80mm	DW380 ☒○	EN720
12	OM 602.942	2874	5	89.00		70-72/ 95-98	BW380 (Fibre), 1.80mm	DW380 ☒○	EN720
13	OM 602.994	2874	5	89.00	OM 602	72/98	BW380 (Fibre), 1.80mm	DW380 ☒○	EN720
14	OM 602.980 OM 602.983 OM 602.984/OM 602.985 OM 602.982	2874 2874 2874 2874	5 5 5 5	89.00 89.00 89.00 89.00	OM 602 DE 291A/ Turbo Intercooled Turbo Intercooled OM 602 LA/Turbo Intercooled Turbo Intercooled	75-90/ 102-122 88/120 90/122 95/129	BW380 (Fibre), 1.80mm	DW381 ■☒○	

JB162	JM848	JH683		NB975 45x74.5x12mm, FPM PA815 (x1) 78x94x8mm	HBS045 [8] ⊕ M12x1.75x105mm (x4) M12x1.75x145mm (x6) M12x1.75x120mm (x8)		
JB162	JM848	JH683		NB975 45x74.5x12mm, FPM PA815 (x1) 78x94x8mm	HBS045 [8] ⊕ M12x1.75x105mm (x4) M12x1.75x145mm (x6) M12x1.75x120mm (x8)		
JD158 ■ JD159 ■	JN572 [22] JN619 [23]	JH5082 (Steel) JJ498	HR757 ■	NA5131 45x67x8mm, PTFE NB974 93x114x13mm, FPM	HBS058 [8] ⊕ M10x1.50x80mm (x4) M10x1.50x115mm (x5) M10x1.50x102mm (x9)		
JD158 ■ JD159 ■	JN572 [22] JN619 [23]	JH5082 (Steel) JJ498	HR757 ■	NB973 45x67x8mm, FPM NA5131 45x67x8mm, PTFE NB974 93x114x13mm, FPM NA5074 [24] 93x133.5x15.5mm, PTFE	HBS058 [8] ⊕ M10x1.50x80mm (x4) M10x1.50x115mm (x5) M10x1.50x102mm (x9)		
JD158 ■ JD159 ■	JN572	JH5082 (Steel) JJ498	HR757 ■	NB973 45x67x8mm, FPM NA5131 45x67x8mm, PTFE NB974 93x114x13mm, FPM NA5074 [24] 93x133.5x15.5mm, PTFE	HBS058 [8] ⊕ M10x1.50x80mm (x4) M10x1.50x115mm (x5) M10x1.50x102mm (x9)		
JB162	JM848			NB975 45x74.5x12mm, FPM PA815 (x1) 78x94x8mm			
JB162	JM848	JH683		NB975 45x74.5x12mm, FPM PA815 (x1) 78x94x8mm	HBS045 [8] ⊕ M12x1.75x105mm (x4) M12x1.75x145mm (x6) M12x1.75x120mm (x8)		
JB162	JM848			NB975 45x74.5x12mm, FPM PA815 (x1) 78x94x8mm			
JB162	JM848	JH683		NB975 45x74.5x12mm, FPM PA815 (x1) 78x94x8mm	HBS045 [8] ⊕ M12x1.75x105mm (x4) M12x1.75x145mm (x6) M12x1.75x120mm (x8)		
JD298 ■ JD299 ■	JN621 [23] JN622 [22]	JJ543	HR758 ■	NA5131 45x67x8mm, PTFE NB974 93x114x13mm, FPM	HBS059 [8] ⊕ M10x1.50x80mm (x5) M10x1.50x115mm (x6) M10x1.50x102mm (x11)		
JD298 ■ JD299 ■	JN621	JJ543	HR758 ■	NB973 45x67x8mm, FPM NA5131 45x67x8mm, PTFE NB974 93x114x13mm, FPM	HBS059 [8] ⊕ M10x1.50x80mm (x5) M10x1.50x115mm (x6) M10x1.50x102mm (x11)		
JD298 ■ JD299 ■	JN621	JJ543	HR758 ■	NA5131 45x67x8mm, PTFE NB974 93x114x13mm, FPM	HBS059 [8] ⊕ M10x1.50x80mm (x5) M10x1.50x115mm (x6) M10x1.50x102mm (x11)		
JD298 ■ JD299 ■	JN622	JJ543	HR758 ■	NB973 45x67x8mm, FPM NA5131 45x67x8mm, PTFE NB974 93x114x13mm, FPM	HBS059 [8] ⊕ M10x1.50x80mm (x5) M10x1.50x115mm (x6) M10x1.50x102mm (x11)		
JD298 ■ JD299 ■	JN622	JJ543	HR758 ■	NB973 45x67x8mm, FPM NA5131 45x67x8mm, PTFE NB974 93x114x13mm, FPM NA5074 [24] 93x133.5x15.5mm, PTFE	HBS059 [8] ⊕ M10x1.50x80mm (x5) M10x1.50x115mm (x6) M10x1.50x102mm (x11)		

JD298 ■ JD299 ■	JN622	JJ543	HR758 ■	■ NA5131 ■ 45x67x8mm, PTFE ■ NA5074 ■ [24] 93x133.5x15.5mm, PTFE	HBS059 [8] ⊕ M10x1.50x80mm (x5) M10x1.50x115mm (x6) M10x1.50x102mm (x11)	 BC800 BS310 BW380 JD298 JD299 JN273 JN622 JH683 JJ543
JD297 ■	JN273	JH683		■ NB975 ■ 45x74.5x12mm, FPM ■ PA815 ■ (x1) 78x94x8mm	HBS046 [8] ⊕ M12x1.75x145mm (x8) M12x1.75x120mm (x9) M12x1.75x105mm (x5)	 BW380 JD298 JD299 JN273 JN622 JH683 JJ543
JD297 ■	JN273	JH683		■ NB975 ■ 45x74.5x12mm, FPM ■ PA815 ■ (x1) 78x94x8mm	HBS046 [8] ⊕ M12x1.75x145mm (x8) M12x1.75x120mm (x9) M12x1.75x105mm (x5)	 BW380 JD298 JD299 JN273 JN622 JH683 JJ543
		HC463 ■ JJ556	PB177 (x4) [25] ■ 10x15/19x14 860N (ACM) PB172 (x4) [26] ■ 9x15/19x14 860N (ACM) Eng.468 000 → HR668 ■ →Eng.467 999 HR666 ■ Eng.468 000 →	■ NB979 ■ 65x90x15mm, FPM →Eng.369 095 ■ LB955 ■ (x2) 90x107x8mm ■ NB978 ■ 65x90x13mm, FPM Eng.369 096 →		 JN273 JN622 JH683 JJ543

MERCEDES-BENZ



cc



kW/PS

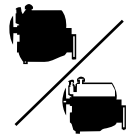

19	OM 364.983	3972	4	97.50	OM 364 LA/Euro 1/ Turbo Intercooled		BS310 (Fibre)	DS310	ES311 [27]
	OM 364.908/OM 364.909	3972	4	97.50	OM 364	50/68			
	OM 364.916	3972	4	97.50	Euro 1	58/79			
	OM 364.917	3972	4	97.50	Euro 1	60/82			
	OM 364.918/OM 364.919/ OM 364.920	3972	4	97.50	OM 364	63/86			
	OM 364.921	3972	4	97.50	OM 364/Euro 1	63/86			
	OM 364.905/OM 364.906/ OM 364.907/OM 364.911/ OM 364.912/OM 364.913/ OM 364.914	3972	4	97.50	OM 364	66/89			
	OM 364.951/OM 364.953	3972	4	97.50	OM 364 A/Turbo	66/89			
	OM 374.907	3972	4	97.50	OM 364	66/89			
	OM 364.955	3972	4	97.50	OM 364 A/Turbo	75/102			
	OM 354.900/OM 354.901/ OM 354.902/OM 354.903	3972	4	97.50	OM 364 LA/Euro 2/ Turbo Intercooled	77/105			
	OM 364.956	3972	4	97.50	Euro 1/Turbo Intercooled	77/105			
	OM 364.957/OM 364.958	3972	4	97.50	OM 364 A/Turbo	77/105			
	OM 364.959	3972	4	97.50	Euro 1/Turbo	77/105			
	OM 364.901	3972	4	97.50	OM 364 A/Turbo	83/113			
	OM 364.950/OM 364.952	3972	4	97.50	OM 364 A/Turbo	85/115			
	OM 364.954	3972	4	97.50	OM 364	85/115			
	OM 364.982	3972	4	97.50	OM 364 LA/Turbo Intercooled	98/133			
	OM 364.980/OM 364.981/ OM 364.984	3972	4	97.50	OM 364 LA/Turbo Intercooled	100/136			
	OM 364.985	3972	4	97.50	OM 364 LA/Turbo Intercooled	100-103/ 136-140			
	OM 364.986/OM 364.987	3972	4	97.50	OM 364 LA/Turbo Intercooled	100/136			
	OM 364.989	3972	4	97.50	Euro 1/Turbo Intercooled	100/136			
	OM 354.920/OM 354.921/ OM 354.922/OM 354.923/ OM 354.924/OM 354.925	3972	4	97.50	OM 364 LA/Euro 2/ Turbo Intercooled	103/140			
OM 354.926	3972	4	97.50	Euro 2/Turbo Intercooled	103/140				
20	OM 380.943	3972	4	97.50	Turbo	79/107	BS310 (Fibre)		ES311 [27]
	OM 384.908	3972	4	97.50	Euro 1/Turbo	79/107			
	OM 380.940/OM 380.942/ OM 384.907	3972	4	97.50	Turbo	85/116			

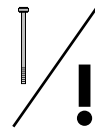
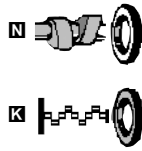
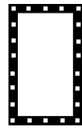
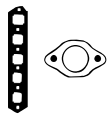

BS310

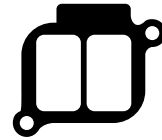

JD114



JD119

JD114 ■ (x2)
JD119 ■ (x3)

HC463 ■
JJ556

HR666 ■

■ NB978 ■ 65x90x13mm, FPM
■ LB955 ■ (x2) 90x107x8mm

JD114 ■ (x2)
JD119 ■ (x3)

HC463 ■

MERCEDES-BENZ



cc



kW/PS

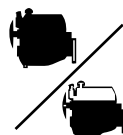

21	OM 904.904/OM 907.910/ OM 907.960	4249	4	102.00	OM 904 LA/Euro 2/ Turbo Intercooled	75/102	AC5931 (SE)	CC5930 ■ ○ [28] CC5931 ■ ○ [29]	EC5850
	OM 904.905/OM 904.909/ OM 904.915/OM 904.918/ OM 904.944	4249	4	102.00	OM 904 LA/Euro 2/ Turbo Intercooled	90/122			
	OM 904.946/OM 904.950	4249	4	102.00	OM 904 LA/Euro 2/ Turbo Intercooled	90-110/ 122-150			
	OM 904.961	4249	4	102.00	OM 904 LA/Euro 3/ Turbo Intercooled	90/122			
	OM 907.920/OM 907.970	4249	4	102.00	OM 904 LA/Euro 2/ Turbo Intercooled	90/122			
	OM 904.906/OM 904.908/ OM 904.910/OM 904.914/ OM 904.916/OM 904.919/ OM 904.924/OM 904.930/ OM 907.930/OM 907.980	4249	4	102.00	OM 904 LA/Euro 2/ Turbo Intercooled	100/136			
	OM 904.927/OM 904.936/ OM 904.953/OM 904.955/ OM 904.957/OM 904.965/ OM 904.966	4249	4	102.00	OM 904 LA/Euro 3/ Turbo Intercooled	110/150			
	OM 904.921/OM 904.922/ OM 904.923/OM 904.925/ OM 904.941/OM 904.943	4249	4	102.00	OM 904 LA/Euro 2/ Turbo Intercooled	112/152			
	OM 904.926/OM 904.940/ OM 904.948	4249	4	102.00	OM 904 LA/Euro 2/ Turbo Intercooled	113/154			
	OM 904.907/OM 904.911/ OM 904.917/OM 904.920/ OM 904.929/OM 904.938/ OM 904.945/OM 907.940/ OM 907.941/OM 907.990	4249	4	102.00	OM 904 LA/Euro 2/ Turbo Intercooled	125/170			
	OM 904.933/OM 904.939/ OM 904.949/OM 904.954/ OM 904.959	4249	4	102.00	OM 904 LA/Euro 2/ Turbo Intercooled	128/174			
	OM 904.928/OM 904.942/ OM 904.947/OM 904.951/ OM 904.952/OM 904.962/ OM 904.964/OM 904.967/ OM 904.968	4249	4	102.00	OM 904 LA/Euro 3/ Turbo Intercooled	130/177			
	OM 904.912/OM 904.934/ OM 904.935	4249	4	102.00	OM 904 LA/Euro 2/ Turbo Intercooled	134/182			
	OM 904.931	4249	4	102.00	OM 904 LA/Euro 2/ Turbo Intercooled	135/184			
	OM 904.932/OM 904.937/ OM 904.956	4249	4	102.00	OM 904 LA/Euro 2/ Turbo Intercooled	142/193			
22	OM 900.911	4249	4	102.00	OM 904 LA/Euro 4/ Turbo Intercooled	95/129	AC5931 (SE)		EC5850
	OM 900.912	4249	4	102.00	OM 904 LA/Euro 4/ Turbo Intercooled	115/156			
	OM 900.913	4249	4	102.00	OM 904 LA/Euro 4/ Turbo Intercooled	130/177			

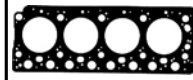
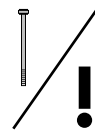
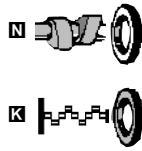
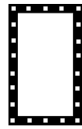
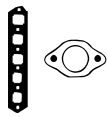

AC5931



JD5283



JE5035



JM5075

JD5283 ■ (x2)
(MLS)
JE5035 ■ (x2)
(MLS)

JM5075 [28]
JM7095 [29]
(Rubber)

JH5094 [30]

☒ NA5120 ■ 78x104x11mm, ACM
☒ NA5121 ■ 115x140x13mm, ACM

HBS351 [8] ⊕
M16x2.0x149mm (x10)

JE5035 ■ (x2)
(MLS)

JM5075 [28]

JH5094 [30]

☒ NA5120 ■ 78x104x11mm, ACM
☒ NA5121 ■ 115x140x13mm, ACM

HBS351 [8] ⊕
M16x2.0x149mm (x10)

MERCEDES-BENZ



cc



kW/PS

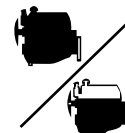

23	OM 900.917/OM 900.922	4249	4	102.00	OM 904 LA/Euro 4/ Turbo Intercooled	95/129	AC5931 (SE)	CC5931 ■ ○ [29]	EC5850
	OM 900.918/OM 900.920	4249	4	102.00	OM 904 LA/Euro 4/ Turbo Intercooled	115/156			
	OM 900.910	4249	4	102.00	OM 904 LA/Turbo Intercooled	128/174			
	OM 900.919/OM 900.921	4249	4	102.00	OM 904 LA/Euro 4/ Turbo Intercooled	130/177			
24	OM 312.954	4580	6	90.00	OM 312	48/65			
25	OM 924.917	4801	4	106.00	OM 924 LA/Euro 3/ Turbo Intercooled	142/193			EC5850
	OM 924.910	4801	4	106.00	OM 924 LA/Euro 3/ Turbo Intercooled	160/218			
	OM 924.911	4801	4	106.00	OM 924 LA/Euro 2/ Turbo Intercooled	160/218			
	OM 924.912/OM 924.914/ OM 924.915/OM 924.916/ OM 924.919	4801	4	106.00	OM 924 LA/Euro 3/ Turbo Intercooled	160/218			
	OM 924.923	4801	4	106.00	OM 924 LA/Euro 4/ Turbo Intercooled	160/218			
	OM 924.924	4801	4	106.00	OM 924 LA/Euro 3/ Turbo Intercooled	160/218			
26	OM 924.920	4801	4	106.00	OM 924 LA/Euro 3/ Turbo Intercooled	160/218			EC5850
	OM 924.922	4801	4	106.00	OM 924 LA/Euro 4/ Turbo Intercooled	160/218			

JD5283 (x2) (MLS) JE5035 (x2) (MLS)	JM5075 [28] JM7095 [29] (Rubber)	JH5094 [30]	<input checked="" type="checkbox"/> NA5120 78x104x11mm, ACM <input checked="" type="checkbox"/> NA5121 115x140x13mm, ACM	HBS351 [8] M16x2.0x149mm (x10)	 AC5931 JD5283 JE5035 JM5075 JJ464
JD5283 (x2) (MLS) JE5035 (x2) (MLS)	JM856 JM5075 [28]	<input checked="" type="checkbox"/> JJ464 [30]	<input checked="" type="checkbox"/> NB979 65x90x15mm, FPM <input checked="" type="checkbox"/> NA5120 78x104x11mm, ACM <input checked="" type="checkbox"/> NA5121 115x140x13mm, ACM	HBS351 [8] M16x2.0x149mm (x10)	
JE5035 (x2) (MLS)	JM5075 [28]	JH5094 [30]	<input checked="" type="checkbox"/> NA5120 78x104x11mm, ACM <input checked="" type="checkbox"/> NA5121 115x140x13mm, ACM	HBS351 [8] M16x2.0x149mm (x10)	



cc



kW/PS

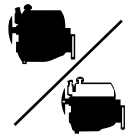

27

OM 352.919	5673	6	97.00	OM 352	48/65
OM 352.902	5673	6	97.00	OM 352	52/71
OM 352.984	5673	6	97.00	OM 352	59/80
OM 353.902	5673	6	97.00	OM 352	62/84
OM 352.903	5673	6	97.00	OM 352	66/89
OM 352.965	5673	6	97.00		69/94
OM 353.962/OM 353.985	5673	6	97.00	OM 352	70/95
OM 352.910/OM 352.942/ OM 352.971/OM 352.972/ OM 352.973/OM 352.974/ OM 352.975/OM 353.901/ OM 353.905/OM 353.967	5673	6	97.00	OM 352	74/100
OM 352.967	5673	6	97.00		74/101
OM 352.966/OM 352.999	5673	6	97.00		79/107
OM 352.906/OM 352.907	5673	6	97.00	OM 352	81/110
OM 352.908	5673	6	97.00	OM 352	81-93/ 110-126
OM 352.909/OM 352.911/ OM 352.914/OM 352.932/ OM 352.933/OM 352.943/ OM 352.970/OM 352.976/ OM 352.979/OM 352.981/ OM 352.982/OM 352.983/ OM 352.985/OM 352.986/ OM 352.989/OM 352.990/ OM 353.903/OM 353.915/ OM 353.916/OM 353.940/ OM 353.949/OM 353.980/ OM 353.998/OM 353.999	5673	6	97.00	OM 352	81/110
OM 353.960	5673	6	97.00	OM 352	88/120
OM 353.907	5673	6	97.00	OM 352	92/125
OM 352.904	5673	6	97.00	OM 352	93/126
OM 352.915	5673	6	97.00		93/126
OM 352.917/OM 352.944/ OM 352.948/OM 352.953/ OM 352.954/OM 352.955/ OM 352.987/OM 352.991	5673	6	97.00	OM 352	93/126
OM 352.992	5673	6	97.00		93/126
OM 352.959	5673	6	97.00		96/126
OM 352.901/OM 352.905/ OM 352.912/OM 352.930/ OM 352.931/OM 352.934/ OM 352.935/OM 352.936/ OM 352.938/OM 352.939/ OM 352.945/OM 352.963/ OM 352.964/OM 352.969	5673	6	97.00	OM 352	96/131
OM 352.978	5673	6	97.00		96/131
OM 352.980/OM 352.993/ OM 352.996/OM 352.997/ OM 352.998/OM 353.900/ OM 353.904/OM 353.917/ OM 353.941/OM 353.942/ OM 353.943/OM 353.944/ OM 353.945/OM 353.946/ OM 353.961/OM 353.963/ OM 353.964/OM 353.965/ OM 353.966/OM 353.968/ OM 353.969/OM 353.981/ OM 353.982/OM 353.983/ OM 353.984/OM 353.988/ OM 353.989	5673	6	97.00	OM 352	96/131
OM 353.977	5673	6	97.00	Turbo	124/169

AS410 (Fibre)

ES411 [27]
Eng.760 549 →

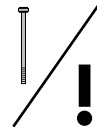
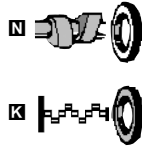
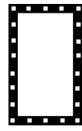
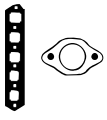

AS410





JJ460



JJ464

JM856

JJ460  [31]

JJ464  [32]

PB177 (x6) [25]



10x15/19x14

860N (ACM)

→Eng.794 938

PB172 (x6) [26]





9x15/19x14

860N (ACM)



Eng.794 939→



HR667 

Eng.794939→

 NB979  65x90x15mm, FPM

→Eng.598249

 LB955  (x2) 90x107x8mm

 NB978  65x90x13mm, FPM

Eng.598250→

MERCEDES-BENZ









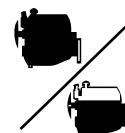



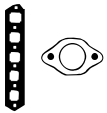

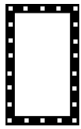

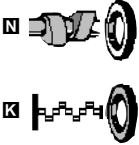
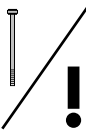











cc



kW/PS



28	OM 353.957/OM 353.973/ OM 353.995	5673	6	97.00	OM 352 A/Turbo	92/125	AS410 (Fibre)	CS413 ■○	ES411 [27] Eng.760 549→ FS414 ○ [7]				
	OM 352 A	5673	6	97.00	Turbo	93/126							
	OM 344.940	5673	6	97.00	OM 352 A/Turbo	96/131							
	OM 344.949	5673	6	97.00	Turbo	96/131							
	OM 352.988	5673	6	97.00	OM 352 A/Turbo	96/131							
	OM 352.916/OM 352.918/ OM 352.937/OM 352.946/ OM 352.950/OM 352.994	5673	6	97.00	OM 352 A/Turbo	110/150							
	OM 353.958	5673	6	97.00	OM 353 A/Turbo	110/150							
	OM 353.976	5673	6	97.00	OM 352 A/Turbo	110/150							
	OM 344.913/OM 344.934/ OM 344.937/OM 344.938/ OM 344.939	5673	6	97.00	OM 352 A/Turbo	115/156							
	OM 344.948	5673	6	97.00	Turbo	115/156							
	OM 344.951	5673	6	97.00		115/156							
	OM 352.913/OM 352.949/ OM 352.968	5673	6	97.00	OM 352 A/Turbo	115/156							
	OM 353.909/OM 353.910/ OM 353.911/OM 353.912/ OM 353.913/OM 353.914/ OM 353.950/OM 353.951/ OM 353.952/OM 353.953/ OM 353.954/OM 353.959/ OM 353.970/OM 353.971/ OM 353.972/OM 353.975/ OM 353.991/OM 353.997	5673	6	97.00	OM 352 A/Turbo	124/168							
	OM 344.952	5673	6	97.00	Turbo	124/169							
	OM 353.974/OM 353.978	5673	6	97.00	OM 352 A/Turbo	127/172							
	29	OM 362.906/OM 362.909/ OM 362.910	5675	6	97.00	OM 362 LA/Turbo Intercooled				141/192	AS410 (Fibre) 01/84→12/86	CS413 ■○ 01/84→12/86	ES411 [27]

						 <p>AS410</p>  <p>JJ460</p>  <p>JJ464</p>
JM856	JJ460  [31] JJ464  [32]	PB177 (x6) [25]  10x15/19x14 860N (ACM) →Eng.794 938 PB172 (x6) [26]  9x15/19x14 860N (ACM) Eng.794 939→ HR667  Eng.794939→	 NB979  65x90x15mm, FPM →Eng.598249  LB955  (x2) 90x107x8mm  NB978  65x90x13mm, FPM Eng.598250→			
JM856	JJ464  	HR667  01/84→12/86	 NB978  65x90x13mm, FPM  LB955  (x2) 90x107x8mm			



cc



kW/PS

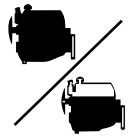

30	OM 376.910	5958	6	97.50	OM 366	69-100/ 94-136	AS410 (Fibre)	CS412 ■	EB990 [27]
	OM 356.901/OM 356.902/ OM 356.904/OM 356.905/ OM 356.906/OM 356.907/ OM 356.908/OM 356.910/ OM 356.911	5958	6	97.50	OM 366/Euro 1	95/129			
	OM 376.908/OM 376.909	5958	6	97.50	OM 366	95/129			
	OM 366.911	5958	6	97.50	Euro 1	96/131			
	OM 356.915	5958	6	97.50	OM 366/Euro 1	97/132			
	OM 356.913	5958	6	97.50	OM 366/Euro 1	100/136			
	OM 366.905/OM 366.906/ OM 366.907/OM 366.909/ OM 366.910/OM 366.913/ OM 366.914/OM 366.917/ OM 366.919/OM 366.930/ OM 366.932/OM 366.933/ OM 366.936/OM 366.938/ OM 366.940/OM 376.905/ OM 376.906/OM 376.907/ OM 376.930	5958	6	97.50	OM 366	100/136			
	OM 382.912	5958	6	97.50		100/136			
	OM 386.906	5958	6	97.50	Turbo	100/136			
	OM 356.944/OM 356.946/ OM 356.948/OM 356.949/ OM 356.951/OM 356.953/ OM 356.958/OM 366.941/ OM 366.943	5958	6	97.50	OM 366 A/Euro 1/Turbo	116/158			
	OM 356.943/OM 366.942	5958	6	97.50	OM 366 A/Euro 1/Turbo	121/165			
	OM 357.900/OM 357.901/ OM 357.902/OM 357.903/ OM 357.904/OM 357.908/ OM 357.915/OM 357.916/ OM 357.917/OM 357.918/ OM 357.919/OM 357.963	5958	6	97.50	OM 366 LA/Turbo Intercooled	125/170			
	OM 366.945/OM 366.946/ OM 366.951/OM 366.953/ OM 366.957/OM 366.960/ OM 366.962/OM 366.965/ OM 366.967/OM 366.968/ OM 366.969/OM 366.970/ OM 366.971/OM 366.973/ OM 366.979	5958	6	97.50	OM 366 A/Turbo	125/170			
	OM 382.913	5958	6	97.50	Turbo	125/170			
	OM 356.940/OM 366.952	5958	6	97.50	OM 366 A/Turbo	129/175			
	OM 366.980/OM 366.981	5958	6	97.50	OM 366 LA/Turbo Intercooled	148/201			
	OM 366.988	5958	6	97.50	OM 366 LA/Turbo Intercooled	148-150/ 201-204			
	OM 366.997	5958	6	97.50	OM 366 LA/Euro 1/ Turbo Intercooled	148-150/ 201-204			
	OM 356.985/OM 366.983/ OM 366.990/OM 366.993/ OM 366.995/OM 366.996	5958	6	97.50	OM 366 LA/Turbo Intercooled	150/204			
	OM 382.919/OM 382.971	5958	6	97.50	Turbo	150/204			
	OM 356.978	5958	6	97.50	OM 366 LA/Euro 1/ Turbo Intercooled	155/211			
	OM 356.984/OM 356.986/ OM 356.987/OM 356.990/ OM 356.992/OM 356.993	5958	6	97.50	OM 366 LA/Turbo Intercooled	155/211			

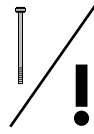
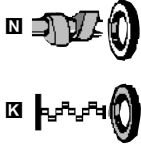
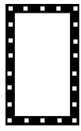
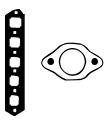

AS410



JD114



JD119



JN888



JJ464

JD114 ■ (x3)
JD119 ■ (x4)

JN888

JJ464 ■

PB172 ■ (x6)
9x15/19x14
860N (ACM)
HR667 ■

■ NB978 ■ 65x90x13mm, FPM
■ LB955 ■ (x2) 90x107x8mm

MERCEDES-BENZ









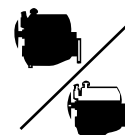



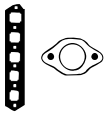

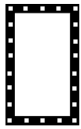

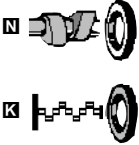
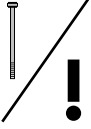

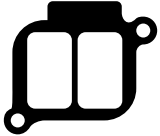

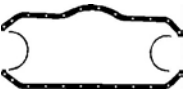













cc



kW/PS



31	OM 366.912	5958	6	97.50	OM 366	74/100	AS410 (Fibre)	CS412 ■	EB990 [27]
	OM 366.915	5958	6	97.50	OM 366	75/102			
	OM 366.908/OM 366.939	5958	6	97.50	OM 366	81/110			
	OM 366.949	5958	6	97.50	OM 366 A/Turbo	92-115/ 125-156			
	OM 366.977	5958	6	97.50	OM 366 A/Turbo	92/125			
	OM 366.947	5958	6	97.50	OM 366 A/Turbo	100/136			
	OM 366.948	5958	6	97.50	OM 366 A/Turbo	100-115/ 136-156			
	OM 366.955/OM 366.956/ OM 366.958	5958	6	97.50	OM 366 A/Turbo	100/136			
	OM 366.954	5958	6	97.50	OM 366 A/Turbo	115-132/ 156-180			
	OM 366.963	5958	6	97.50	OM 366 A/Turbo	125/170			
OM 366.984	5958	6	97.50	OM 366 LA/Turbo Intercooled	150-157/ 204-214				
32	OM 356.914	5958	6	97.50	OM 366/Euro 1	75/102	AS410 (Fibre)	CS412 ■	
	OM 356.912	5958	6	97.50	OM 366/Euro 1	81/110			
	OM 356.950/OM 356.954	5958	6	97.50	OM 366 A/Euro 1/Turbo	92/125			
	OM 357.912	5958	6	97.50	OM 366 LA/Euro 2/ Turbo Intercooled	100/136			
	OM 356.955	5958	6	97.50	OM 366 A/Euro 1/Turbo	114/155			
	OM 356.956	5958	6	97.50	OM 366 A/Euro 1/Turbo	114-115/ 155-156			
	OM 357.913	5958	6	97.50	OM 366 LA/Euro 2/ Turbo Intercooled	120/163			
	OM 356.957	5958	6	97.50	OM 366 A/Euro 1/Turbo	122/166			
	OM 356.981	5958	6	97.50	OM 366 LA/Turbo Intercooled	127/172			
	OM 356.998	5958	6	97.50	OM 366 LA/Turbo Intercooled	132/180			
OM 356.997	5958	6	97.50	OM 366 LA/Turbo Intercooled	157/214				
33	OM 356.903/OM 356.909	5958	6	97.50	OM 366/Euro 1	95/129	AS410 (Fibre)	CS412 ■	EB990 [27]
	OM 356.916	5958	6	97.50	OM 366/Euro 1	97/132			
	OM 366.918/OM 366.931/ OM 366.935/OM 366.937	5958	6	97.50	OM 366	100/136			
	OM 356.941/OM 356.945/ OM 356.947/OM 356.952	5958	6	97.50	OM 366 A/Euro 1/Turbo	116/158			
	OM 356.959	5958	6	97.50	OM 366 A/Euro 1/Turbo	121/165			
	OM 357.906/OM 357.907/ OM 357.909/OM 357.910	5958	6	97.50	OM 366 LA/Turbo Intercooled	125/170			
	OM 366.944/OM 366.966/ OM 366.974/OM 366.975/ OM 366.976/OM 366.978	5958	6	97.50	OM 366 A/Turbo	125/170			
	OM 366.992/OM 366.994	5958	6	97.50	OM 366 LA/Turbo Intercooled	150/204			
	OM 356.994/OM 356.995	5958	6	97.50	OM 366 LA/Turbo Intercooled	155/211			
	34	OM 382.916	5958	6	97.50	OM 366			
OM 382.917		5958	6	97.50	OM 366 A/Turbo	110/150			
OM 382.950		5958	6	97.50	OM 366 A/Turbo	125/170			

						 AS410  JD114  JD119  JN888  JJ460
JD114  (x3) JD119  (x4)	JN888		PB172  (x6) 9x15/19x14 860N (ACM) HR667 	<input checked="" type="checkbox"/> NB978  65x90x13mm, FPM <input checked="" type="checkbox"/> LB955  (x2) 90x107x8mm		
JD114  (x3) JD119  (x4)	JN888		PB172  (x6) 9x15/19x14 860N (ACM) HR667 	<input checked="" type="checkbox"/> NB978  65x90x13mm, FPM <input checked="" type="checkbox"/> LB955  (x2) 90x107x8mm		
JD114  (x3) JD119  (x4)	JN888	JJ460  [31]	PB172  (x6) 9x15/19x14 860N (ACM) HR667 	<input checked="" type="checkbox"/> NB978  65x90x13mm, FPM <input checked="" type="checkbox"/> LB955  (x2) 90x107x8mm		
JD119  (x4)	JN888		PB172  (x6) 9x15/19x14 860N (ACM) HR667 	<input checked="" type="checkbox"/> NB978  65x90x13mm, FPM <input checked="" type="checkbox"/> LB955  (x2) 90x107x8mm		



cc



Ø



kW/PS

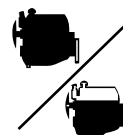

35

OM 357.961/OM 357.962	5958	6	97.50	OM 366 LA/Turbo Intercooled	125/170
OM 376.945/OM 376.950/ OM 376.951/OM 376.952/ OM 376.953/OM 376.954	5958	6	97.50	OM 366 A/Turbo Intercooled	125/170
OM 376.955	5958	6	97.50	OM 366 A/Turbo	125/170
OM 376.956/OM 376.957/ OM 376.958/OM 376.961	5958	6	97.50	OM 366 A/Turbo Intercooled	125/170
OM 376.962	5958	6	97.50	OM 366 A	125/170
OM 376.963	5958	6	97.50	OM 366 LA/Turbo Intercooled	125/170
OM 376.964	5958	6	97.50	OM 366 A/Turbo Intercooled	125/170
OM 376.967	5958	6	97.50	OM 366 A	125/170
OM 386.950/OM 386.951/ OM 386.952	5958	6	97.50	Turbo	125/170
OM 376.969/OM 376.970/ OM 376.976/OM 376.977	5958	6	97.50	OM 366 LA/Turbo Intercooled	127/173
OM 376.980/OM 376.987	5958	6	97.50	OM 366 LA MBTC-USA/ Turbo Intercooled	127/173
OM 376.995	5958	6	97.50	OM 366 LA/Turbo Intercooled	127/173
OM 376.946/OM 376.947	5958	6	97.50	OM 366 A/Turbo Intercooled	131/178
OM 376.998/OM 376.999	5958	6	97.50	OM 366 LA MBTC-USA/ Turbo Intercooled	134/182
OM 376.972/OM 376.997	5958	6	97.50	OM 366 LA/Turbo Intercooled	140/190
OM 376.981/OM 376.982/ OM 376.988/OM 376.989	5958	6	97.50	OM 366 LA MBTC-USA/ Turbo Intercooled	142/193
OM 376.941/OM 376.984/ OM 376.986/OM 376.993	5958	6	97.50	OM 366 LA/Turbo Intercooled	150/204
OM 386.980/OM 386.981/ OM 386.983	5958	6	97.50	Turbo Intercooled	150/204
OM 356.996/OM 357.920/ OM 357.921/OM 357.922/ OM 357.925/OM 357.926/ OM 357.927/OM 357.929/ OM 357.930	5958	6	97.50	OM 366 LA/Turbo Intercooled	155/211
OM 357.931	5958	6	97.50	OM 366 LA/Euro 2/ Turbo Intercooled	155/211
OM 357.932/OM 357.933	5958	6	97.50	OM 366 LA/Turbo Intercooled	155/211
OM 357.936/OM 357.937	5958	6	97.50	OM 366 LA/Euro 2/ Turbo Intercooled	155/211
OM 357.938	5958	6	97.50	Euro 2/Turbo Intercooled	155/211
OM 376.994	5958	6	97.50	OM 366 LA/Turbo Intercooled	155/211
OM 376.968/OM 376.975	5958	6	97.50	OM 366 LA/Turbo Intercooled	156/212
OM 366.999	5958	6	97.50	OM 366 LA/Euro 1/ Turbo Intercooled	170/231
OM 356.977	5958	6	97.50	OM 366 LA/Euro 1/ Turbo Intercooled	177/240
OM 356.979/OM 356.980	5958	6	97.50	OM 366 LA/Turbo Intercooled	177/240
OM 356.983	5958	6	97.50	OM 366 LA/Euro 1/ Turbo Intercooled	177/240
OM 356.999/OM 357.940/ OM 357.941/OM 357.942/ OM 357.946/OM 357.947/ OM 357.948	5958	6	97.50	OM 366 LA/Turbo Intercooled	177/240
OM 357.949	5958	6	97.50	OM 366 LA/Euro 2/ Turbo Intercooled	177/240
OM 356.988	5958	6	97.50	Euro 1/Turbo Intercooled	177/241
OM 382.970	5958	6	97.50	Turbo Intercooled	177/241

AS410 (Fibre)

EB990 [27]

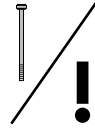
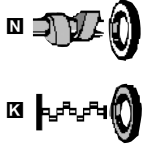
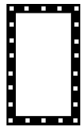
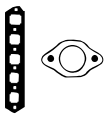

AS410



JD114





JD119



JN888









JJ464

JD114  (x3)
JD119  (x4)

JN888

JJ464 

PB172  (x6)
9x15/19x14
860N (ACM)
HR667 

 NB978  65x90x13mm, FPM
 LB955  (x2) 90x107x8mm

MERCEDES-BENZ



cc



kW/PS

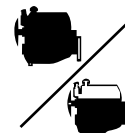

36	OM 357.924	5958	6	97.50	OM 366 LA/Euro 2/ Turbo Intercooled	155/211	AS410 (Fibre)		
	OM 357.945	5958	6	97.50	OM 366 LA/Euro 2/ Turbo Intercooled	177/240			
37	OM 356.989/OM 356.991/ OM 357.943/OM 357.944	5958	6	97.50	OM 366 LA/Turbo Intercooled	177/240	AS410 (Fibre)		EB990 [27]
38	OM 902.910/OM 902.911/ OM 902.912/OM 902.913/ OM 902.914/OM 902.915/ OM 902.919/OM 902.920/ OM 902.921/OM 902.922/ OM 902.927/OM 902.930/ OM 902.931/OM 902.932/ OM 902.933				OM 906 LA/Euro 4/ Turbo Intercooled		AC5841 (SE)	CC5841 ■○ [33]	EC5840
	OM 902.916	6374	6	102.00	OM 906 LA/Euro 4/ Turbo Intercooled	175/231			
	OM 902.923	6374	6	102.00	OM 906 LA/Euro 4/ Turbo Intercooled/Straight	175/238			
	OM 902.917	6374	6	102.00	OM 906 LA/Euro 4/ Turbo Intercooled	188/256			
	OM 902.918	6374	6	102.00	OM 906 LA/Euro 4/ Turbo Intercooled	210/286			

JD114 (x3) JD119 (x4)	JN888		PB172 (x6) 9x15/19x14 860N (ACM) HR667	<input checked="" type="checkbox"/> NB978 65x90x13mm, FPM <input checked="" type="checkbox"/> LB955 (x2) 90x107x8mm	<input checked="" type="checkbox"/> AC5841 <input checked="" type="checkbox"/> AS410
JD114 (x3) JD119 (x4)	JN888	JJ460 [31]	PB172 (x6) 9x15/19x14 860N (ACM) HR667	<input checked="" type="checkbox"/> NB978 65x90x13mm, FPM <input checked="" type="checkbox"/> LB955 (x2) 90x107x8mm	
JD5283 (x3) (MLS) JE5035 (x3) (MLS)		JH5095		<input checked="" type="checkbox"/> NA5120 78x104x11mm, ACM <input checked="" type="checkbox"/> NA5121 115x140x13mm, ACM	



cc



kW/PS

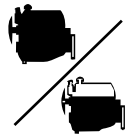

39

OM 906.944/OM 906.957	6374	6	102.00	OM 906 LA/Euro 2/ Turbo Intercooled	142/193
OM 906.978	6374	6	102.00	OM 906 LA/Euro 2/ Turbo Intercooled	142-157/ 193-214
OM 906.914/OM 906.945/ OM 906.958/OM 906.959	6374	6	102.00	OM 906 LA/Euro 2/ Turbo Intercooled	157/214
OM 906.910/OM 906.913/ OM 906.915/OM 906.917/ OM 906.920/OM 906.922/ OM 906.924	6374	6	102.00	OM 906 LA/Euro 2/ Turbo Intercooled	170/231
OM 906.925/OM 906.927	6374	6	102.00	OM 906 LA/Euro 3/ Turbo Intercooled	170/231
OM 906.931	6374	6	102.00	OM 906 HLA/Euro 2/ Turbo Intercooled	170/231
OM 906.935	6374	6	102.00	OM 906 LA/Euro 3/ Turbo Intercooled	170/231
OM 906.937/OM 906.940	6374	6	102.00	OM 906 LA/Euro 2/ Turbo Intercooled	170/231
OM 906.951	6374	6	102.00	OM 906 LA/Turbo Intercooled	170/231
OM 906.964/OM 906.971	6374	6	102.00	OM 906 LA/Turbo Intercooled	170-180/ 231-245
OM 906.982	6374	6	102.00	OM 906 LA/Turbo Intercooled	170/231
OM 909.900	6374	6	102.00	OM 906 HLA/Turbo Intercooled	170/231
OM 909.910/OM 909.911/ OM 909.960	6374	6	102.00	OM 906 LA/Turbo Intercooled	170/231
OM 906.979	6374	6	102.00	OM 906 LA/Euro 2/ Turbo Intercooled	172-187/ 193-254
OM 906.968	6374	6	102.00	OM 906 LA/Euro 2/ Turbo Intercooled	172-187/ 230-254
OM 906.929/OM 906.932/ OM 906.936/OM 906.954/ OM 906.966	6374	6	102.00	OM 906 LA/Euro 2/ Turbo Intercooled	172/234
OM 906.918/OM 906.919	6374	6	102.00	OM 906 LA/Euro 2/ Turbo Intercooled	180/245
OM 906.939/OM 906.949/ OM 906.962	6374	6	102.00	OM 906 LA/Euro 3/ Turbo Intercooled	180/245
OM 906.963	6374	6	102.00	OM 906 HLA/Euro 3/ Turbo Intercooled	180/245
OM 906.975	6374	6	102.00	OM 906 LA/Euro 2/ Turbo Intercooled	180/245
OM 906.983	6374	6	102.00	OM 906 LA/Turbo Intercooled	180/245
OM 906.985/OM 906.988	6374	6	102.00	OM 906 LA/Euro 2/ Turbo Intercooled	180/245
OM 906.946	6374	6	102.00	OM 906 LA/Euro 2/ Turbo Intercooled	187/254
OM 906.970	6374	6	102.00	OM 906 LA/Euro 2/ Turbo Intercooled	194-209/ 194-284
OM 906.980	6374	6	102.00	OM 906 LA/Euro 2/ Turbo Intercooled	194-209/ 260-280
OM 906.912/OM 906.947	6374	6	102.00	OM 906 LA/Euro 2/ Turbo Intercooled	194/265
OM 906.911/OM 906.916/ OM 906.921/OM 906.923	6374	6	102.00	OM 906 LA/Euro 2/ Turbo Intercooled	205/279
OM 906.926/OM 906.928	6374	6	102.00	OM 906 LA/Euro 3/ Turbo Intercooled	205/279
OM 906.930	6374	6	102.00	OM 906 HLA/Euro 2/ Turbo Intercooled	205/279
OM 906.938	6374	6	102.00	OM 906 LA/Euro 3/ Turbo Intercooled	205/279
OM 906.941	6374	6	102.00	OM 906 LA/Euro 2/ Turbo Intercooled	205/279
OM 906.950/OM 906.952/ OM 906.953/OM 906.955/ OM 906.960/OM 906.961	6374	6	102.00	OM 906 LA/Euro 3/ Turbo Intercooled	205/279
OM 906.965	6374	6	102.00	OM 906 LA/Turbo Intercooled	205/279
OM 909.901	6374	6	102.00	OM 906 HLA/Turbo Intercooled	205/279
OM 909.920/OM 909.921/ OM 909.970/OM 909.971	6374	6	102.00	OM 906 LA/Turbo Intercooled	205/279
OM 906.933/OM 906.934/ OM 906.956/OM 906.967/ OM 906.974/OM 906.976/ OM 906.977	6374	6	102.00	OM 906 LA/Euro 2/ Turbo Intercooled	209/284
OM 906.981	6374	6	102.00	OM 906 LA/Euro 2/ Turbo Intercooled	224/300
OM 906.948	6374	6	102.00	OM 906 LA/Euro 2/ Turbo Intercooled	224/305

AC5841 (SE)

CC5840 [34]
CC5841 [33]

EC5840

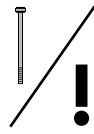
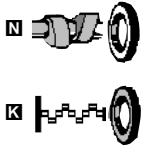
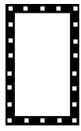
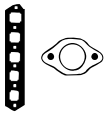

AC5841



JD5283



JE5035

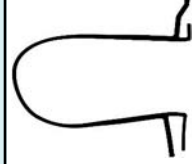

JM5172

JD5283 ■ (x3)
(MLS)
JE5035 ■ (x3)
(MLS)

JM5172 [34]
(ACM)

JH5095

☒ NA5120 ■ 78x104x11mm, ACM
☒ NA5121 ■ 115x140x13mm, ACM

HBS352 [8] ⊕
M16x2.0x149mm (x14)

MERCEDES-BENZ



cc



kW/PS

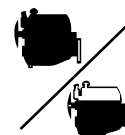

40	M 906.901	6374	6	102.00	M 906 LA G/Euro 2/ Turbo Intercooled	170/231			
	M 906.900/M 906.903	6374	6	102.00	M 906 LA G/Euro 2/ Turbo Intercooled	205/279			
41	OM 926.927/OM 926.928	7201	6	106.00	OM 926 LA/Euro 3/ Turbo Intercooled	187/254			EC5840
	OM 926.938	7201	6	106.00	OM 926 LA/Euro 3/ Turbo Intercooled	205/279			
	OM 926.920	7201	6	106.00	OM 926 LA/Euro 3/ Turbo Intercooled	209/284			
	OM 926.939	7201	6	106.00	OM 926 LA/Euro 4/ Turbo Intercooled	210/286			
	OM 926.918/OM 926.925	7201	6	106.00	OM 926 LA/Euro 3/ Turbo Intercooled	215/292			
	OM 926.929	7201	6	106.00	OM 926 LA/Euro 3/ Turbo Intercooled	220/299			
	OM 926.926/OM 926.930/ OM 926.932	7201	6	106.00	OM 926 LA/Euro 3/ Turbo Intercooled	225/306			
	OM 926.910	7201	6	106.00	OM 926 LA/Euro 3/ Turbo Intercooled	240/326			
	OM 926.911/OM 926.912	7201	6	106.00	OM 926 LA/Euro 2/ Turbo Intercooled	240/326			
	OM 926.913	7201	6	106.00	OM 926 LA/Euro 3/ Turbo Intercooled	240/326			
	OM 926.914	7201	6	106.00	OM 926 LA/Euro 2/ Turbo Intercooled	240/326			
	OM 926.915/OM 926.916/ OM 926.917	7201	6	106.00	OM 926 LA/Euro 3/ Turbo Intercooled	240/326			
	OM 926.919	7201	6	106.00	OM 926 LA/Euro 4/ Turbo Intercooled	240/326			
	OM 926.921/OM 926.924	7201	6	106.00	OM 926 LA/Euro 3/ Turbo Intercooled	240/326			
	OM 926.934	7201	6	106.00	OM 926 LA/Euro 4/ Turbo Intercooled	240/326			
	OM 926.935	7201	6	106.00	OM 926 LA/Euro 3/ Turbo Intercooled	240/326			
	OM 926.937	7201	6	106.00	OM 926 LA/Euro 4/ Turbo Intercooled	240/326			
42	OM 327.934/OM 327.935/ OM 327.945/OM 327.946	7980	6	115.00	OM 327	110/150			
	OM 327.910/OM 327.916/ OM 327.931/OM 327.932/ OM 327.938/OM 327.939/ OM 327.943/OM 327.944	7980	6	115.00	OM 327	118/160			
	OM 327.914/OM 327.915/ OM 327.917/OM 327.918/ OM 327.919/OM 327.933/ OM 327.936/OM 327.937/ OM 327.940/OM 327.941/ OM 327.942	7980	6	115.00	OM 327	125/170			

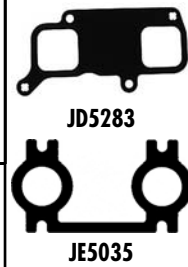
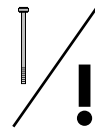
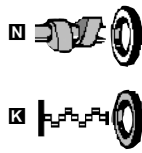
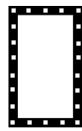
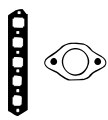

JD5283 ■ (x3)
(MLS)

JE5035 ■ (x3)
(MLS)

JD5283 ■ (x3)
(MLS)

JE5035 ■ (x3)
(MLS)

JH5095

JH5095

☒ NA5120 ■ 78x104x11mm, ACM
☒ NA5121 ■ 115x140x13mm, ACM

☒ NA5120 ■ 78x104x11mm, ACM
☒ NA5121 ■ 115x140x13mm, ACM

HBS352 [8] ☉
M16x2.0x149mm (x14)

HBS352 [8] ☉
M16x2.0x149mm (x14)

PB177 (x12)
10x15/19x14
860N (ACM)

☒ NB977 ■ [35] 75x100x12mm, FPM

MERCEDES-BENZ



cc



kW/PS

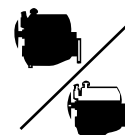

43	OM 360.973	8725	6	115.00		81/110				
	OM 360.968/OM 360.969/ OM 360.970	8725	6	115.00		93/126				
	OM 360.911	8725	6	115.00	OM 360 H	125/170				
	OM 360.916/OM 360.917/ OM 360.918/OM 360.933	8725	6	115.00	OM 360	125/170				
	OM 360.935	8725	6	115.00		125/170				
	OM 360.936/OM 360.939/ OM 360.948/OM 360.949	8725	6	115.00	OM 360	125/170				
	OM 360.950/OM 360.951/ OM 360.952	8725	6	115.00		125/170				
	OM 360.979	8725	6	115.00	OM 360	125/170				
	OM 360.983	8725	6	115.00	Turbo	125/170				
	OM 360.937/OM 360.938/ OM 360.940/OM 360.942/ OM 360.943/OM 360.944/ OM 360.946	8725	6	115.00	OM 360	127/172				
	OM 360.962/OM 360.967	8725	6	115.00		127/173				
	OM 360.914/OM 360.915/ OM 360.931/OM 360.941	8725	6	115.00	OM 360	141/192				
	OM 360.960/OM 360.961/ OM 360.963/OM 360.964/ OM 360.965/OM 360.966/ OM 360.971/OM 360.972/ OM 360.975	8725	6	115.00		141/192				
	OM 360.980/OM 360.981	8725	6	115.00	OM 360	141/192				
	OM 360.985	8725	6	115.00	OM 360 A/Turbo	141/192				
	OM 360.982	8725	6	115.00	Turbo	154/209				
	OM 360.984/OM 360.986	8725	6	115.00	OM 360 A/Turbo	154/210				
	44	OM 409.906/OM 409.907/ OM 409.908	9204	5	125.00	OM 409	135/184	AH5450 (Fibre) (x5)[21] BG850 (SE) (x5)	DG853 (x5) DG854 ○ (x5)	
	45	OM 401.905/OM 401.906/ OM 401.907/OM 401.908/ OM 401.909/OM 401.912/ OM 401.913/OM 401.914/ OM 401.915/OM 401.916/ OM 401.918/OM 401.919/ OM 401.921/OM 401.922/ OM 401.923/OM 401.925/ OM 401.926/OM 401.927/ OM 401.928	9572	6	125.00	OM 401/V	141/192	AH5450 (Fibre) (x6)[21] BG850 (SE) (x6)	DG850 ○ (x6) →Eng.001 206 DG853 (x6) Eng.001 207→ DG854 ○ (x6) Eng.001 207→	EX851
		OM 401.917	9572	6	125.00	OM 401 A/Turbo/V	188/256			

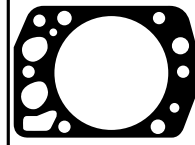
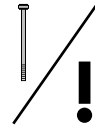
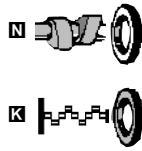
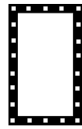
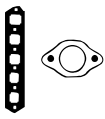

BG850

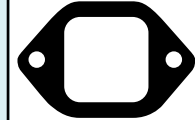

JB179

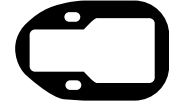

JD117

			PB177 (x12) 10x15/19x14 860N (ACM)	<input checked="" type="checkbox"/> NB977 [F] [35] 75x100x12mm, FPM	
JD117 [I] (x5) JB179 [I] (x5)			PB224 (x10) 12x16/20x15 860N (FPM)	<input checked="" type="checkbox"/> NB928 [I] 105x130x12mm, FPM <input checked="" type="checkbox"/> NB929 [I] 120x140x13mm, FPM	HBS226 (x5)[8] ☉ M15x2.0x168mm (x2) M15x2.0x144mm (x3) M15x2.0x109mm (x1) HT018 (x5)[14] [S] HT020 (x5)[14] [S] HT021 (x5)[14] [S]
JD117 [I] (x6) JB179 [I] (x6)	JN977 (x6) Eng.001 207 →	JJ280	PB224 (x12) 12x16/20x15 860N (FPM)	<input checked="" type="checkbox"/> NB928 [I] 105x130x12mm, FPM <input checked="" type="checkbox"/> NB929 [I] 120x140x13mm, FPM	HBS226 (x6)[8] ☉ M15x2.0x168mm (x2) M15x2.0x144mm (x3) M15x2.0x109mm (x1) HT018 (x6)[14] [S] HT020 (x6)[14] [S] HT021 (x6)[14] [S]

MERCEDES-BENZ







cc

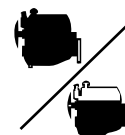

kW/PS

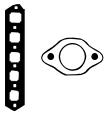

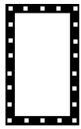
46	OM 401.975/OM 401.976	9572	6	125.00	OM 401 LA/Euro 1/ Turbo Intercooled/V	180/245	AH5450 (Fibre) (x6)[21] BG850 (SE) (x6)	DG853 (x6) DG854 ○ (x6)	EX851
	OM 401.983/OM 401.984/ OM 401.990/OM 401.994	9572	6	125.00	OM 401 LA/Turbo Intercooled/V	180/245			
	OM 401.973	9572	6	125.00	OM 401 LA/Turbo Intercooled/V	200/272			
	OM 401.974/OM 401.977/ OM 401.978/OM 401.980	9572	6	125.00	OM 401 LA/Euro 1/ Turbo Intercooled/V	200/272			
	OM 401.985/OM 401.989/ OM 401.991/OM 401.992	9572	6	125.00	OM 401 LA/Turbo Intercooled/V	200/272			
	OM 401.970	9572	6	125.00	OM 401 LA/Turbo Intercooled/V	213/290			
	OM 401.972	9572	6	125.00	OM 401 LA/Turbo Intercooled/V	230/313			
	OM 401.979/OM 401.981/ OM 401.982	9572	6	125.00	OM 401 LA/Euro 1/ Turbo Intercooled/V	230/313			
	OM 401.986/OM 401.987/ OM 401.993	9572	6	125.00	OM 401 LA/Turbo Intercooled/V	230/313			
	47	OM 429.951	9970	5	128.00	OM 429 LA/Turbo Intercooled			
OM 429.953		9970	5	128.00	OM 429 A/Turbo	186/253			
OM 429.955		9970	5	128.00	OM 429 LA/Turbo Intercooled	186/253			
48	OM 489.960	9973	5	128.00	Euro 1/Turbo Intercooled	155/211	AH5450 (Fibre) (x5)[21] BG850 (SE) (x5)	DG853 (x5) DG854 ○ (x5)	
	OM 489.961	9973	5	128.00	Euro 1/Turbo Intercooled	184/250			
49	OM 401.924	10456	6	125.00	OM 401/V	144/196	AH5450 (Fibre) (x6)[21] BG850 (SE) (x6)	DG850 ○ (x6) →Eng.001 206 DG853 (x6) Eng.001 207 → DG854 ○ (x6) Eng.001 207 →	EX851
50	OM 326.912/OM 326.914/ OM 326.918	10809	6	128.00	OM 326	110/150			
	OM 326.911	10809	6	128.00	OM 326 H	132/180			
	OM 326.971/OM 326.972/ OM 326.973/OM 326.974/ OM 326.975/OM 326.988	10809	6	128.00	OM 326	132/180			
	OM 326.910/OM 326.915	10809	6	128.00	OM 326	147/200			
	OM 326.977	10809	6	128.00	OM 326 H	147/200			
	OM 326.980/OM 326.983	10809	6	128.00	OM 326	147/200			
51	OM 346.918	10809	6	128.00	OM 346 H	132/180	AH5390 (Fibre) (x6) AS450 (Fibre) (x2)		
	OM 346.914/OM 346.915/ OM 346.916/OM 346.943/ OM 346.944/OM 346.945/ OM 346.946/OM 346.953	10809	6	128.00	OM 346	136/185			
	OM 346.952	10809	6	128.00	OM 346	141/192			
	OM 346.910	10809	6	128.00	OM 346	155/211			
	OM 346.911	10809	6	128.00	OM 346 H	155/211			
	OM 346.912/OM 346.913/ OM 346.917/OM 346.941/ OM 346.942	10809	6	128.00	OM 346	155/211			

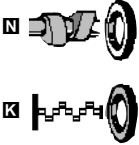
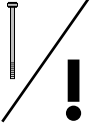
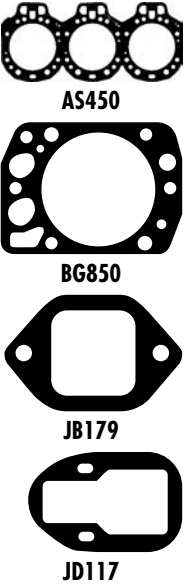
						
JD117 ■ (x6) JB179 ■ (x6)	JN977 (x6)	JJ280	PB224 (x12) 12x16/20x15 860N (FPM)	■ NB928 ■ 105x130x12mm, FPM ■ NB929 ■ 120x140x13mm, FPM	HBS226 (x6) [8] ☉ M15x2.0x168mm (x2) M15x2.0x144mm (x3) M15x2.0x109mm (x1) HT018 (x6) [14] ■	
JD117 ■ (x5)	JN977 (x5)		PB224 (x10) 12x16/20x15 860N (FPM)	■ NB928 ■ 105x130x12mm, FPM ■ NB929 ■ 120x140x13mm, FPM	HBS226 (x5) [8] ☉ M15x2.0x168mm (x2) M15x2.0x144mm (x3) M15x2.0x109mm (x1) HT021 (x5) [14] ■ →Eng.039 041 HT018 (x5) [14] ■ Eng.039 042→	
JD117 ■ (x5) JB179 ■ (x5)	JN977 (x5)		PB224 (x10) 12x16/20x15 860N (FPM)	■ NB928 ■ 105x130x12mm, FPM ■ NB929 ■ 120x140x13mm, FPM	HBS226 (x5) [8] ☉ M15x2.0x168mm (x2) M15x2.0x144mm (x3) M15x2.0x109mm (x1) HT018 (x5) [14] ■	
JD117 ■ (x6) JB179 ■ (x6)	JN977 (x6) Eng.001 207→	JJ280	PB224 (x12) 12x16/20x15 860N (FPM)	■ NB928 ■ 105x130x12mm, FPM ■ NB929 ■ 120x140x13mm, FPM	HBS226 (x6) [8] ☉ M15x2.0x168mm (x2) M15x2.0x144mm (x3) M15x2.0x109mm (x1) HT018 (x6) [14] ■ HT020 (x6) [14] ■ HT021 (x6) [14] ■	
				■ NB977 ■ [35] 75x100x12mm, FPM ■ NB984 ■ 66.67x89.3x10mm, FPM		
			HR769 ■ (x2)	■ NB977 ■ [35] 75x100x12mm, FPM ■ NB984 ■ 66.67x89.3x10mm, FPM		

MERCEDES-BENZ



cc



kW/PS

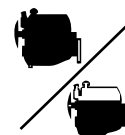

52	OM 421.905/OM 421.906/ OM 421.907/OM 421.908/ OM 421.909/OM 421.910	10964	6	128.00	OM 421/V	159/216	AH5450 (Fibre) (x6)[21] BG850 (SE) (x6)	DG853 (x6) DG854 ○ (x6)	EX851				
	OM 481.902/OM 481.904	10964	6	128.00	V	159/216							
	OM 421.951	10964	6	128.00	OM 421 A/Turbo/V	184/250							
	OM 441.906/OM 441.907	10964	6	130.00	OM 441/V	150/204							
	OM 441.927	10964	6	130.00	OM 441/V	153/208							
	OM 441.908/OM 441.909/ OM 441.911	10964	6	130.00	OM 441/V	160-165/ 218-224							
	OM 441.917/OM 441.923/ OM 441.925/OM 441.926	10964	6	130.00	OM 441/V	160/218							
	OM 441.905/OM 441.913/ OM 441.915	10964	6	130.00	OM 441/V	165/224							
	53	OM 445.924/OM 445.925/ OM 445.938/OM 445.941	10964	6	128.00	OM 441 LA/Euro 2/ Turbo Intercooled/V				180/245	AH5450 (Fibre) (x6)[21] BG850 (SE) (x6)	DG853 (x6) DG854 ○ (x6)	EX851
		OM 441.952	10964	6	128.00	OM 441 A/Turbo/V				191/260			
OM 441.953		10964	6	128.00	OM 441 A/Turbo/V	191-200/ 260-272							
OM 441.950		10964	6	128.00	OM 441 A/Turbo/V	200/272							
OM 445.926/OM 445.927/ OM 445.933/OM 445.936/ OM 445.940		10964	6	128.00	OM 441 LA/Euro 2/ Turbo Intercooled/V	200/272							
OM 445.935		10964	6	128.00	OM 441 LA/Euro 2/ Turbo Intercooled/V	213/290							
OM 441.997/OM 441.998		10964	6	128.00	OM 441 LA/Euro 1/ Turbo Intercooled/V	230/313							
OM 445.929/OM 445.930/ OM 445.931/OM 445.937		10964	6	128.00	OM 441 LA/Euro 2/ Turbo Intercooled/V	230/313							
OM 441.951		10964	6	128.00	OM 441 LA/Turbo Intercooled/V	243/330							
OM 441.960/OM 441.962/ OM 441.981/OM 441.983		10964	6	128.00	OM 441 LA/Turbo Intercooled/V	243-249/ 330-340							
OM 441.961/OM 441.980/ OM 441.982/OM 441.985		10964	6	128.00	OM 441 LA/Turbo Intercooled/V	250/340							
OM 441.986/OM 441.987/ OM 441.988/OM 441.989/ OM 441.990/OM 441.991/ OM 441.992/OM 441.993/ OM 441.994/OM 441.995/ OM 441.996/OM 441.999		10964	6	128.00	OM 441 LA/Euro 1/ Turbo Intercooled/V	250/340							
OM 445.920/OM 445.921/ OM 445.922/OM 445.923/ OM 445.934/OM 445.939		10964	6	128.00	OM 441 LA/Euro 2/ Turbo Intercooled/V	250/340							
54		OM 407.905/OM 407.908	11045	6	125.00	OM 407 H	132/180	AH5450 (Fibre) (x6)[21] BG850 (SE) (x6)	DG850 ○ (x6) →Eng.002 809 DG853 (x6) Eng.002 810→ DG854 ○ (x6) Eng.002 810→	GG856 →Eng.002 809			
		OM 407.907/OM 407.909/ OM 407.910/OM 407.911	11045	6	125.00	OM 407 H	155/211						

JD117 ■ (x6) JB179 ■ (x6)	JN977 (x6)	JJ280	PB224 (x12) 12x16/20x15 860N (FPM)	<input checked="" type="checkbox"/> NB928 ■ 105x130x12mm, FPM <input checked="" type="checkbox"/> NB929 ■ 120x140x13mm, FPM	HBS226 (x6) [8] ☉ M15x2.0x168mm (x2) M15x2.0x144mm (x3) M15x2.0x109mm (x1) HTO21 (x6) [14] ■ →Eng.535 118 HTO18 (x6) [14] ■ Eng.535 119→	BG850 JB179 JD117 JJ495
JD117 ■ (x6) JB179 ■ (x6)	JN977 (x6)	JJ280	PB224 (x12) 12x16/20x15 860N (FPM)	<input checked="" type="checkbox"/> NB928 ■ 105x130x12mm, FPM <input checked="" type="checkbox"/> NB929 ■ 120x140x13mm, FPM	HBS226 (x6) [8] ☉ M15x2.0x168mm (x2) M15x2.0x144mm (x3) M15x2.0x109mm (x1) HTO18 (x6) [14] ■	
JD117 ■ (x6) JB179 ■ (x6)	JN977 (x6) Eng.002 810→	JJ495	PB224 (x12) 12x16/20x15 860N (FPM)	<input checked="" type="checkbox"/> NB928 ■ 105x130x12mm, FPM <input checked="" type="checkbox"/> NB929 ■ 120x140x13mm, FPM	HBS226 (x6) [8] ☉ M15x2.0x168mm (x2) M15x2.0x144mm (x3) M15x2.0x109mm (x1) HTO20 (x6) [14] ■	

MERCEDES-BENZ



cc



kW/PS

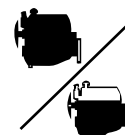

55	OM 441.922	11309	6	130.00	OM 441/Euro 1/V	151/205	AH5450 (Fibre) (x6)[21] BG850 (SE) (x6)	DG853 (x6) DG854 ○ (x6)	EX851	
	OM 441.932	11309	6	130.00	OM 441/V	151/205				
	OM 441.933	11309	6	130.00	OM 441/Euro 1/V	151/205				
	OM 441.916/OM 441.919/ OM 441.920	11309	6	130.00	OM 441/V	153/208				
	OM 441.910/OM 441.924	11309	6	130.00	OM 441/V	160/218				
	OM 441.912/OM 441.914/ OM 441.918/OM 441.921	11309	6	130.00	OM 441/V	165/224				
56	OM 407.913/OM 407.914/ OM 407.915	11413	6	125.00	OM 407 H	147/200	AH5450 (Fibre) (x6)[21] BG850 (SE) (x6)	DG850 ○ (x6) →Eng.002 809 DG853 (x6) Eng.002 810 → DG854 ○ (x6) Eng.002 810 →	GG856 →Eng.002 809	
	OM 407.916/OM 407.917/ OM 407.918/OM 407.919/ OM 407.920	11413	6	125.00	OM 407 H	177/240				
	OM 407.951	11413	6	125.00	OM 407 HA/Turbo	206/280				
	OM 407.955	11413	6	125.00	Turbo	206/280				
57	OM 355.972	11581	6	128.00	OM 355 H	136/185	AS450 (Fibre) (x2)			
	OM 355.961	11581	6	128.00	OM 355 H	155/211				
	OM 355.966	11581	6	128.00	OM 355	155/211				
	OM 355.910/OM 355.911/ OM 355.912/OM 355.913/ OM 355.914/OM 355.915	11581	6	128.00	OM 355	169/230				
	OM 355.916	11581	6	128.00		169/230				
	OM 355.918	11581	6	128.00	OM 355	169/230				
	OM 355.960/OM 355.963/ OM 355.975/OM 355.976	11581	6	128.00	OM 355	176/240				
	OM 355.962/OM 355.964/ OM 355.967	11581	6	128.00	OM 355	177/240				
	OM 355.973	11581	6	128.00	OM 355 H	177/240				
	OM 355.974/OM 355.978/ OM 355.979/OM 355.980/ OM 355.983/OM 355.984	11581	6	128.00	OM 355	177/240				
	OM 355.981/OM 355.982	11581	6	128.00	OM 355	184/250				
	OM 355.968	11581	6	128.00	OM 355/Straight	191/260				
	OM 355.970	11581	6	128.00	OM 355	191/260				
	OM 355.977	11581	6	128.00	OM 355 A/Turbo	205/279				
	OM 355.969	11581	6	128.00	OM 355 A/Turbo	206/280				

						 AS450
JD117 (x6) JB179 (x6)	JN977 (x6)	JJ280	PB224 (x12) 12x16/20x15 860N (FPM)	NB928 105x130x12mm, FPM NB929 120x140x13mm, FPM	HBS226 (x6) [8] M15x2.0x168mm (x2) M15x2.0x144mm (x3) M15x2.0x109mm (x1) HT021 (x6) [14] →Eng.535 118 HT018 (x6) [14] Eng.535 119→	 BG850
JD117 (x6) JB179 (x6)	JN977 (x6) Eng.002 810→	JJ495	PB224 (x12) 12x16/20x15 860N (FPM)	NB928 105x130x12mm, FPM NB929 120x140x13mm, FPM	HBS226 (x6) [8] M15x2.0x168mm (x2) M15x2.0x144mm (x3) M15x2.0x109mm (x1) HT020 (x6) [14]	 JB179
				NB977 [35] 75x100x12mm, FPM		 JD117
						 JJ495



cc



kW/PS

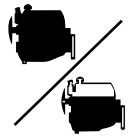

58

OM 541.920/OM 541.926	11946	6	130.00	OM 501 LA/Turbo Intercooled/V	230/313
OM 541.940/OM 541.941/ OM 541.951	11946	6	130.00	OM 501 LA/Turbo Intercooled/V	230-235/ 313-320
OM 541.952	11946	6	130.00	OM 501 LA/Turbo Intercooled/V	230-260/ 313-354
OM 941.910/OM 941.960	11946	6	130.00	OM 501 LA/Euro 2/ Turbo Intercooled/V	230/313
OM 541.970	11946	6	130.00	OM 501 LA/Euro 4/ Turbo Intercooled/V	235/320
OM 541.971	11946	6	130.00	OM 501 LA/Turbo Intercooled/V	235/320
OM 521.950	11946	6	130.00	OM 501 LA/Euro 2/ Turbo Intercooled/V	260/354
OM 541.922	11946	6	130.00	OM 501 LA/Turbo Intercooled/V	260/354
OM 541.927	11946	6	130.00	OM 501 LA/Euro 2/ Turbo Intercooled/V	260/354
OM 541.942/OM 541.943	11946	6	130.00	OM 501 LA/Euro 3/ Turbo Intercooled/V	260-265/ 354-360
OM 541.950	11946	6	130.00	OM 501 LA/Euro 3/ Turbo Intercooled/V	260-300/ 354-408
OM 941.920/OM 941.921/ OM 941.970	11946	6	130.00	OM 501 LA/Euro 2/ Turbo Intercooled/V	260/354
OM 541.972/OM 541.973	11946	6	130.00	OM 501 LA/Euro 4/ Turbo Intercooled/V	265/360
OM 541.923/OM 541.924	11946	6	130.00	OM 501 LA/Turbo Intercooled/V	290/394
OM 541.944	11946	6	130.00	OM 501 LA/Euro 3/ Turbo Intercooled/V	290-335/ 394-456
OM 541.945	11946	6	130.00	OM 501 LA/Euro 3/ Turbo Intercooled/V	290-300/ 394-408
OM 941.929/OM 941.980	11946	6	130.00	OM 501 LA/Euro 2/ Turbo Intercooled/V	290/394
OM 941.981	11946	6	130.00	OM 501 LA/Euro 2/ Turbo Intercooled/V	290-315/ 394-428
OM 541.974/OM 541.975	11946	6	130.00	OM 501 LA/Euro 4/ Turbo Intercooled/V	300/408
OM 941.930	11946	6	130.00	OM 501 LA/Euro 2/ Turbo Intercooled/V	300/408
OM 941.940	11946	6	130.00	OM 501 LA/Euro 2/ Turbo Intercooled/V	300/428
OM 521.940/OM 541.921	11946	6	130.00	OM 501 LA/Euro 2/ Turbo Intercooled/V	315/428
OM 541.925	11946	6	130.00	OM 501 LA/Turbo Intercooled/V	315/428
OM 541.928	11946	6	130.00	OM 501 LA/Euro 2/ Turbo Intercooled/V	315/428
OM 541.946/OM 541.947	11946	6	130.00	OM 501 LA/Euro 3/ Turbo Intercooled/V	315-320/ 428-435
OM 941.990	11946	6	130.00	OM 501 LA/Euro 2/ Turbo Intercooled/V	315/428
OM 541.976/OM 541.977	11946	6	130.00	OM 501 LA/Euro 4/ Turbo Intercooled/V	320/435
OM 541.948/OM 541.949/ OM 541.980/OM 541.981	11946	6	130.00	OM 501 LA/Euro 3/ Turbo Intercooled/V	335/456
OM 541.978	11946	6	130.00	OM 501 LA/Euro 3/ Turbo Intercooled/V	350/476

BZ140 (SE) (x6)

→Eng.357748

AG8280 (SE) (x6)

Eng.357749→

DZ140 (x6)

→Eng.084423

DZ141 (x6)

Eng.084424→

→Eng.155295

DZ142 (x6)

Eng.155296→

→Eng.357748

DZ143 (x6)

Eng.357749→

EC330

→Eng.012090

EC521

Eng.012091→

→Eng.089131

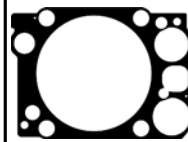
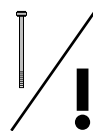
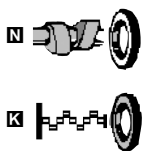
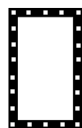
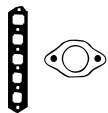

BZ140

JD5086 (x6)
JA5077 (x6)

JM5186 (x6)
(Rubber)
→Eng.084423
JM5187 (x6)
(Rubber)
Eng.084424→
→Eng.155295
JM5270 (x6)
(Rubber)
Eng.155296→

JH5018
→Eng.012090
JH5072
(Rubber)
Eng.012091→

NB928 105x130x12mm, FPM
NB929 120x140x13mm, FPM

HBS350 (x6) [8] ©
M18x2.0x210mm (x4)
HT5038 (x6) [14]

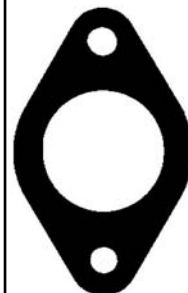

JA5077



JM5270

MERCEDES-BENZ









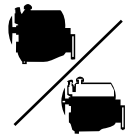

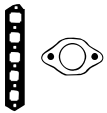

cc

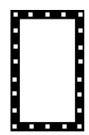

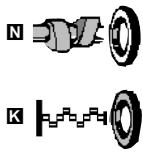
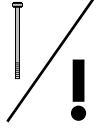
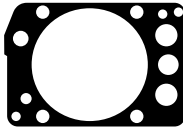
kW/PS

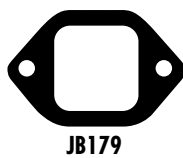

59	OM 457.914/OM 457.916/ OM 457.920/OM 457.923/ OM 457.927/OM 457.932	11967	6	128.00	OM 457 LA/Euro 3/ Turbo Intercooled		AF5370 (SE) (x6)	CF5370 (x6)	EF5370
60	OM 457.915	11967	6	128.00	OM 457 LA/Euro 3/ Turbo Intercooled		AF5370 (SE) (x6)	CF5370 (x6)	
61	OM 457.918 OM 457.951 OM 457.953 OM 457.961 OM 457.962 OM 457.917 OM 457.948	11967 11967 11967 11967 11967 11967 11967	6 6 6 6 6 6 6	128.00 128.00 128.00 128.00 128.00 128.00 128.00	OM 457 LA/Euro 3/ Turbo Intercooled OM 457 LA/Euro 4/ Turbo Intercooled/Straight OM 457 LA/Euro 4/ Turbo Intercooled/Straight OM 457 LA/Euro 3/ Turbo Intercooled/Straight OM 457 LA/Euro 3/ Turbo Intercooled/Straight OM 457 LA/Turbo Intercooled	 260/354 260-315/ 354-428 260-355/ 354-483 260-315/ 354-428 315-260/ 428-354 315-260/ 428-354	AF5370 (SE) (x6)		
62	OM 457.919	11967	6	128.00	OM 457 LA/Euro 3/ Turbo Intercooled		AF5370 (SE) (x6)		EF5370
63	OM 457.922	11967	6	128.00	OM 457 LA/Euro 3/ Turbo Intercooled		AF5370 (SE) (x6)		EF5370
64	OM 457.924/OM 457.928	11967	6	128.00	OM 457 LA/Euro 3/ Turbo Intercooled		AF5370 (SE) (x6)		EF5370
65	OM 457.925/OM 457.926/ OM 457.929 OM 457.931	11967 11967	6 6	128.00 128.00	Euro 3/Turbo Intercooled OM 457 LA/Euro 3/ Turbo Intercooled		AF5370 (SE) (x6)		EF5370

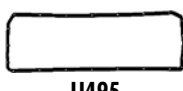
     							
JD5431 ■ (x6) (SE) JA5077 ■ (x6)	JM7043 (x6) [3] (Fibre) →Eng.794619 JM5270 (x6) [29] (Rubber) Eng.794620→	JJ495		NB928 ■ 105x130x12mm, FPM NB929 ■ 120x140x13mm, FPM	HBS475 (x6) [8] ☉ M15x2x210mm (x4) HL5077 (x6) [14] ■ KA5038 [10] Soft Material Gasket JR5038 [11] (Fibre)		
JD5431 ■ (x6) (SE) JA5077 ■ (x6)	JM7043 (x6) [3] (Fibre) →Eng.794619 JM5270 (x6) [29] (Rubber) Eng.794620→			NB928 ■ 105x130x12mm, FPM NB929 ■ 120x140x13mm, FPM	HBS475 (x6) [8] ☉ M15x2x210mm (x4) HL5077 (x6) [14] ■ KA5038 [10] Soft Material Gasket JR5038 [11] (Fibre)		
JA5077 ■ (x6)	JM5270 (x6) [29] (Rubber)			NB928 ■ 105x130x12mm, FPM NB929 ■ 120x140x13mm, FPM	HBS475 (x6) [8] ☉ M15x2x210mm (x4) HL5077 (x6) [14] ■ KA5038 [10] Soft Material Gasket JR5038 [11] (Fibre)		
JD5431 ■ (x6) (SE) JA5077 ■ (x6)		JJ495		NB928 ■ 105x130x12mm, FPM NB929 ■ 120x140x13mm, FPM	HBS475 (x6) [8] ☉ M15x2x210mm (x4) HL5077 (x6) [14] ■ KA5038 [10] Soft Material Gasket JR5038 [11] (Fibre)		
JB179 ■ (x6)		JJ495		NB928 ■ 105x130x12mm, FPM NB929 ■ 120x140x13mm, FPM	HBS475 (x6) [8] ☉ M15x2x210mm (x4) HL5077 (x6) [14] ■ KA5038 [10] Soft Material Gasket JR5038 [11] (Fibre)		
JD5431 ■ (x6) (SE) JB179 ■ (x6)	JM7043 (x6) [3] (Fibre) →Eng.794619 JM5270 (x6) [29] (Rubber) Eng.794620→	JJ495		NB928 ■ 105x130x12mm, FPM NB929 ■ 120x140x13mm, FPM	HBS475 (x6) [8] ☉ M15x2x210mm (x4) HL5077 (x6) [14] ■ KA5038 [10] Soft Material Gasket JR5038 [11] (Fibre)		
JD5431 ■ (x6) (SE) JB179 ■ (x6)	JM7043 (x6) (Fibre)	JJ495		NB928 ■ 105x130x12mm, FPM NB929 ■ 120x140x13mm, FPM	HBS475 (x6) [8] ☉ M15x2x210mm (x4) HL5077 (x6) [14] ■ KA5038 [10] Soft Material Gasket JR5038 [11] (Fibre)		

MERCEDES-BENZ



cc



Ø



kW/PS

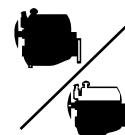

66	OM 457.939/OM 457.945/ OM 457.946/OM 457.949 OM 457.940	11967	6	128.00	OM 457 LA/Euro 2/ Turbo Intercooled	260/354	AF5370 (SE) (x6)	CF5370 (x6)	EF5370
		11967	6	128.00	OM 457 LA/Euro 3/ Turbo Intercooled				
	OM 457.936	11967	6	128.00	OM 457 LA/Euro 2/ Turbo Intercooled				
67	OM 427.905	11967	6	128.00	OM 427 H	150/204	AH5450 (Fibre) (x6)[21] BG850 (SE) (x6)		
	OM 427.910/OM 427.911	11967	6	128.00	OM 427 H	177/240			
	OM 427.950/OM 427.951/ OM 427.952	11967	6	128.00	OM 427 HA/Turbo	206/280			
68	OM 447.905/OM 447.911	11967	6	128.00	OM 447 H	150/204	AH5450 (Fibre) (x6)[21] BG850 (SE) (x6)		
	OM 447.913/OM 447.914	11967	6	128.00	OM 447 H/Euro 1	157/214			
	OM 447.970	11967	6	128.00	OM 447 HLA/Euro 2/ Turbo Intercooled	157/214			
	OM 447.906	11967	6	128.00	OM 447 H	177-184/ 240-250			
	OM 447.907/OM 447.908	11967	6	128.00	OM 447 H	177/240			
	OM 447.910	11967	6	128.00	OM 447 H	177/240			
	OM 447.912	11967	6	128.00	OM 447 H	184/250			
	OM 447.954/OM 447.955/ OM 447.956/OM 447.958	11967	6	128.00	OM 447 HA/Euro 1/Turbo	184/250			
	OM 447.971/OM 447.990/ OM 447.992	11967	6	128.00	OM 447 HLA/Euro 2/ Turbo Intercooled	184/250			
	OM 447.950/OM 447.951	11967	6	128.00	OM 447 HA/Turbo	206/280			
	OM 447.952/OM 447.953	11967	6	128.00	OM 447 HA/Euro 1/Turbo	206/280			
	OM 447.980/OM 447.985	11967	6	128.00	OM 447 HLA/Euro 1/ Turbo Intercooled	220/299			
	OM 447.991/OM 447.993/ OM 447.994	11967	6	128.00	OM 447 HLA/Euro 2/ Turbo Intercooled	220/299			
	OM 447.981/OM 447.982/ OM 447.983/OM 447.987	11967	6	128.00	OM 447 HLA/Euro 1/ Turbo Intercooled	220/300			
	OM 447.988	11967	6	128.00	OM 447 HLA/Euro 2/ Turbo Intercooled	220/300			
	OM 447.968	11967	6	128.00	OM 447 HLA/Euro 2/ Turbo Intercooled	235/320			

JD5431 ■ (x6) (SE) JA5077 ■ (x6)	JM7043 (x6) [3] (Fibre) →Eng.023559 JM5270 (x6) [29] (Rubber) Eng.032560→	JJ495		NB928 ■ 105x130x12mm, FPM NB929 ■ 120x140x13mm, FPM	HBS475 (x6) [8] ⊙ M15x2x210mm (x4) HL5077 (x6) [14] ■ KA5038 [10] Soft Material Gasket JR5038 [11] (Fibre)	 AF5370 JM7043 JJ495
JD117 ■ (x6)	JN977 (x6)	JJ495	PB224 (x12) 12x16/20x15 860N (FPM)	NB928 ■ 105x130x12mm, FPM NB929 ■ 120x140x13mm, FPM	HBS226 (x6) [8] ⊙ M15x2.0x168mm (x2) M15x2.0x144mm (x3) M15x2.0x109mm (x1) HTO21 (x6) [14] ■ →Eng.535 118 HTO18 (x6) [14] ■ Eng.535 119→	 BG850
JD117 ■ (x6)	JN977 (x6)	JJ495	PB224 (x12) 12x16/20x15 860N (FPM)	NB928 ■ 105x130x12mm, FPM NB929 ■ 120x140x13mm, FPM	HBS226 (x6) [8] ⊙ M15x2.0x168mm (x2) M15x2.0x144mm (x3) M15x2.0x109mm (x1) HTO21 (x6) [14] ■ →Eng.039 041 HTO18 (x6) [14] ■ Eng.039 042→	 JA5077 JD117 JD5431 JM5270

MERCEDES-BENZ









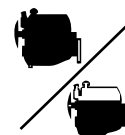



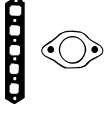

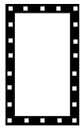
cc

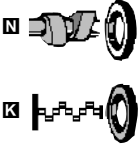
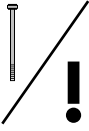
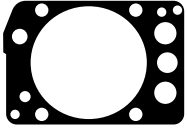
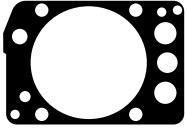
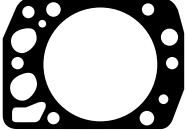

kW/PS

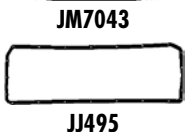

69	OM 447.949/OM 447.973	11967	6	128.00	OM 447 HLA/Euro 2/ Turbo Intercooled	157/214	AH5450 (Fibre) (x6)[21] BG850 (SE) (x6)		
	OM 447.960	11967	6	128.00	OM 447 HLA/Euro 1/ Turbo Intercooled	184/250			
	OM 447.974/OM 447.976	11967	6	128.00	OM 447 HLA/Euro 2/ Turbo Intercooled	184/250			
	OM 447.978	11967	6	128.00	OM 447 HLA/Turbo Intercooled	184/250			
	OM 447.995	11967	6	128.00	OM 447 HA/Euro 1/Turbo	184/250			
	OM 447.996	11967	6	128.00	OM 447 HLA/Euro 2/ Turbo Intercooled	184/250			
	OM 447.947	11967	6	128.00	OM 447 HLA/Euro 1/ Turbo Intercooled	220/299			
	OM 447.948/OM 447.972	11967	6	128.00	OM 447 HLA/Euro 2/ Turbo Intercooled	220/299			
	OM 447.975	11967	6	128.00	OM 447 HLA/Euro 1/ Turbo Intercooled	220/299			
	OM 447.977/OM 447.979/ OM 447.998 OM 447.999	11967	6	128.00	OM 447 HLA/Euro 2/ Turbo Intercooled OM 447 HLA/Euro 2/ Turbo Intercooled/Straight	220/299 220/299			
70	M 476.921	11967	6	128.00	Turbo Intercooled	175/238	BG850 (SE) (x6)		
	M 476.920/M 476.925/ M 476.926/M 476.927 M 476.932	11967	6	128.00	Turbo Intercooled	177/241			
	M 476.933/M 476.934	11967	6	128.00	M 447 HLA G/Euro 2/ Turbo Intercooled	185/252			
	M 476.935	11967	6	128.00	M 447 HLAG/Euro 2/ Turbo Intercooled/Straight	185-240/ 252-326			
	M 476.930	11967	6	128.00	M 447 HLA G/Euro 2/ Turbo Intercooled	240/326			
71	OM 447.957/OM 447.959	11967	6	128.00	OM 447 HA/Euro 1/Turbo	184/250	AH5450 (Fibre) (x6)[21] BG850 (SE) (x6)	DG853 (x6) DG854 ○ (x6)	
	OM 447.984/OM 447.986	11967	6	128.00	OM 447 HLA/Euro 1/ Turbo Intercooled	220/300			
72	OM 457.935	11967	6	128.00	OM 457 HLA/Euro 3/ Turbo Intercooled	185/252	AF5370 (SE) (x6)	CF5370 (x6)	EF5370
	OM 457.934	11967	6	128.00	OM 457 HLA/Euro 3/ Turbo Intercooled	220/299			
	OM 457.933	11967	6	128.00	OM 457 HLA/Euro 3/ Turbo Intercooled	260/354			
	OM 457.938	11967	6	128.00	OM 457 HLA/Euro 2/ Turbo Intercooled	300/408			
73	OM 457.941	11967	6	128.00	OM 457 HLA/Euro 3/ Turbo Intercooled	185-300/ 252-408	AF5370 (SE) (x6) →Eng.85588		EF5370
	OM 457.942	11967	6	128.00	OM 457 HLA/Euro 3/ Turbo Intercooled	185-260/ 252-354			

						
JD117 ■ (x6)	JN977 (x6)	JJ495	PB224 (x12) 12x16/20x15 860N (FPM)	☒ NB928 ■ 105x130x12mm, FPM ☒ NB929 ■ 120x140x13mm, FPM	HBS226 (x6) [8] ☉ M15x2.0x168mm (x2) M15x2.0x144mm (x3) M15x2.0x109mm (x1) HTO18 (x6) [14] ■	 <p>AF5370</p>  <p>BG850</p>  <p>JB179</p>  <p>JD117</p>  <p>JD5431</p>
JB179 ■ (x6)	JN977 (x6)	JJ495	PB224 (x12) 12x16/20x15 860N (FPM)	☒ NB928 ■ 105x130x12mm, FPM ☒ NB929 ■ 120x140x13mm, FPM	HBS226 (x6) [8] ☉ M15x2.0x168mm (x2) M15x2.0x144mm (x3) M15x2.0x109mm (x1) HTO18 (x6) [14] ■ KA5038 [10] Soft Material Gasket	 <p>JM5270</p>  <p>JM7043</p>
JD117 ■ (x6) JB179 ■ (x6)	JN977 (x6)	JJ495	PB224 (x12) 12x16/20x15 860N (FPM)	☒ NB928 ■ 105x130x12mm, FPM ☒ NB929 ■ 120x140x13mm, FPM	HBS226 (x6) [8] ☉ M15x2.0x168mm (x2) M15x2.0x144mm (x3) M15x2.0x109mm (x1) HTO21 (x6) [14] ■ →Eng.039 041 HTO18 (x6) [14] ■ Eng.039 042→	 <p>JM7043</p>  <p>JJ495</p>
JD5431 ■ (x6) (SE)	JM7043 (x6) [3] (Fibre) →Eng.023559 JM5270 (x6) [29] (Rubber) Eng.032560→	JJ495		☒ NB928 ■ 105x130x12mm, FPM ☒ NB929 ■ 120x140x13mm, FPM	HBS475 (x6) [8] ☉ M15x2x210mm (x4) HL5077 (x6) [14] ■ KA5038 [10] Soft Material Gasket JR5038 [11] (Fibre)	
	JM7043 (x6) [3] (Fibre) →Eng.023559 JM5270 (x6) [29] (Rubber) Eng.032560→	JJ495		☒ NB928 ■ 105x130x12mm, FPM ☒ NB929 ■ 120x140x13mm, FPM	HBS475 (x6) [8] ☉ M15x2x210mm (x4) HL5077 (x6) [14] ■ KA5038 [10] Soft Material Gasket JR5038 [11] (Fibre)	

MERCEDES-BENZ









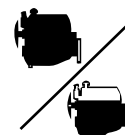

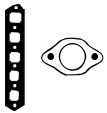

cc

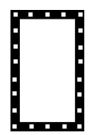

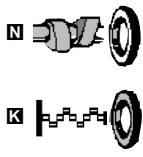
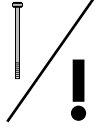
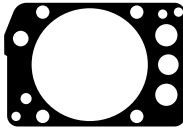
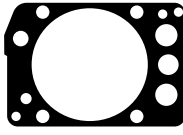
kW/PS

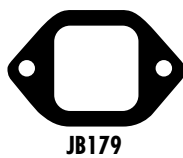

74	OM 457.943	11967	6	128.00	OM 457 LA/Euro 3/ Turbo Intercooled	185/252	AF5370 (SE) (x6) →Eng.85588	CF5370 (x6)	EF5370
	OM 457.944	11967	6	128.00	OM 457 LA/Euro 3/ Turbo Intercooled	260-310/ 354-422			
75	OM 457.964	11967	6	128.00	OM 457 HLA/Euro 4/ Turbo Intercooled/Straight	220-260/ 299-408	AF5370 (SE) (x6)		
	OM 457.965	11967	6	128.00	OM 457 HLA/Euro 4/ Turbo Intercooled/Straight	220-300/ 299-408			
	OM 457.966	11967	6	128.00	OM 457 HLA/Euro 4/ Turbo Intercooled/Straight	220-260/ 299-354			
	OM 457.950/OM 457.954/ OM 457.959	11967	6	128.00	OM 457 HLA/Euro 4/ Turbo Intercooled	260-220/ 354-299			
	OM 457.952	11967	6	128.00	OM 457 HLA/Euro 4/ Turbo Intercooled	300-220/ 408-299			
76	OM 457.937	11967	6	128.00	OM 457 LA/Euro 3/ Turbo Intercooled	260-315/ 354-428	AF5370 (SE) (x6) →Eng.85588	CF5370 (x6)	
	OM 457.947	11967	6	128.00	OM 457 LA/Euro 2/ Turbo Intercooled	315-260/ 428-354			
77	OM 458.960	11967	6	128.00	OM 457 LA/Euro 3/ Turbo Intercooled	260/354	AF5370 (SE) (x6)		EF5370
78	OM 458.970	11967	6	128.00	OM 457 LA/Euro 3/ Turbo Intercooled	295/401	AF5370 (SE) (x6) →Eng.85588		
	OM 458.980	11967	6	128.00	OM 457 LA/Euro 3/ Turbo Intercooled	335/456			
79	OM 457.955	11967	6	128.00	OM 457 LA/Euro 3/ Turbo Intercooled	315-260/ 428-354	AF5370 (SE) (x6)		EF5370
80	OM 457.956	11967	6	128.00	OM 457 LA/Euro 3/ Turbo Intercooled	315-260/ 428-354	AF5370 (SE) (x6) →Eng.85588		
81	OM 457.957	11967	6	128.00	OM 457 LA/Euro 3/ Turbo Intercooled	315-260/ 428-354			
	OM 457.958	11967	6	128.00	OM 457 LA/Turbo Intercooled	315-230/ 428-313			

     					
JD5431 ■ (x6) (SE) JA5077 ■ (x6)	JM5270 (x6) [29] (Rubber)	JJ495	<input checked="" type="checkbox"/> NB928 ■ 105x130x12mm, FPM <input checked="" type="checkbox"/> NB929 ■ 120x140x13mm, FPM	HBS475 (x6) [8] ☉ M15x2x210mm (x4) HL5077 (x6) [14] ■ KA5038 [10] Soft Material Gasket JR5038 [11] (Fibre)	 AF5370  JA5077  JB179  JD5431  JM5270  JM7043  JJ495
	JM5270 (x6) [29] (Rubber)		<input checked="" type="checkbox"/> NB928 ■ 105x130x12mm, FPM <input checked="" type="checkbox"/> NB929 ■ 120x140x13mm, FPM	HBS475 (x6) [8] ☉ M15x2x210mm (x4) HL5077 (x6) [14] ■ KA5038 [10] Soft Material Gasket JR5038 [11] (Fibre)	
JD5431 ■ (x6) (SE) JA5077 ■ (x6)	JM7043 (x6) [3] (Fibre) →Eng.023559 JM5270 (x6) [29] (Rubber) Eng.032560 →		<input checked="" type="checkbox"/> NB928 ■ 105x130x12mm, FPM <input checked="" type="checkbox"/> NB929 ■ 120x140x13mm, FPM	HBS475 (x6) [8] ☉ M15x2x210mm (x4) HL5077 (x6) [14] ■ KA5038 [10] Soft Material Gasket JR5038 [11] (Fibre)	
JD5431 ■ (x6) (SE) JB179 ■ (x6)	JM7043 (x6) [3] (Fibre) →Eng.032559 JM5270 (x6) [29] (Rubber) Eng.032560 →	JJ495	<input checked="" type="checkbox"/> NB928 ■ 105x130x12mm, FPM <input checked="" type="checkbox"/> NB929 ■ 120x140x13mm, FPM	HBS475 (x6) [8] ☉ M15x2x210mm (x4) HL5077 (x6) [14] ■ KA5038 [10] Soft Material Gasket JR5038 [11] (Fibre)	
JD5431 ■ (x6) (SE) JB179 ■ (x6)	JM7043 (x6) [3] (Fibre) →Eng.794619 JM5270 (x6) [29] (Rubber) Eng.714620 →		<input checked="" type="checkbox"/> NB928 ■ 105x130x12mm, FPM <input checked="" type="checkbox"/> NB929 ■ 120x140x13mm, FPM	HBS475 (x6) [8] ☉ M15x2x210mm (x4) HL5077 (x6) [14] ■ KA5038 [10] Soft Material Gasket JR5038 [11] (Fibre)	
JA5077 ■ (x6)	JM5270 (x6) [29] (Rubber)		<input checked="" type="checkbox"/> NB928 ■ 105x130x12mm, FPM <input checked="" type="checkbox"/> NB929 ■ 120x140x13mm, FPM	HBS475 (x6) [8] ☉ M15x2x210mm (x4) HL5077 (x6) [14] ■ KA5038 [10] Soft Material Gasket JR5038 [11] (Fibre)	
JA5077 ■ (x6)	JM5270 (x6) [29] (Rubber)		<input checked="" type="checkbox"/> NB928 ■ 105x130x12mm, FPM <input checked="" type="checkbox"/> NB929 ■ 120x140x13mm, FPM	HBS475 (x6) [8] ☉ M15x2x210mm (x4) HL5077 (x6) [14] ■ KA5038 [10] Soft Material Gasket JR5038 [11] (Fibre)	
JA5077 ■ (x6)	JM5270 (x6) [29] (Rubber)		<input checked="" type="checkbox"/> NB928 ■ 105x130x12mm, FPM <input checked="" type="checkbox"/> NB929 ■ 120x140x13mm, FPM	HBS475 (x6) [8] ☉ M15x2x210mm (x4) HL5077 (x6) [14] ■ KA5038 [10] Soft Material Gasket JR5038 [11] (Fibre)	

MERCEDES-BENZ







cc

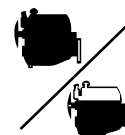

kW/PS

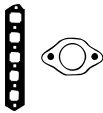

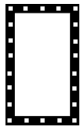
82	OM 457.960	11967	6	128.00	OM 457 LA/Euro 2/ Turbo Intercooled	315-260/ 428-354	AF5370 (SE) (x6) →Eng.85588		
83	OM 402.910/OM 402.911/ OM 402.914/OM 402.919/ OM 402.923/OM 402.927/ OM 402.928	12763	8	125.00	OM 402/V	176/240	AH5450 (Fibre) (x8)[21] BG850 (SE) (x8)	DG850 ○ (x8) →Eng.013 687 DG853 (x8) Eng.013 688 → DG854 ○ (x8) Eng.013 688 →	EX852 GG851
	OM 402.913/OM 402.917/ OM 402.921	12763	8	125.00	OM 402/V	177/240			
	OM 402.905/OM 402.906/ OM 402.907/OM 402.912/ OM 402.916/OM 402.924/ OM 402.925/OM 402.926	12763	8	125.00	OM 402/V	188/256			
84	OM 402.970/OM 402.971	12763	8	125.00	OM 402 LA/Euro 1/ Turbo Intercooled/V	280/381	AH5450 (Fibre) (x8)[21] BG850 (SE) (x8)	DG853 (x8) DG854 ○ (x8)	EX852
	OM 402.972	12763	8	125.00	OM 402 LA/Turbo Intercooled/V	280/381			
	OM 402.973	12763	8	125.00	OM 402 LA/Euro 1/ Turbo Intercooled/V	280/381			
	OM 402.974	12763	8	125.00	OM 402 LA/Euro 1/ Turbo Intercooled/V	280-295/ 381-401			
	OM 402.975/OM 402.977/ OM 402.978/OM 402.982/ OM 402.983/OM 402.984/ OM 402.985/OM 402.986/ OM 402.987/OM 402.989/ OM 402.990	12763	8	125.00	OM 402 LA/Euro 1/ Turbo Intercooled/V	280/381			
	OM 402.995	12763	8	125.00	OM 402 LA/Turbo Intercooled/V	280/381			
	OM 402.996	12763	8	125.00	OM 402 LA/Euro 1/ Turbo Intercooled/V	280/381			
85	OM 460.960	12816	6	128.00	OM 460 LA/Euro 3/ Turbo Intercooled	306/416			
	OM 460.950	12816	6	128.00	OM 460 HLA/Euro 3/ Turbo Intercooled	315-350/ 428-476			

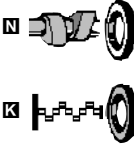
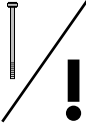
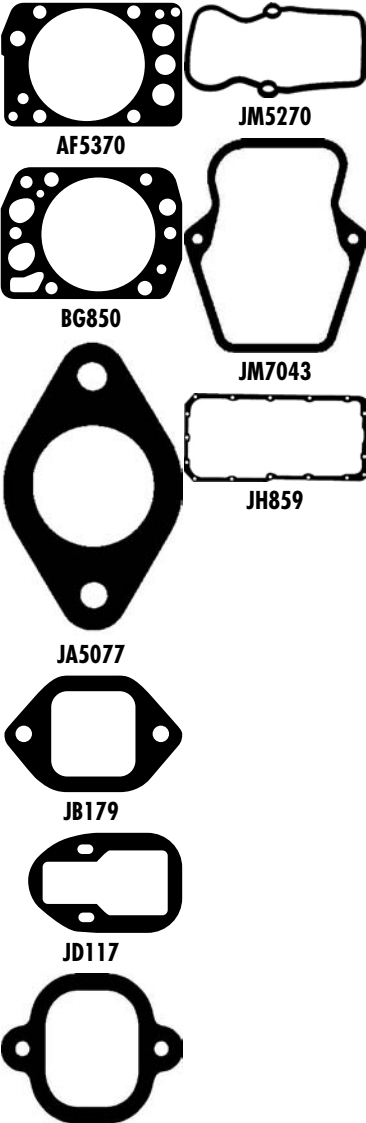
						
JA5077 (x6)	JM7043 (x6) [3] (Fibre) →Eng.023559 JM5270 (x6) [29] (Rubber) Eng.032560→			NB928 105x130x12mm, FPM NB929 120x140x13mm, FPM	HBS475 (x6) [8] ☉ M15x2x210mm (x4) HL5077 (x6) [14] ☒ KA5038 [10] Soft Material Gasket JR5038 [11] (Fibre)	AF5370 JM5270 BG850 JM7043 JH859
JD117 (x8) JB179 (x8)	JN977 (x8) Eng.013 686→	JH859	PB224 (x16) 12x16/20x15 860N (FPM)	NB928 105x130x12mm, FPM NB929 120x140x13mm, FPM	HBS226 (x8) [8] ☉ M15x2.0x168mm (x2) M15x2.0x144mm (x3) M15x2.0x109mm (x1) HT020 (x8) [14] ☒ HT021 (x8) [14] ☒ →Eng.535 118 HT018 (x8) [14] ☒ Eng.535 119→	JA5077 JB179 JD117 JD5431
JD117 (x8) JB179 (x8)	JN977 (x8)	JH859	PB224 (x16) 12x16/20x15 860N (FPM)	NB928 105x130x12mm, FPM NB929 120x140x13mm, FPM	HBS226 (x8) [8] ☉ M15x2.0x168mm (x2) M15x2.0x144mm (x3) M15x2.0x109mm (x1) HT018 (x8) [14] ☒	JA5077 JB179 JD117 JD5431
JD5431 (x6) (SE) JA5077 (x6)	JM5270 (x6) (Rubber)			NB928 105x130x12mm, FPM	HL5077 (x6) [14] ☒ KA5038 [10] Soft Material Gasket JR5038 [11] (Fibre)	JD5431

MERCEDES-BENZ



cc





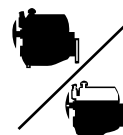





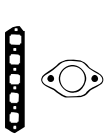

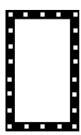

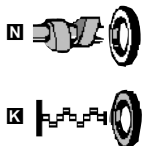
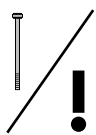
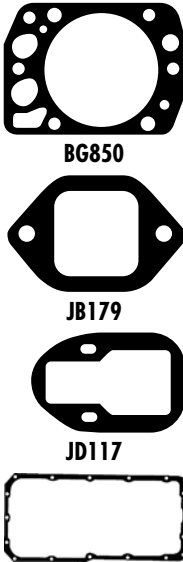

kW/PS



86

OM 422.909/OM 422.912/ OM 422.915/OM 422.920	14618	8	128.00	OM 422/V	184/250	AH5450 (Fibre) (x8)[21] BG850 (SE) (x8)	DG853 (x8) DG854 ○ (x8)	EX852
OM 422.905/OM 422.906/ OM 422.907/OM 422.908/ OM 422.910/OM 422.911/ OM 422.913/OM 422.914/ OM 422.916/OM 422.917	14618	8	128.00	OM 422/V	206/280			
OM 422.918/OM 422.919	14618	8	128.00	OM 422/V	206/280			
OM 422.921	14618	8	128.00	OM 422/V	206/280			
OM 422.922/OM 422.923	14618	8	128.00	OM 422/V	206/280			
OM 482.912/OM 482.930	14618	8	128.00	V	206/280			
OM 422.901/OM 422.951/ OM 422.952/OM 422.954/ OM 422.956/OM 422.957/ OM 422.958/OM 422.963	14618	8	128.00	OM 422 A/Turbo/V	243/330			
OM 482.940/OM 482.941	14618	8	128.00	Turbo/V	269/366			
OM 422.950/OM 422.953/ OM 422.955	14618	8	128.00	OM 422 LA/Turbo Intercooled/V	276/375			
OM 422.959	14618	8	128.00	OM 422 A/Turbo/V	276/375			

						
<p>JD117  (x8) JB179  (x8)</p>	<p>JN977 (x8)</p>	<p>JH859</p>	<p>PB224 (x16) 12x16/20x15 860N (FPM)</p>	<p> NB928  105x130x12mm, FPM  NB929  120x140x13mm, FPM</p>	<p>HB5226 (x8) [8]  M15x2.0x168mm (x2) M15x2.0x144mm (x3) M15x2.0x109mm (x1) HT021 (x8) [14]  →Eng.535 118 HT018 (x8) [14]  Eng.535 119→</p>	<p>BG850 JB179 JD117 JH859</p>



cc



kW/PS

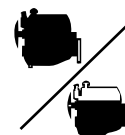

87

OM 440.940/OM 440.941/ OM 440.942/OM 440.943 OM 440.945 OM 440.949/OM 442.977/ OM 442.978/OM 442.979 OM 442.940 OM 442.942/OM 442.944	14618 14618 14618 14618 14618 14618	8 8 8 8 8 8	128.00 128.00 128.00 128.00 128.00 128.00	OM 442 A/Turbo/V OM 442 A/Euro 1/Turbo/V OM 442 A/Turbo/V OM 442 A/Turbo/V OM 442 A/Turbo/V OM 442 A/Turbo/V	250/340 250/340 250/340 260/354 260-269/ 354-366 260/354
OM 442.950/OM 442.952/ OM 442.958 OM 442.960/OM 442.961	14618 14618	8 8	128.00 128.00	OM 442 A/Turbo/V OM 442 A/Turbo/V	260-269/ 354-365 260-269/ 354-366
OM 442.962/OM 442.963/ OM 442.964/OM 442.965/ OM 442.966/OM 442.968 OM 442.970 OM 442.976	14618 14618	8 8	128.00 128.00	OM 442 A/Turbo/V OM 442 A/Turbo/V	260-269/ 354-366 260/354 260-269/ 354-366
OM 442.946/OM 442.957 OM 440.948/OM 442.941/ OM 442.943/OM 442.945/ OM 442.954/OM 442.955/ OM 442.959/OM 442.967/ OM 442.971/OM 442.972/ OM 442.973/OM 442.974/ OM 442.975	14618 14618	8 8	128.00 128.00	OM 442 A/Turbo/V OM 442 A/Turbo/V	266/366 269/366
OM 440.987/OM 440.988/ OM 440.989/OM 440.990 OM 446.924/OM 446.925/ OM 446.926/OM 446.927/ OM 446.928/OM 446.929/ OM 446.930/OM 446.931/ OM 446.934/OM 446.938 OM 440.970/OM 440.972	14618 14618	8 8	128.00 128.00	OM 442 LA/Euro 1/ Turbo Intercooled/V OM 442 LA/Euro 2/ Turbo Intercooled/V	280/381 280/381
OM 440.974 OM 440.978/OM 440.979/ OM 440.980/OM 440.984/ OM 440.985/OM 440.986/ OM 440.991 OM 442.951/OM 442.953/ OM 442.980 OM 442.995	14618 14618	8 8	128.00 128.00	OM 442 LA/Turbo Intercooled/V OM 442 LA/Euro 1/ Turbo Intercooled/V	320/435 320/435
OM 446.922	14618	8	128.00	OM 442 LA/Euro 1/ Turbo Intercooled/V	320/435
OM 446.923 OM 446.935/OM 446.936/ OM 446.939/OM 446.940/ OM 446.941/OM 446.942/ OM 446.943 OM 446.944 OM 446.948	14618 14618	8 8	128.00 128.00	OM 442 LA/Turbo Intercooled/V OM 442 LA/Euro 2/ Turbo Intercooled/V	320/435 320/435
OM 442.983 OM 442.982/OM 442.984/ OM 442.985/OM 442.992 OM 442.989/OM 442.991/ OM 442.993/OM 442.994 OM 440.971/OM 440.973/ OM 440.975/OM 440.976/ OM 440.981/OM 440.982/ OM 440.983/OM 442.996/ OM 442.997/OM 442.998/ OM 442.999	14618 14618	8 8	128.00 128.00	OM 442 LA/Turbo Intercooled/V OM 442 LA/Turbo Intercooled/V	329/447 353-362/ 480-492 362/492
OM 446.920/OM 446.932/ OM 446.933/OM 446.945/ OM 446.946 OM 446.947	14618 14618	8 8	128.00 128.00	OM 442 LA/Euro 1/ Turbo Intercooled/V OM 442 LA/Euro 2/ Turbo Intercooled/V OM 442 LA/Turbo Intercooled/V	370/503 390/530 390/530

AH5450 (Fibre) (x8)[21]
BG850 (SE) (x8)

DG853 (x8)
DG854 ○ (x8)

EX852

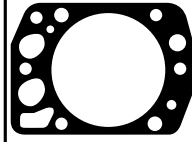
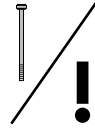
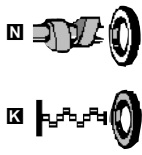
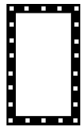
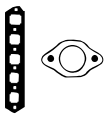

BG850



JB179

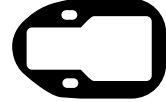

JD117

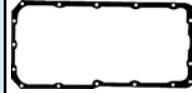

JH859

JD117 ■ (x8)
JB179 ■ (x8)

JN977 (x8)

JH859

PB224 (x16)
12x16/20x15
860N (FPM)

■ **NB928** ■ 105x130x12mm, FPM
■ **NB929** ■ 120x140x13mm, FPM

HBS226 (x8) [8] ©
M15x2.0x168mm (x2)
M15x2.0x144mm (x3)
M15x2.0x109mm (x1)
HT018 (x8) [14] ■

MERCEDES-BENZ



cc



kW/PS

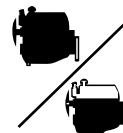

88

OM 440.905	15080	8	130.00	OM 442/Euro 1/V	191/260	AH5450 (Fibre) (x8)[21] BG850 (SE) (x8)	DG853 (x8) DG854 ○ (x8)	EX852
OM 442.905/OM 442.912	15080	8	130.00	OM 442/V	191/260			
OM 440.907	15080	8	130.00	OM 442/Euro 1/V	195/265			
OM 440.909/OM 442.914/ OM 442.920/OM 442.921/ OM 442.922/OM 442.931/ OM 442.932/OM 442.933/ OM 442.934/OM 442.935	15080	8	130.00	OM 442/V	195/265			
OM 440.906/OM 440.908	15080	8	130.00	OM 442/Euro 1/V	206/280			
OM 442.908/OM 442.909/ OM 442.923/OM 442.924	15080	8	130.00	OM 442/V	210/286			
OM 442.907	15080	8	130.00	OM 442/V	213/290			
OM 442.910	15080	8	130.00	OM 442/V	213-218/ 290-296			
OM 442.913	15080	8	130.00	OM 442/V	213/290			
OM 442.918/OM 442.919	15080	8	130.00	OM 442/V	213-218/ 290-296			
OM 442.925/OM 442.926/ OM 442.927/OM 442.928/ OM 442.929/OM 442.930	15080	8	130.00	OM 442/V	213/290			
OM 442.939	15080	8	130.00	OM 442/V	213-218/ 290-296			
OM 440.910/OM 440.911/ OM 440.912	15080	8	130.00	OM 442/Euro 1/V	218/296			
OM 442.906/OM 442.911/ OM 442.915/OM 442.916/ OM 442.917	15080	8	130.00	OM 442/V	218/296			

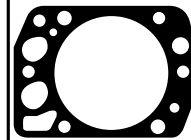
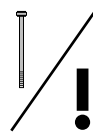
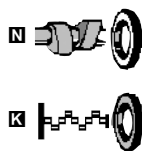
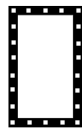
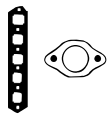

BG850



JB179



JD117

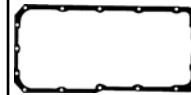

JH859

JD117 ■ (x8)
JB179 ■ (x8)

JN977 (x8)

JH859

PB224 (x16)
12x16/20x15
860N (FPM)

■ **NB928** ■ 105x130x12mm, FPM
■ **NB929** ■ 120x140x13mm, FPM

HBS226 (x8) [8] ©
M15x2.0x168mm (x2)
M15x2.0x144mm (x3)
M15x2.0x109mm (x1)
HT021 (x8) [14] ■
→Eng.535 118
HT018 (x8) [14] ■
Eng.535 119→



cc



kW/PS

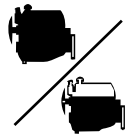

89

OM 542.960/OM 542.964 OM 542.948	15928 15928	8 8	130.00 130.00	Euro 5/Turbo Intercooled/V OM 502 LA/Euro 3/ Turbo Intercooled/V	320-370/ 435-503
OM 942.990	15928	8	130.00	OM 502 LA/Euro 2/ Turbo Intercooled/V	330-448/ 570-609
OM 942.900/OM 942.910/ OM 942.911/OM 942.912/ OM 942.960	15928	8	130.00	OM 502 LA/Euro 2/ Turbo Intercooled/V	350/470
OM 542.921	15928	8	130.00	OM 502 LA/Turbo Intercooled/V	350/476
OM 542.925	15928	8	130.00	OM 502 LA/Euro 2/ Turbo Intercooled/V	350/476
OM 542.940/OM 542.941	15928	8	130.00	OM 502 LA/Euro 3/ Turbo Intercooled/V	350/476
OM 522.942/OM 522.943	15928	8	130.00	OM 502 LA/Euro 2/ Turbo Intercooled/V	362/496
OM 542.940	15928	8	130.00	OM 502 LA/Euro 3/ Turbo Intercooled/V	370-375/ 503-510
OM 542.941	15928	8	130.00	OM 502 LA/Euro 3/ Turbo Intercooled/V	370/503
OM 942.967	15928	8	130.00	OM 502 LA/Euro 2/ Turbo Intercooled/V	370-380/ 503-517
OM 542.961	15928	8	130.00	Euro 5/Turbo Intercooled/V	375/510
OM 542.920/OM 542.926	15928	8	130.00	OM 502 LA/Turbo Intercooled/V	390/530
OM 542.942/OM 542.943	15928	8	130.00	OM 502 LA/Euro 3/ Turbo Intercooled/V	390-395/ 530-537
OM 542.947	15928	8	130.00	OM 502 LA/Turbo Intercooled/V	390-420/ 530-571
OM 942.970	15928	8	130.00	OM 502 LA/Euro 2/ Turbo Intercooled/V	390/570
OM 942.925	15928	8	130.00	OM 502 LA/Euro 2/ Turbo Intercooled/V	400/544
OM 542.962/OM 542.963	15928	8	130.00	OM 502 LA/Euro 5/ Turbo Intercooled/V	405/551
OM 522.941	15928	8	130.00	OM 502 LA/Euro 2/ Turbo Intercooled/V	413/562
OM 942.930/OM 942.980	15928	8	130.00	OM 502 LA/Euro 2/ Turbo Intercooled/V	420/570
OM 522.940	15928	8	130.00	OM 502 LA/Euro 2/ Turbo Intercooled/V	420/571
OM 542.922/OM 542.923/ OM 542.924	15928	8	130.00	OM 502 LA/Turbo Intercooled/V	420/571
OM 542.944/OM 542.945	15928	8	130.00	OM 502 LA/Euro 3/ Turbo Intercooled/V	420-425/ 571-578
OM 542.956/OM 542.957	15928	8	130.00	OM 502 LA/Euro 3/ Turbo Intercooled/V	448/609
OM 522.950	15928	8	130.00	OM 502 LA/Euro 2/ Turbo Intercooled/V	530/721

BZ140 (SE) (x8)

→Eng.357748

AG8280 (SE) (x8)

Eng.357749→

DZ140 (x8)

→Eng.084423

DZ141 (x8)

Eng.084424→

→Eng.155295

DZ142 (x8)

Eng.155296→

→Eng.357748

DZ143 (x8)

Eng.357749→

EC370

→Eng.012090

EC522

Eng.012091→

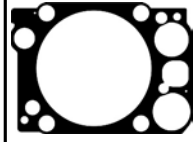
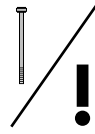
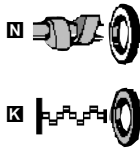
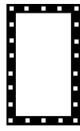
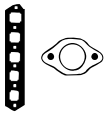

BZ140

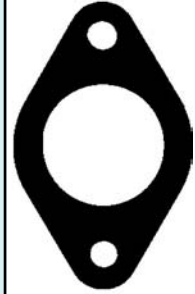

JA5077

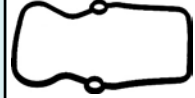

JM5270

JD5086 (x8)
JA5077 (x8)

JM5186 (x8)
(Rubber)
→Eng.084423
JM5187 (x8)
(Rubber)
Eng.084424→
→Eng.155295
JM5270 (x8)
(Rubber)
Eng.155296→

JH5168
Soft
Material
Gasket
→Eng.012090
JH5073
(Rubber)
Eng.012091→

NB928 105x130x12mm, FPM
NB929 120x140x13mm, FPM

HBS350 (x8) [8] ©
M18x2.0x210mm (x4)
HT5038 (x8) [14]

MERCEDES-BENZ



cc



kW/PS

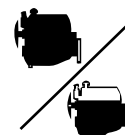

90	OM 403.906	15950	10	125.00	OM 403/V	184/250	AH5450 (Fibre) (x10)[21] BG850 (SE) (x10)	DG850 ○ (x10) →Eng.022 607 DG853 (x10) Eng.022 608→ DG854 ○ (x10) Eng.022 608→	
	OM 403.918/OM 403.931/ OM 403.932	15950	10	125.00	OM 403/V	235/320			
	OM 403.905/OM 403.915/ OM 403.916/OM 403.917/ OM 403.919/OM 403.930/ OM 403.934/OM 403.935	15950	10	125.00	OM 403/V	236/320			
	OM 403.933	15950	10	125.00	OM 403/V	261/355			
91	OM 443.940	18270	10	128.00	OM 443 A/Turbo/V	340/462	AH5450 (Fibre) (x10)[21] BG850 (SE) (x10)	DG853 (x10) DG854 ○ (x10)	
	OM 443.980	18270	10	128.00	OM 443 LA/Turbo Intercooled/V	412/560			
92	OM 423.905/OM 423.906/ OM 423.907/OM 423.908/ OM 423.909	18273	10	128.00	OM 423/V	261/355	AH5450 (Fibre) (x10)[21] BG850 (SE) (x10)	DG853 (x10) DG854 ○ (x10)	
	OM 423.950/OM 423.951	18273	10	128.00	OM 423 LA/Turbo Intercooled/V	368/500			
93	OM 443.905/OM 443.906/ OM 443.908/OM 443.909	18848	10	130.00	OM 443/V	271/369	AH5450 (Fibre) (x10)[21] BG850 (SE) (x10)	DG853 (x10) DG854 ○ (x10)	
94	OM 404	20911	12	125.00	V	184/236/ 250/320	AH5450 (Fibre) (x12)[21] BG850 (SE) (x12)	DG850 ○ (x12) →Eng.000 234 DG853 (x12) Eng.000 235→ DG854 ○ (x12) Eng.000 235→	
	OM 404 A	20911	12	125.00	Turbo/V	386/525			
95	OM 444 A	21927	12	128.00	Turbo/V	390/530	AH5450 (Fibre) (x12)[21] BG850 (SE) (x12)	DG853 (x12) DG854 ○ (x12)	
	OM 444 LA	21927	12	128.00	Turbo Intercooled/V	478/610/ 530/830			
96	OM 424.900	21930	12	128.00	OM 424/V	309/420	AH5450 (Fibre) (x12)[21] BG850 (SE) (x12)	DG853 (x12) DG854 ○ (x12)	GG85F
	OM 424.901/OM 424.901-510	21930	12	128.00	OM 424 LA/Turbo Intercooled/V	441/600			
97	OM 444	22618	12	130.00	V		AH5450 (Fibre) (x12)[21] BG850 (SE) (x12)	DG853 (x12) DG854 ○ (x12)	

						 BG850 JB179 JD117 JH858 JJ489
JD117 ■ (x10) JB179 ■ (x10)	JN977 (x10) Eng.022 608 →	JH858	PB224 (x20) 12x16/20x15 860N (FPM)	<input checked="" type="checkbox"/> NB928 ■ 105x130x12mm, FPM <input checked="" type="checkbox"/> NB929 ■ 120x140x13mm, FPM	HBS226 (x10)[8] ☉ M15x2.0x168mm (x2) M15x2.0x144mm (x3) M15x2.0x109mm (x1) HT020 (x10)[14] ■ HT021 (x10)[14] ■ →Eng.535 118 HT018 (x10)[14] ■ Eng.535 119 →	
JD117 ■ (x10) JB179 ■ (x10)	JN977 (x10)	JH858	PB224 (x20) 12x16/20x15 860N (FPM)	<input checked="" type="checkbox"/> NB928 ■ 105x130x12mm, FPM <input checked="" type="checkbox"/> NB929 ■ 120x140x13mm, FPM	HBS226 (x10)[8] ☉ M15x2.0x168mm (x2) M15x2.0x144mm (x3) M15x2.0x109mm (x1) HT018 (x10)[14] ■	
JD117 ■ (x10) JB179 ■ (x10)	JN977 (x10)	JH858	PB224 (x20) 12x16/20x15 860N (FPM)	<input checked="" type="checkbox"/> NB928 ■ 105x130x12mm, FPM <input checked="" type="checkbox"/> NB929 ■ 120x140x13mm, FPM	HBS226 (x10)[8] ☉ M15x2.0x168mm (x2) M15x2.0x144mm (x3) M15x2.0x109mm (x1) HT021 (x10)[14] ■ →Eng.535 118 HT018 (x10)[14] ■ Eng.535 119 →	
JD117 ■ (x10) JB179 ■ (x10)	JN977 (x10)	JH858	PB224 (x20) 12x16/20x15 860N (FPM)	<input checked="" type="checkbox"/> NB928 ■ 105x130x12mm, FPM <input checked="" type="checkbox"/> NB929 ■ 120x140x13mm, FPM	HBS226 (x10)[8] ☉ M15x2.0x168mm (x2) M15x2.0x144mm (x3) M15x2.0x109mm (x1) HT018 (x10)[14] ■	
JD117 ■ (x12) JB179 ■ (x12)	JN977 (x12) Eng.000 235 →	JJ489	PB224 (x24) 12x16/20x15 860N (FPM)	<input checked="" type="checkbox"/> NB928 ■ 105x130x12mm, FPM <input checked="" type="checkbox"/> NB929 ■ 120x140x13mm, FPM	HBS226 (x12)[8] ☉ M15x2.0x168mm (x2) M15x2.0x144mm (x3) M15x2.0x109mm (x1) HT020 (x12)[14] ■	
JD117 ■ (x12) JB179 ■ (x12)	JN977 (x12)		PB224 (x24) 12x16/20x15 860N (FPM)	<input checked="" type="checkbox"/> NB928 ■ 105x130x12mm, FPM <input checked="" type="checkbox"/> NB929 ■ 120x140x13mm, FPM	HBS226 (x12)[8] ☉ M15x2.0x168mm (x2) M15x2.0x144mm (x3) M15x2.0x109mm (x1) HT018 (x12)[14] ■	
JD117 ■ (x12) JB179 ■ (x12)	JN977 (x12)	JJ489	PB224 (x24) 12x16/20x15 860N (FPM)	<input checked="" type="checkbox"/> NB928 ■ 105x130x12mm, FPM <input checked="" type="checkbox"/> NB929 ■ 120x140x13mm, FPM	HBS226 (x12)[8] ☉ M15x2.0x168mm (x2) M15x2.0x144mm (x3) M15x2.0x109mm (x1) HT021 (x12)[14] ■ →Eng.535 118 HT018 (x12)[14] ■ Eng.535 119 →	
JD117 ■ (x12) JB179 ■ (x12)	JN977 (x12)		PB224 (x24) 12x16/20x15 860N (FPM)	<input checked="" type="checkbox"/> NB928 ■ 105x130x12mm, FPM <input checked="" type="checkbox"/> NB929 ■ 120x140x13mm, FPM	HBS226 (x12)[8] ☉ M15x2.0x168mm (x2) M15x2.0x144mm (x3) M15x2.0x109mm (x1) HT018 (x12)[14] ■	

MITSUBISHI



cc



kW/PS

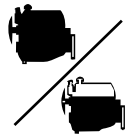

1	6 DS 5	4978	6	98.00			BJ990 (Fibre)		
2	6 DS 7	5430	6	98.00			BJ990 (Fibre)		
3	6 D 10	5974	6	105.00			BK890 (Fibre)		GK890 [7]
4	6 D 14 T	6557	6	110.00	Turbo		BK560 (Graphite)	DK562 03/82 →	
5	6 D 15 T	6557	6	110.00			B5040 (Fibre) 01/86 →		
6	6D14	6557	6	110.00		118/160	BK560 (Graphite)	DK560 ○ 01/76 → 12/82	GK560 01/76 → 12/82
7	6 D 15	6919	6	113.00			B5040 (Fibre)		GS040 [36]
8	6D16	7545	6	118.00		120-96/ 163-131			
9	6 D 22 A 6 D 22 T	11149 11149	6 6	130.00 130.00			B5640 (MLS) (x6)		GS641
10	8 DC 8	14886	8	135.00	Turbo				
11	8 DC 9	16031	8	135.00			B5930 (Fibre) (x2) → 12/83		

		JJ242		<input checked="" type="checkbox"/> NJ258 55x78x12mm, NBR <input checked="" type="checkbox"/> NJ257 105x125x11.7mm, MVQ		 BJ990	
		JJ242		<input checked="" type="checkbox"/> NJ258 55x78x12mm, NBR <input checked="" type="checkbox"/> NJ257 105x125x11.7mm, MVQ <input checked="" type="checkbox"/> NJ497 100x123x12.5mm, MVQ		 BK560	
JC321 (x2)	JN429	JJ178		<input checked="" type="checkbox"/> NJ496 72x94x12mm, NBR <input checked="" type="checkbox"/> NJ257 105x125x11.7mm, MVQ		 BK890	
JC808 (x6)	JN429 03/82→02/84	JJ178 03/82→02/84	PA425 (x12)	<input checked="" type="checkbox"/> NJ496 72x94x12mm, NBR <input checked="" type="checkbox"/> NJ497 100x123x12.5mm, MVQ 03/82→02/84 <input checked="" type="checkbox"/> NJ910 107x115.8x17.5mm, MVQ 03/84→		 BS040	
JC808 (x6) 01/86→	JN429 01/86→		PA425 (x12) 01/86→	<input checked="" type="checkbox"/> NJ496 72x94x12mm, NBR <input checked="" type="checkbox"/> NJ497 100x123x12.5mm, MVQ 01/86→ <input checked="" type="checkbox"/> NJ910 107x115.8x17.5mm, MVQ 01/86→		 BS640	
JC321 (x2)	JN429	JJ178	PA525 (x12) 01/76→12/82	<input checked="" type="checkbox"/> NJ496 72x94x12mm, NBR <input checked="" type="checkbox"/> NJ257 105x125x11.7mm, MVQ <input checked="" type="checkbox"/> NJ497 100x123x12.5mm, MVQ 01/76→12/82		 BS930	
JC808 (x6)	JN429		PA525 (x12)	<input checked="" type="checkbox"/> NJ496 72x94x12mm, NBR <input checked="" type="checkbox"/> NJ497 100x123x12.5mm, MVQ			
				<input checked="" type="checkbox"/> NJ496 72x94x12mm, NBR <input checked="" type="checkbox"/> NJ257 105x125x11.7mm, MVQ			
				<input checked="" type="checkbox"/> NJ980 135x155.5x15mm, MVQ			
				<input checked="" type="checkbox"/> NJ490 85x110x13mm, NBR		 JJ178	



cc





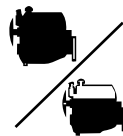



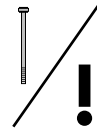
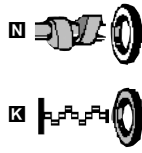
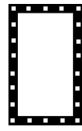
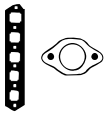

kW/PS



1	D 226 B-2	2080	2	105.00		32/44	AH5490 (Fibre), 1.4mm AH5460 (Fibre), 1,25mm (x2)		
2	D 226 B-3	3120	3	105.00		33-55/ 45-75	AH5490 (Fibre), 1.4mm (x3) AH5460 (Fibre), 1,25mm (x3)		
3	D 227-4	3768	4	100.00		46-61/ 63-83	AH5420 (Fibre), 0.85mm (x4) AG7340 (Fibre), 1.4mm (x4)		
4	KD 110,5-6	4010	6	90.00		53/72			
5	D 226 B-4	4160	4	105.00		60-74/ 86-100	AH5490 (Fibre), 1.4mm (x4)		
	TD 226 B-4	4160	4	105.00	Turbo	76/103			
6	D 308-6	4470	6	95.00		68/92			
7	D 325-6	5100	6	95.00		63-75/ 86-102			
	D 225-6	5100	6	95.00		75/102			
8	D 327-6	5654	6	100.00		68-82/ 92-112			
	D 227-6	5654	6	100.00		71-91/ 97-124			
10	D 226-6	6234	6	105.00		74-96/ 101-131			
	TD 226-6	6234	6	105.00	Turbo	107-125/ 146-170			
11	D 226 B-6	6234	6	105.00		77-88/ 105-120	AH5490 (Fibre), 1.4mm (x6)		



		JH5172			
		JH5172			
		JH5172			
		JH5172			
		JH5172			
		JH5172			

		cc			9			cc			9
604.021	Diesel	6456	4	122.00	26						
604.030/604.031/604.034/ 604.035/604.041	Diesel	6872	4	125.00	28						
8045.02	Diesel	3455	4	100.00	2						
8045.04	Diesel	3666	4	103.00	4						
8045.05	Diesel	3908	4	104.00	6						
8045.06	Diesel	3613	4	100.00	3						
8045.25	Diesel	3908	4	104.00	6						
8055.04	Diesel	4583	5	103.00	12						
8055.05	Diesel	4882	5	104.00	13						
8061 L/8061L	Diesel	5499	6	103.00	21						
8061.05	Diesel	5419	6	104.00	19						
8065.02	Diesel	5184	6	100.00	17						
8065.04	Diesel	5499	6	103.00	22						
8065.05	Diesel	5861	6	104.00	24						
8065.06	Diesel	5420	6	100.00	20						
8065.24	Diesel	5499	6	103.00	23						
8065.25	Diesel	5863	6	104.00	25						
8081.22	Diesel	17174	8	145.00	37						
8210.22	Diesel	13798	6	137.00	35						
8211.22	Diesel	13798	6	137.00	36						
8281.02	Diesel	17174	8	145.00	38						
8361.05	Diesel	8102	6	115.00	1						
8365.05.500	Diesel	8102	6	115.00	31						
8365.05.590	Diesel	8102	6	115.00	32						
8365.25.500/8365.25.500/ 502	Diesel	8102	6	115.00	33						
8365.25.501/8365.25.501/ 503/533/8365.25.503	Diesel	8102	6	115.00	31						
8365.25.590	Diesel	8102	6	115.00	32						
8460.21/8460.21.002/ 8460.21.042/8460.21.102/ 8460.21.106/8460.21.708/ 8460.21.710	Diesel	9500	6	120.00	34						
C03	Diesel	4941	4	110.00	14						
C03/20/21/41	Diesel	4562	4	110.00	11						
C03D/C55/C02	Diesel	4397	4	108.00	8						
CN3	Diesel	3706	3	110.00	5						
C0130/C020/60/C02D/C03D	Diesel	4397	4	108.00	9						
C01D	Diesel	4156	4	105.00	7						
C03/C03C	Diesel	4941	4	110.00	15						
C03-130T	Diesel	5401	4	115.00	18						
CP 3/100	Diesel	7412	6	110.00	29						
Genesis	Diesel	4400	4	111.77	10						
Genesis	Diesel	5000	4	111.77	16						
Genesis	Diesel	6600	6	111.77	27						
Genesis	Diesel	7500	6	111.77	30						



21

9



21

9

45		7	180.90	33
50		7	180.90 DT	33
55 HP	→12/71	26	512	7
60 HP	→12/71	26	513	9
65.46	01/84→	3	516	9
65.56	01/84→	3	600 C	→12/72 2
65.66	01/84→	3	600 R	→12/72 2
65.88	01/84→	3	605 C	→12/72 2
65.90	01/84→	3	605 CM	01/72→ 2
65.93	01/84→	3	605 CS	→12/72 2
65.94	01/84→	3	605 R	→12/72 2
70 C	→12/71	28	615	→12/72 9
70 CI	→12/71	28	640	2
70.56	01/84→	3	650 S	01/69→ 5
70.65	01/84→	3	655	01/69→ 5
70.66	01/84→	3	655 C	5
70.75	01/84→	3	665	2
70.76	01/84→	3	666	2
70.86	01/84→	3	670	2
70.88	01/84→	3	680	01/72→ 2
70.90	01/84→	3	680 DT	2
72.93	01/84→	3	715	→12/72 9
72.94	01/84→	3	750	01/72→ 11
80 C	01/72→	18	750 Special	01/75→ 14
80 CA	→12/71	28	765 C	01/82→ 4
80 R	→12/71	28	766	01/82→ 4
80 R	01/72→	18	780	01/76→ 4
80.55	01/84→	6	805 C	11
80.65	01/84→	6	805 C	01/75→ 14
80.66	01/84→	6	850	01/72→ 11
80.75 C	01/84→	6	850 DTS	→12/72 14
80.76	01/84→	6	850 S	11
80.88	01/84→	6	850 Super	→12/72 14
80.90	01/84→	6	855	01/76→ 4
82.85	01/84→	6	880	11
82.86	01/84→	6	880	01/79→ 14
82.93	01/84→	6	880.5	01/81→ 12
82.94	01/84→	6	955 C	01/81→ 12
85.55	01/84→	6	980	01/79→ 17
85.90		6	980 DT	01/79→ 17
85.90	01/84→	6	1000	01/71→ 17
85.90 DT		6	1000 Special	01/78→ 22
88 C		6	1180	24
88.85		6	1280	01/80→ 23
88.93		6	1300	01/73→ 29
88.94		6	1300 DT	01/73→ 29
90 C	01/75→	18	1300 Super	01/73→ 29
90.90		12	1355 C	32
90.90	01/84→	13	1380	01/80→ 23
95.55	01/84→	13	1580	01/80→ 31
100		20	1580 T	31
100 C	01/71→	29	1880 DT	33
100 DT	01/71→	17	3350 Laverda	17
100.80	01/84→	20	3450	17
100.90		20	5640	11/91→ 10
110		22	6640	11/91→ 16
110 S		22	7740	11/91→ 16
110.90		22	7840	11/91→ 27
110.90	01/81→	24	8240	11/91→ 30
115.90		22	8340	11/91→ 30
115.90	01/81→	24	A65 Agrifull	01/84→ 3
120 C	01/81→	29	A70C Agrifull	01/84→ 3
130.90		22	A70F Agrifull	01/84→ 3
130.90		24	A70L Agrifull	01/84→ 3
130.90 Turbo	01/83→	25	A80.70 E Agrifull	01/72→ 2
140 Agrifull		25	A80.70 M Agrifull	2
140.90		22	A80.76 E Agrifull	01/76→ 4
140.90		24	A80C Agrifull	01/84→ 6
140.90 Turbo	01/83→	25	A80F Agrifull	01/84→ 6
150 C	01/81→	29	A90 Agrifull	6
160.55 C	01/83→	32	A90 Agrifull	01/84→ 13
160.90 DT		31	A100 Agrifull	01/84→ 20
180.55		33	A110 Agrifull	01/81→ 24



21

9



21

9

A140 Agrifull	01/83→	25
AD7	→12/71	28
DI 50		8
DI 60		15
DI 60		8
DI 65		15
DIM 30		2
DIM 35		2
F100		20
F100		24
F110		24
F115		24
F120		24
F130		25
F140		25
FA200		34
FD208		34
FL8	→12/71	28
FR8	→12/71	28
FR206		34
FR220		34
Industrial		21
Industrial		36
Industrial		37
Industrial		38
Industrial		4
Laverda 3350		19
Laverda 3400		19
Laverda 3500		19
Laverda 3700		1
Laverda M100		15
Laverda M100AL		15
M132		17
M132 Laverda		17
MX300		35
TX66		34

NEW HOLLAND









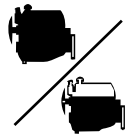



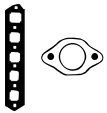

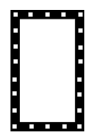

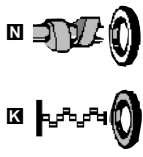
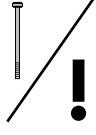











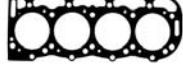

cc

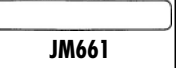
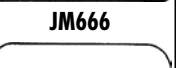
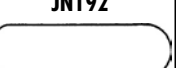
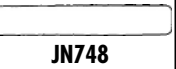
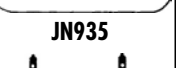
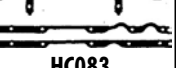
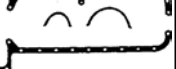

kW/PS

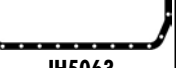

1	8361.05	8102	6	115.00			AY020 (Fibre)		GD846 ▲○ [7]
2	8045.02	3455	4	100.00			AN460 (Fibre), 1.35mm AY650 (Fibre), 1.58mm	CN465 ■○	FN465 ○
3	8045.06	3613	4	100.00			AN460 (Fibre), 1.35mm AY650 (Fibre), 1.58mm	CN467 ■○	FN469 ○
4	8045.04	3666	4	103.00			BV520 (Fibre), 1.35mm BS340 (Fibre), 1.58mm	DH142 ■○	GH142 ○
5	CN3	3706	3	110.00			AN480 (Fibre)	CN481 ■○	FN481 ○
6	8045.05 8045.25	3908 3908	4 4	104.00 104.00	Turbo		BV520 (Fibre), 1.35mm BS340 (Fibre), 1.58mm	CY010 ○	FY010 ○
7	CO1D	4156	4	105.00			AX070 (Fibre)		
8	CO3D/C55/CO2	4397	4	108.00			AL610 (Fibre)		
9	CO130/CO20/60/CO2D/CO3D	4397	4	108.00			AL610 (Fibre)	CN170 ▲■○	FN170 ■○
10	Genesis	4400	4	111.77	5640		BX540 (Fibre)	DX540 ■	
11	CO3/20/21/41	4562	4	110.00			AN010 (Fibre)	CN013 ■○	FN013 ○
12	8055.04	4583	5	103.00			BP480 (Fibre)	DP320 ○	GP320 ○
13	8055.05	4882	5	104.00			BP480 (Fibre)	DP320 ○	GP320 ○
14	CO3	4941	4	110.00			AN010 (Fibre)	CN013 ■○	FN013 ○
15	CO3/CO3C	4941	4	110.00			AN010 (Fibre)		
16	Genesis Genesis	5000 5000	4 4	111.77 111.77	6640 7740/Turbo		BX540 (Fibre)	DX540 ■	
17	8065.02	5184	6	100.00			AN470 (Fibre)		FN475 ○
18	CO3-130T	5401	4	115.00			AX850 (Fibre)	CX850 ○	FX850 ○
19	8061.05	5419	6	104.00			BV710 (Fibre), 1.35mm BW160 (Fibre), 1.58mm	DV712 ■○	GV715 ○
20	8065.06	5420	6	100.00			AN470 (Fibre)		FN477 ○
21	8061 L/8061L	5499	6	103.00			BV710 (Fibre), 1.35mm		GV714 ▲■○
22	8065.04	5499	6	103.00			BV710 (Fibre), 1.35mm	DP490 ■○	GH152 ○

     							
JC732 ■ (x2) JD229 ■ (x4)	JN192 (ACM)	HC335 ■ JJ416			KA499 [10] LR948 [10] LA646 [11]	 AL610  AN010  AN460, AY650  AN470  AN480  AX070  AX850  AY020  BP480  BV520, BS340  BV710, BW160  BX540  JA866  JC732  JD229	 JE479  JM541  JM661  JM666  JN192  JN312  JN748  JN935  HC083  HC335  HC397  HC398  JH5063  JJ416
JC732 ■ (x2) JD229 ■ (x4)	JN192 (ACM)	HC335 ■ JJ416			KA499 [10] LR948 [10] LA646 [11]		
JC732 ■ (x2) JD229 ■ (x4)	JN192 (ACM)	HC335 ■ JJ416			KA499 [10] LR948 [10] LA646 [11]		
JC732 ■ (x2) JD229 ■ (x4)	JN192 (ACM) JN935 (Viton)	HC335 ■ JJ416			KA499 [10] LR948 [10] LA646 [11]		
					KK195 [14] ■ KK196 [14] ■		
					KK180 [14] ■ KK195 [14] ■ KK196 [14] ■ KK972 [14] ■		
	JM541	JH5063 2.80mm (Cork)					
JA866 ■ (x3)	JM666	HC083 ■ HC397 ■	PA159		KK195 [14] ■ KK196 [14] ■ KL351 [14] ■		
JC732 ■ (x3) JD229 ■ (x5)					KA499 [10] LR948 [10]		
JC732 ■ (x3) JD229 ■ (x5)					KA499 [10] LR948 [10]		
JA866 ■ (x3)	JM666	HC083 ■ HC397 ■	PA159		KK195 [14] ■ KK196 [14] ■ KL351 [14] ■		
JA866 ■ (x4) JE479							
	JM541	JH5063 2.80mm (Cork)					
JC732 ■ (x3) JD229 ■ (x6)	JM661 (NBR) JN748 (Viton)	HC398 ■			KA499 [10] LR948 [10]		
	JM666 JN312						
JC732 ■ (x3) JD229 ■ (x6)	JM661 (NBR) JN748 (Viton)	HC398 ■					
JC732 ■ (x3) JD229 ■ (x6)	JM661 (NBR) JN748 (Viton)	HC398 ■		■ NB929 ■ 120x140x13mm, FPM	KA499 [10] LR948 [10]		
JC732 ■ (x3) JD229 ■ (x6)	JM661 (NBR) JN748 (Viton)	HC398 ■			KA499 [10] LA646 [11]		

NEW HOLLAND



cc



kW/PS

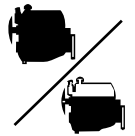

23	8065.24	5499	6	103.00	/Turbo		BV710 (Fibre), 1.35mm	DH152 ○	GH153 ○
24	8065.05	5861	6	104.00			BV710 (Fibre), 1.35mm		GP490 ○
25	8065.25	5863	6	104.00	Turbo	94-110/ 128-150	BV710 (Fibre), 1.35mm	DV712 ■○	GV715 ○
26	604.021	6456	4	122.00			AL570 (Fibre)	CL542 ▲■○	
27	Genesis	6600	6	111.77	7840		AA5150 (Graphite), 1.30mm	DV971 ■	
28	604.030/604.031/604.034/ 604.035/604.041	6872	4	125.00			AL590 (Fibre)	CL542 ▲■○	FL581 ▲■○
29	CP 3/100	7412	6	110.00			AN340 (Fibre)	CN341 ■○	FN347 ○
30	Genesis	7500	6	111.77	8240,8340		AA5150 (Graphite), 1.30mm	DV971 ■	
31	8365.05.500 8365.25.501/8365.25.501/ 503/533/8365.25.503	8102 8102	6 6	115.00 115.00	Turbo		AY020 (Fibre)	DD844 ■○	GD848 ○
32	8365.05.590 8365.25.590	8102 8102	6 6	115.00 115.00	Turbo		AY020 (Fibre)	DD844 ■○	
33	8365.25.500/8365.25.500/ 502	8102	6	115.00	Turbo		AY020 (Fibre)	DD844 ■○	GD847 ○
34	8460.21/8460.21.002/ 8460.21.042/8460.21.102/ 8460.21.106/8460.21.708/ 8460.21.710	9500	6	120.00	Turbo		BS350 (Fibre) (x2)	DS350 ▲○	GS350 ▲○
35	8210.22	13798	6	137.00	Turbo		BL991 (SE) (x2)	DL992 ▲■○	GL992 ▲○
36	8211.22	13798	6	137.00			BL991 (SE) (x2)	DL992 ▲■○	GL992 ▲○
37	8081.22	17174	8	145.00	Turbo/V		BH790 (SE), 1.20mm (x8)		GH796 ○
38	8281.02	17174	8	145.00	V		BH790 (SE), 1.20mm (x8)		GH797 ○

JC732 (x3) JD229 (x6)	JM661 (NBR) JN748 (Viton)	HC398			KA499 [10] LR948 [10]
JD229 (x6)	JM661 (NBR) JN748 (Viton)	HC398	NB929 120x140x13mm, FPM		KA499 [10] LR948 [10]
JC732 (x3) JD229 (x6)	JM661 (NBR) JN748 (Viton)	HC398			KA499 [10] LR948 [10]
JA866 (x2)	JN222 (x2) JM667				KK195 [14] KK196 [14]
JC234 (x2) JC603	JN222 (x2)				
JC234 (x2) JC603	JN222 (x2)				
JC234 (x2) JC603	JN222 (x2)				
	JN745 (x2)	JJ191			HT031 [14] HT032 [14] HT033 [14] HT034 [14] JS075 [11] JS077 [11] JS078 [11] LS083 [11]
JC874 (x2) JC873 (x2)	JN796 (x2)	JJ518 (Cork)			
JC874 (x2) JC873 (x2)	JN796 (x2)	JJ518 (Cork)			
	JN310				
	JN310 JN311				

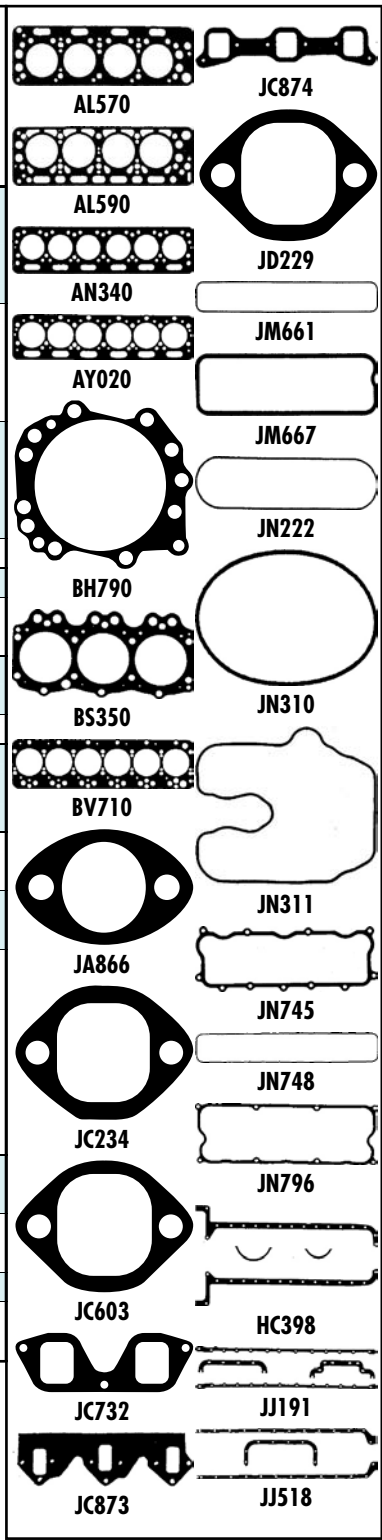

NISSAN



cc



kW/PS

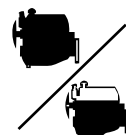

1	ED6/FD6	5654	6	100.00			BJ390 (Fibre)		
2	FE6-B	6925	6	108.00		125/170	AE5940 (MLS)		
3	PD6	10308	6	125.00			AE5700 (SE) (x2)	DE910 ■	GE911
4	PE6T	11670	6	133.00	Turbo		AE5710 (SE) (x2)	CE5711	FE5711
5	RD8	14313	8	135.00			BK530 (Fibre)		GK530
6	RD10	17892	10	135.00					

			PA192 (x12)	☒ NJ228 ☒ 105x135x13mm, MVQ	
		JJ220			
JC199 ☒ (x6) JC204 ☒ (x6) ☉ JE107 (x2)			PA189 (x12)	☒ NJ230 ☒ 126x150x14mm, MVQ	
JC291 ☒ (x6) ☉ JE107 (x2)			PA189 (x12)	☒ NJ230 ☒ 126x150x14mm, MVQ	
JC292 ☒ ☉ JE107 (x2)	JN475 (x2)		PA189 (x12) PA190 ☒	☒ NJ225 ☒ 70x88x9mm, NBR ☒ NJ230 ☒ 126x150x14mm, MVQ	
JC292 ☒ ☉ JE107 (x2)			PA190	☒ NJ225 70x88x9mm, NBR ☒ NJ230 126x150x14mm, MVQ	



cc



Ø





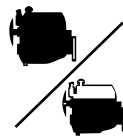





kW/PS



1	8140.61	2440	4	93.00		53/72		DE588 ▲ [6]	
2	Fiat-8040.02..	3460	4	100.00		60/81	AN460 (Fibre), 1.35mm	CN468 ▲■○	FN46A ▲○
3	CO 3/40..	4560	4	110.00		66/89	AN010 (Fibre)	CN01B ▲■○	FN01B ▲○ [7]
	CO 3/41..	4560	4	110.00		66/90		CN01E ■○	FN01E ○ [7]
4	8340.04.000/8340.04.250/ 8340.04.352/8340.04.362	4570	4	115.00		74/100	BD830 (Fibre)	DD832 ■○	GD832 ○
5	CO 3 D 130 VAR.1/ CO 3 D VAR.1/ CO 3 D VAR.15/ CO 3 D VAR.2/ CO 3 D VAR.4/CO 3 VAR.20/ CO 3 VAR.21/CO 3 VAR.22/ CO 3 VAR.3	4940		110.00			AN010 (Fibre)	CN01B ▲■○ CN01E ■○	FN01B ▲○ [7] FN01E ○ [7]
	CO 3/7.200/CO 3/7.300	4940	4	110.00		76/103			
6	CO 3	4941	4	110.00			AN010 (Fibre)	CN01B ▲■○ CN01E ■○	FN01B ▲○ [7] FN01E ○ [7]
7	8340.05.291	5400	4	115.00		63/85	BD830 (Fibre)	DD832 ■○	GD832 ○
8	CP 3/42../CP 3/42.200/ CP 3/42.300/CP 3/52.300	7410	6	110.00		107/145	AN340 (Fibre)	CN344 ○ [7] CN347 ■○	FN344 ▲○ [7] FN349 ○
9	CP 3/1/CP 3/10	7412		110.00			AN340 (Fibre)	CN344 ○ [7] CN347 ■○	FN344 ▲○ [7] FN349 ○
10	8360.05	8100	6	115.00		103-124/ 140-169	AY020 (Fibre)	DD843 ○	

JC054 (x4)	JN594 [9]	JJ519				AN010	JC055
JC055 (x4)				NA5039 95x120x13mm, FPM		AN340	
						AN460	JE479
						AY020	JM666
						BD830	JN594
JA866 (x4)	JM666	HC331	PA159	NA5043 75x100x17mm, FPM	KK195 [14] KK196 [14] KL351 [14]	JA866	HC331
JE479						JC054	JJ519

		cc			9			cc			9
1006-6	Diesel	5985	6	100.00	129	6.354.4, T6.354.4	Diesel	5800	6	98.47	103
1006-6T	Diesel	5985	6	100.00	130	6.354.4, T6.354.4	Diesel	5800	6	98.47	104
3.152	Diesel	2500	3	91.49	13	6.354.4, T6.354.4	Diesel	5800	6	98.47	105
3.152	Diesel	2500	3	91.49	14	6.354.4, T6.354.4	Diesel	5800	6	98.47	106
3.152	Diesel	2500	3	91.49	15	AT4.236	Diesel	3866	4	98.47	48
3.152	Diesel	2500	3	91.49	16	C4.236	Diesel	3866	4	98.47	49
3.152.2	Diesel	2500	3	91.40	17	C4.236	Diesel	3866	4	98.47	50
3.152.4	Diesel	2500	3	91.40	18	C4.236	Diesel	3866	4	98.47	51
4.107	Diesel	1760	4	79.37	2	C4.40	Diesel	3990	4	100.00	63
4.107	Diesel	1760	4	79.37	3	C6.354.4	Diesel	5800	6	98.47	107
4.107	Diesel	1760	4	79.37	4	CC6.60	Diesel	5985	6	100.00	131
4.107	Diesel	1760	4	79.37	5	D3.152	Diesel	2500	3	91.40	19
4.108	Diesel	1760	4	79.37	6	D3.152	Diesel	2500	3	91.49	20
4.108	Diesel	1760	4	79.37	7	D3.152	Diesel	2500	3	91.49	21
4.108	Diesel	1760	4	79.37	8	D3.152	Diesel	2500	3	91.49	22
4.108	Diesel	1760	4	79.37	9	D3.152	Diesel	2500	3	91.49	23
4.108	Diesel	1760	4	79.37	10	D3.152	Diesel	2500	3	91.49	24
4.203	Diesel	3300	4	91.40	26	D4.203	Diesel	3300	4	91.40	31
4.203	Diesel	3300	4	91.40	27	D4.203	Diesel	3300	4	91.40	32
4.203.2	Diesel	3300	4	91.40	28	D4.203	Diesel	3300	4	91.49	33
4.203.2	Diesel	3300	4	91.40	29	G4.203	Petrol	3300	4	91.40	34
4.203.2	Diesel	3300	4	91.49	30	G4.203	Petrol	3300	4	91.40	35
4.212	Diesel	3470	4	98.47	36	G4.212	Petrol	3470	4	98.47	39
4.212	Diesel	3470	4	98.47	37	G4.236	Petrol	3866	4	98.40	52
4.212	Diesel	3470	4	98.47	38	G4.236	Petrol	3866	4	98.40	53
4.236	Diesel	3866	4	98.47	40	G4.236	Petrol	3866	4	98.40	54
4.236	Diesel	3866	4	98.47	41	G4.236	Petrol	3866	4	98.40	55
4.236	Diesel	3866	4	98.47	42	G4.236	Petrol	3866	4	98.40	56
4.236	Diesel	3866	4	98.47	43	H6.354	Diesel	5800	6	98.47	108
4.236	Diesel	3866	4	98.47	44	H6.354.4	Diesel	5800	6	98.47	109
4.236	Diesel	3866	4	98.47	45	HT6.354	Diesel	5800	6	98.40	110
4.236	Diesel	3866	4	98.47	46	Prima 65	Diesel	1994	4	84.44	11
4.236	Diesel	3866	4	98.47	47	Prima 80T	Diesel	1994	4	84.44	12
4.248	Diesel	4065	4	101.00	65	T3.152.4	Diesel	2500	3	91.40	25
4.248	Diesel	4065	4	101.00	66	T4.236	Diesel	3866	4	98.47	57
4.248	Diesel	4065	4	101.00	67	T4.236	Diesel	3866	4	98.47	58
4.248	Diesel	4065	4	101.00	68	T4.236	Diesel	3866	4	98.47	59
4.248	Diesel	4065	4	101.00	69	T4.236	Diesel	3866	4	98.47	60
4.248.2	Diesel	4065	4	101.00	70	T4.236	Diesel	3866	4	98.47	61
4.248.2	Diesel	4065	4	101.00	71	T4.40	Diesel	3990	4	100.00	64
4.40	Diesel	3990	4	100.00	62	T6.354	Diesel	5800	6	98.40	111
4.99	Diesel	1621	4	76.20	1	T6.354	Diesel	5800	6	98.40	112
6.306	Diesel	5800	6	91.40	72	T6.354	Diesel	5800	6	98.40	113
6.354	Diesel	5800	6	98.47	73	T6.354.1	Diesel	5800	6	98.47	114
6.354	Diesel	5800	6	98.47	74	T6.354.1	Diesel	5800	6	98.47	115
6.354	Diesel	5800	6	98.47	75	T6.354.1	Diesel	5800	6	98.47	116
6.354	Diesel	5800	6	98.47	76	T6.354.1	Diesel	5800	6	98.47	117
6.354	Diesel	5800	6	98.47	77	T6.354.1	Diesel	5800	6	98.47	118
6.354	Diesel	5800	6	98.47	78	T6.354.4	Diesel	5800	6	98.47	119
6.354	Diesel	5800	6	98.47	79	T6.354.4	Diesel	5800	6	98.47	120
6.354	Diesel	5800	6	98.47	80	T6.354.4	Diesel	5800	6	98.47	121
6.354	Diesel	5800	6	98.47	81	T6.354.4	Diesel	5800	6	98.47	122
6.354.1	Diesel	5800	6	98.47	82	T6.354.4	Diesel	5800	6	98.47	123
6.354.1	Diesel	5800	6	98.47	83	T6.354.4	Diesel	5800	6	98.47	124
6.354.1	Diesel	5800	6	98.47	84	T6.354.4	Diesel	5800	6	98.47	125
6.354.1	Diesel	5800	6	98.47	85	T6.354.4	Diesel	5800	6	98.47	126
6.354.1	Diesel	5800	6	98.47	86	T6.354.4	Diesel	5800	6	98.47	127
6.354.2	Diesel	5800	6	98.47	87	T6.354.4	Diesel	5800	6	98.47	128
6.354.2	Diesel	5800	6	98.47	88	T6.354.4	Diesel	5800	6	98.47	134
6.354.2	Diesel	5800	6	98.47	89	V8.510/AV8.510	Diesel	8360	8	107.95	132
6.354.2	Diesel	5800	6	98.47	90	V8.540	Diesel	8830	8	107.95	133
6.354.2	Diesel	5800	6	98.47	91						
6.354.2	Diesel	5800	6	98.47	92						
6.354.2	Diesel	5800	6	98.47	93						
6.354.4	Diesel	5800	6	98.47	94						
6.354.4	Diesel	5800	6	98.47	95						
6.354.4	Diesel	5800	6	98.47	96						
6.354.4	Diesel	5800	6	98.47	97						
6.354.4	Diesel	5800	6	98.47	98						
6.354.4	Diesel	5800	6	98.47	99						
6.354.4	Diesel	5800	6	98.47	100						
6.354.4	Diesel	5800	6	98.47	101						
6.354.4	Diesel	5800	6	98.47	102						

9	9	9	9	9
4.107	4.107	4.108	4.108	4.108
00142 3	21035 4	ED20494 6	ED22363 6	ED50218 7
00164 3	21037 5	ED20607 6	ED22368 6	ED50250 7
00173 3	21050 4	ED20788 10	ED22369 6	ED50281 7
00184 3	21061 4	ED20789 9	ED22374 7	ED65019F 10
00222 3	21121 3	ED20804 8	ED22389 6	ED65020F 10
00225 2	21151 3	ED20829 7	ED22392 6	ED65021F 10
00241 4	21266 3	ED20897 6	ED22400 7	ED65022F 10
00242 4	21390 4	ED20918 9	ED22432 9	ED65023F 10
00243 4	21523 2	ED20939 6	ED22433 6	ED65024F 10
05838 3	21573 4	ED20941 8	ED22455 7	ED65025F 10
05971 3	21598 4	ED20942 8	ED22504 7	ED65026F 7
06327 4	21607 3	ED20954 6	ED22516 7	ED65027F 7
06422 3	21645 3	ED20958 7	ED22564 7	ED65028F 7
07247 3	21680 3	ED21053 7	ED22613 7	ED65029F 7
07372 3	21707 2	ED21054 7	ED22659 7	ED65030F 7
07433 3	21810 3	ED21073 7	ED22674 7	ED65031F 7
07460 3	21923 3	ED21077 6	ED22714 7	ED65032F 7
07627 3	21926 3	ED21128 7	ED22716 7	ED65033F 7
07676 3	22224 3	ED21140 6	ED22718 6	ED65034F 7
07677 3	4.108	ED21166 6	ED22720 6	ED65035F 7
07678 4	ED00259 6	ED21220 8	ED22737 7	ED65036F 7
07961 3	ED00267 7	ED21227 6	ED22741 7	ED65038F 7
08240 3	ED00268 7	ED21256 6	ED22754 7	ED65039F 10
08261 3	ED00269 6	ED21259 7	ED22761 7	ED65041F 7
08262 4	ED00328 6	ED21348 7	ED22767 7	ED65042F 7
08263 3	ED00351 7	ED21505 7	ED22771 6	ED65044F 7
08290 3	ED00352 6	ED21506 7	ED22774 6	ED65050F 7
08460 3	ED00353 7	ED21512 7	ED22775 6	ED65051F 7
08480 4	ED00365 6	ED21539 7	ED22776 6	ED65052F 10
08516 3	ED00388 7	ED21541 6	ED22779 6	ED65060F 7
08536 3	ED00389 7	ED21642 6	ED22793 7	ED65062F 10
08602 3	ED00400 6	ED21644 7	ED22797 6	ED65063F 7
08829 3	ED00415 7	ED21653 6	ED22799 7	ED65068F 7
08846 3	ED08820 7	ED21666 6	ED30080 6	ED65070F 10
08900 3	ED08941 7	ED21667 6	ED31062 7	ED65072F 7
20009 3	ED09307F 7	ED21686 6	ED33183 6	ED65073F 7
20018 3	ED13469 7	ED21687 6	ED33189 7	ED65081F 7
20088 3	ED13520 7	ED21698 8	ED33191 7	ED65082F 7
20118 3	ED13541 7	ED21742 6	ED33192 7	ED65083F 10
20152 3	ED13558 7	ED21749 6	ED33194 7	ED65084F 7
20332 4	ED13562 7	ED21754 6	ED33195 6	ED65085F 7
20397 3	ED13599 6	ED21755 6	ED33210 7	ED65086F 7
20398 4	ED13630 7	ED21803 6	ED33211 7	ED65087F 7
20429 4	ED13631 10	ED21815 7	ED33212 10	ED65088F 7
20482 3	ED13647 10	ED21833 6	ED33213 7	ED70035 7
20527 3	ED13664 7	ED21868 7	ED33214 7	ED70041 6
20548 3	ED20013 6	ED21919 6	ED33215 7	ED70044 7
20583 2	ED20035 7	ED21966 6	ED33218 7	ED70045 6
20585 2	ED20036 7	ED22063 6	ED50018 7	ED70048 7
20639 3	ED20043 7	ED22072 7	ED50025 7	ED70053 6
20681 3	ED20048 6	ED22109 7	ED50032 7	ED70058 7
20682 4	ED20138 7	ED22187 7	ED50033 7	ED70075 7
20689 3	ED20235 6	ED22195 7	ED50053 7	ED70077 7
20693 3	ED20291 6	ED22226 7	ED50063 6	ED70078 7
20698 4	ED20349 7	ED22229 6	ED50108 7	ED70080 6
20810 2	ED20350 7	ED22239 9	ED50109 7	ED70081 7
20830 3	ED20391 7	ED22284 6	ED50110 7	ED70132 7
20909 3	ED20392 7	ED22285 7	ED50137 7	ED70137 6
20962 3	ED20428 7	ED22288 6	ED50150 7	ED70154 6
20968 4	ED20442 7	ED22304 7	ED50187 7	ED70164 6

Build List • Num de lista de montage • No. de liste de montage • Anwendung Bauliste • De piezas elenco di costruzione
 Odniesienia do spisu czesci dla różnych wersji silnikowych • Перечень модификаций двигателей • قائمة بناء

9	9	9	9	9
4.108	3.152	3.152	3.152	4.203
ED70169 7	CE20369 23	CE22537 22	CE70056 22	JD00163 27
ED70172 6	CE20405 22	CE22538 22	CE80024 22	JD00166 27
ED80053 6	CE20425 19	CE22539 22	CE80025 22	JD00187 27
ED80056 8	CE20564 22	CE22545 22	CE80027 22	JD00188 27
ED80074 7	CE20581 23	CE22576 23	CE80035 22	JD00189 27
ED80138 7	CE20744 23	CE22601 23	CE80042 22	JD00190 27
ED80139 10	CE20770 22	CE22651 24	CE80048 23	JD00310 26
ED80256 7	CE20801 24	CE22652 24	CE80058 23	JD00339 27
ED80258 7	CE20937 23	CE22657 23	CE80076 22	JD00340 27
ED80259 7	CE21131 19	CE22665 23	CE80079 23	JD00366 27
ED80276 7	CE21149 23	CE22680 23	CE80093 22,23	JD00367 27
ED80277 7	CE21150 23	CE22696 22	CE80096 23	JD00368 27
ED80286 7	CE21162 22	CE22697 24	CE80111 23	JD00393 27
ED80297 7	CE21261 24	CE22701 22	CE80132 22	JD00394 27
ED90017 7	CE21393 22	CE22706 23	CE80141 23	JD00395 27
ED90019 7	CE21394 23	CE22713 23	CE80156 23	JD00396 27
ED90020 6	CE21489 23	CE22717 23	CE80184 22	JD06774 27
ED90021 7	CE21490 24	CE22735 22	CE80188 22	JD06814 27
Prima	CE21528 24	CE30061 23	CE80216 22	JD06940 27
BA30144 11	CE21559 22	CE30063 22	CE80236 22	JD07048 27
BA30146 11	CE21575 19	CE30111 22	CE80241 22	JD07076 27
BA30147 11	CE21663 22	CE30112 22	CE80247 22	JD07217 27
BA30148 11	CE21665 23	CE30117 22	CE95231 22	JD07299 27
BA80469 11	CE21670 21	CE31047 23	CJ30060 17	JD07669 27
BB30143 12	CE21675 23	CE31048 23	CJ30062 17	JD07671 27
BB30145 12	CE21681 22	CE31064 23	CJ33111 17	JD07756 27
3.152	CE21690 23	CE31088 23	CJ33159 17	JD07757 27
CD00204 16	CE21753 22	CE31089 23	CJ50027 17	JD07816 27
CD00228 15	CE21783 22	CE31115 23	CJ50091 17	JD07977 27
CD00229 15	CE21802 23	CE31116 23	CJ80044 17	JD07979 27
CD00230 15	CE21899 23	CE31133 23	CJ80069 17	JD08235 27
CD20166 13	CE21900 23	CE31144 23	CJ80070 17	JD08450 27
CD22096 15	CE21906 23	CE31160 22	CJ80080 17	JD08604 27
CD22143 14	CE22002 22	CE31197 23	CM30115 18	JD08701 27
CE00264 22	CE22003 22	CE31205 23	CM30118 18	JD08783 27
CE00271 22	CE22009 24	CE31212 23	CM30171 18	JD08885 27
CE00323 23	CE22027 22	CE31223 22	CM33496 18	JD08931 27
CE00344 23	CE22087 22	CE33180 22	CM33513 18	JD08948 27
CE00357 22	CE22183 22	CE33416 22	CM33521 18	JD20074 27
CE00358 22	CE22193 22	CE33417 22	CM33531 18	JD20086 27
CE00380 22	CE22202 22	CE33439 22	CM50168 18	JD20089 27
CE00381 22	CE22205 22	CE33448 23	CM50170 18	JD20104 27
CE00382 22	CE22236 22	CE33453 22	CM50184 18	JD20126 27
CE00383 22	CE22309 24	CE33463 22	CM50186 18	JD20172 27
CE00408 23	CE22310 23	CE33481 22	CM80248 18	JD20173 27
CE00412 22	CE22311 23	CE33512 22	CM80262 18	JD20181 27
CE08348 24	CE22372 23	CE33535 22	CM80280 18	JD20182 27
CE08557 24	CE22393 22	CE33546 22	CM80285 18	JD20198 27
CE08624 20	CE22438 23	CE33559 22	CM80294 18	JD20334 27
CE08705 23	CE22443 22	CE33560 22	CM80316 18	JD20395 27
CE08878 23	CE22444 22	CE50066 22	CM80323 18	JD20473 27
CE13554 22	CE22445 22	CE50126 22	CN31139 25	JD20483 27
CE13559 22	CE22451 22	CE50127 22	CN31185 25	JD20519 27
CE13583 22	CE22463 23	CE50129 22	CN31187 25	JD20544 27
CE13760 22	CE22464 23	CE50159 22	CN31219 25	JD20560 27
CE13806 22	CE22465 23	CE50160 22	CN80244 25	JD20575 27
CE13811 22	CE22467 23	CE50276 23	CN80444 25	JD20578 27
CE20019 22	CE22521 23	CE50333 23	CN80467 25	JD20665 26
CE20124 22	CE22522 23	CE70021 22		JD20680 27
CE20304 22	CE22528 23	CE70024 22		JD20718 27

9	9	9	9	9					
4.203	4.203	4.203	4.203	4.236					
JD20852	27	JD22533	27	JE80223	31	JG50039	30	13200	41,47
JD20858	27	JD22549	27	JE80224	31	JG50135	30	13210	41,47
JD20869	27	JD22584	27	JF00294	34	JG50191	30	LD00256	40
JD20906	27	JD22616	27	JF00297	34	JG50200	30	LD00257	40
JD20922	27	JD22617	27	JF00301	34	JG65000F	30	LD00258	40
JD20965	27	JD22618	27	JF00304	34	JG70020	30	LD00261	44
JD21056	27	JD22626	27	JF00325	34	JG70037	30	LD00275	40
JD21152	27	JD22662	27	JF00369	34	JG70040	30	LD00317	40
JD21202	27	JE00250	33	JF00370	34	JG70043	30	LD00330	40
JD21206	27	JE00350	33	JF00371	34	JG70073	30	LD00347	46
JD21207	27	JE07072	33	JF21203	34	JG70074	30	LD00374	40
JD21252	27	JE07073	33	JF21231	34	JG70076	30	LD00375	40
JD21253	27	JE07723	33	JF21288	34	JG70079	29	LD00376	40
JD21262	27	JE07725	33	JF21294	34	JG70092	30	LD00377	40
JD21305	27	JE07855	33	JF21349	34	JG70099	30	LD00378	40
JD21365	27	JE07865	32	JF21448	34	JG70100	30	LD00379	40
JD21382	27	JE08282	33	JF21557	34	JG70105	29	LD08314	46
JD21383	27	JE08781	33	JF21609	34	JG70112	30	LD08315	46
JD21470	27	JE20020	33	JF21703	34	JG70113	30	LD08501	46
JD21471	27	JE20092	33	JF21716	34	JG70126	29	LD08595	40
JD21493	27	JE20111	33	JF21745	34	JG70129	30	LD08629	42
JD21494	27	JE20206	33	JF21832	34	JG70139	30	LD08646	42
JD21503	27	JE20290	33	JF21873	34	JG70143	30	LD08651	40
JD21515	27	JE20451	33	JF21969	34	JG70156	28	LD08656	40
JD21566	27	JE20849	33	JF22007	34	JG70162	28	LD08659	42
JD21608	27	JE20866	33	JF22134	34	JG80023	30	LD08710	44
JD21615	27	JE20899	33	JF22306	34	JG80031	30	LD08769	42
JD21624	27	JE20915	33	JF22668	34	JG80033	30	LD08784	40
JD21708	27	JE21315	33	JF30055	34	JG80036	30	LD08842	40
JD21709	27	JE21317	33	JF31041	34	JG80038	30	LD08889	40
JD21726	27	JE21587	33	JF33193	34	JG80047	30	LD08891	40
JD21727	27	JE21907	33	JF33217	34	JG80050	30	LD08906	40
JD21729	27	JE21948	33	JF50092	34	JG80101	32	LD08907	40
JD21751	27	JE22046	33	JF50136	34	JG80161	30	LD08917	40
JD21758	27	JE22060	33	JF50192	34	JG80168	30	LD08919	40
JD21759	27	JE22466	33	JF70030	34	JG80175	30	LD08920	40
JD21765	27	JE22472	33	JF70034	34	JG80186	30	LD08938	40
JD21766	27	JE22494	33	JF80169	34	JG80190	30	LD08946	40
JD21781	27	JE22499	33	JF80178	34	JG80233	30	LD08988	40
JD21782	27	JE22534	27	JF80257	35	JG80260	30	LD13156	41,47
JD21796	27	JE22670	33	JG09296F	27	JG80293	30	LD13264	41,47
JD21816	27	JE22707	33	JG30051	30	4.212		LD13518	41,47
JD21827	27	JE30053	32	JG30052	30	LA20703	38	LD13584	41,47
JD21874	27	JE30054	31	JG31037	30	LA21194	36	LD13675	41,47
JD21954	27	JE31052	32	JG31042	30	LA21195	36	LD13692	41,47
JD21964	27	JE31053	32	JG33109	30	LA21243	36	LD13732	41,47
JD22000	27	JE31063	33	JG33118	30	LA21245	36	LD13750	41,47
JD22028	27	JE33158	31	JG33123	27	LA21246	36	LD13754	41,47
JD22075	27	JE33174	31	JG33155	30	LA21247	36	LD13851	41,47
JD22082	27	JE33177	31	JG33157	30	LA21248	36	LD13883	41,47
JD22117	27	JE50084	31	JG33182	30	LA21419	37	LD13894	41,47
JD22133	27	JE70022	31	JG33184	30	LA21440	36	LD13938	41,47
JD22154	27	JE70023	31	JG33190	30	LA21441	36	LD13945	41,47
JD22162	27	JE70028	31	JG33209	29	LA21593	36	LD13954	41,47
JD22164	27	JE70033	31	JG33219	30	LA21912	36	LD13955	41,47
JD22277	27	JE70042	31	JG33224	30	LA22102	36	LD14420	44
JD22305	27	JE70072	31	JG50012	30	LA22207	36	LD14739	44
JD22423	27	JE70138	31	JG50017	30	LA22731	36	LD14882	44
JD22458	27	JE80130	32	JG50020	30	LB20751	39	LD20004	40
JD22518	27	JE80195	31	JG50030	30			LD20006	40

9	9	9	9	9
4.236	4.236	4.236	4.236	4.236
LD20022 46	LD20722 44	LD21481 40	LD22146 42	LD22679 46
LD20029 40	LD20732 40	LD21496 40	LD22153 40	LD22682 40
LD20082 41,47	LD20734 40	LD21497 40	LD22156 40	LD22684 40
LD20097 40	LD20736 46	LD21498 40	LD22181 40	LD22692 46
LD20135 40	LD20737 46	LD21513 40	LD22184 46	LD22694 46
LD20136 42	LD20747 46	LD21519 42	LD22186 46	LD22695 46
LD20137 42	LD20748 46	LD21521 41,47	LD22194 41,47	LD22715 41,47
LD20163 40	LD20750 46	LD21530 46	LD22196 40	LD22721 46
LD20170 40	LD20751 44	LD21532 44	LD22197 41,47	LD22724 40
LD20190 42	LD20754 42	LD21546 40	LD22199 40	LD22728 42
LD20191 40	LD20759 40	LD21553 44	LD22204 40	LD22729 42
LD20208 46	LD20805 40	LD21558 42	LD22227 44	LD22733 46
LD20209 46	LD20831 42	LD21594 46	LD22233 41,47	LD22742 46
LD20227 40	LD20839 44	LD21595 46	LD22238 46	LD22749 46
LD20275 40	LD20875 41,47	LD21625 42	LD22241 44	LD22750 46
LD20293 40	LD20879 40	LD21654 44	LD22242 41,47	LD22751 40
LD20320 40	LD20887 41,47	LD21655 42	LD22279 41,47	LD22756 46
LD20321 40	LD20905 40	LD21671 40	LD22299 40	LD22763 40
LD20338 40	LD20949 40	LD21672 40	LD22300 46	LD22769 41
LD20375 40	LD20956 40	LD21676 40	LD22307 41,47	LD22778 40
LD20384 42	LD20957 41,47	LD21682 40	LD22319 42	LD22781 46
LD20394 40	LD20972 41,47	LD21691 40	LD22366 42	LD22782 46
LD20401 42	LD20977 41,47	LD21693 41,47	LD22378 40	LD22783 46
LD20402 40	LD20981 41,47	LD21694 43	LD22382 42	LD22784 46
LD20406 40	LD20982 41,47	LD21696 40	LD22395 44	LD22785 46
LD20409 40	LD20984 41,47	LD21699 40	LD22398 40	LD22786 46
LD20413 40	LD20988 41,47	LD21710 41,47	LD22426 46	LD22800 40
LD20419 40	LD21038 42	LD21711 40	LD22435 40	LD22802 40
LD20421 40	LD21096 40	LD21731 40	LD22468 46	LD22807 40
LD20431 46	LD21099 40	LD21732 40	LD22469 46	LD22813 46
LD20432 46	LD21100 40	LD21733 40	LD22474 46	LD22816 41,47
LD20433 46	LD21106 41,47	LD21737 40	LD22475 46	LD22818 40
LD20434 46	LD21109 46	LD21741 42	LD22476 46	LD22822 41,47
LD20436 42	LD21110 41,47	LD21743 40	LD22480 46	LD22824 46
LD20449 40	LD21125 46	LD21747 40	LD22483 46	LD22825 46
LD20450 40	LD21153 46	LD21748 40	LD22484 46	LD22826 46
LD20452 40	LD21167 42	LD21757 40	LD22485 46	LD22827 46
LD20461 46	LD21176 42	LD21760 40	LD22492 46	LD30101 41
LD20462 46	LD21187 40	LD21764 40	LD22496 46	LD30119 40
LD20488 40	LD21196 46	LD21770 40	LD22497 46	LD30137 41
LD20489 42	LD21197 46	LD21771 40	LD22498 46	LD31078 46
LD20512 40	LD21204 41,47	LD21778 40	LD22532 46	LD31085 46
LD20546 44	LD21217 40	LD21779 40	LD22535 41,47	LD31096 46
LD20555 40	LD21226 41,47	LD21788 42	LD22536 41,47	LD31097 46
LD20562 40	LD21270 44	LD21826 40	LD22546 46	LD31098 46
LD20586 40	LD21282 46	LD21870 42	LD22560 40	LD31104 46
LD20587 40	LD21297 46	LD21875 42	LD22573 46	LD31110 46
LD20593 46	LD21324 40	LD21876 41,47	LD22574 46	LD31113 46
LD20601 41,47	LD21325 42	LD21878 40	LD22596 40	LD31114 46
LD20631 41,47	LD21334 40	LD21886 40	LD22602 40	LD31122 46
LD20642 40	LD21343 40	LD21889 41,47	LD22620 46	LD31132 46
LD20648 40	LD21359 41,47	LD21896 41,47	LD22627 40	LD31134 46
LD20653 41,47	LD21360 41,47	LD21908 46	LD22634 41,47	LD31137 46
LD20663 41,47	LD21373 44	LD21937 40	LD22636 44	LD31140 46
LD20667 42	LD21385 41,47	LD21974 46	LD22640 46	LD31154 46
LD20668 40	LD21386 41,47	LD22043 41,47	LD22641 46	LD31163 46
LD20677 40	LD21395 40	LD22044 41,47	LD22642 46	LD31172 46
LD20692 40	LD21408 42	LD22051 46	LD22644 40	LD31173 46
LD20714 42	LD21417 41,47	LD22052 46	LD22671 46	LD31174 46
LD20721 44	LD21425 46	LD22055 46	LD22676 46	LD31175 46

9		9		9		9		9	
4.236		4.236		4.236		4.236		4.236	
LD31178	46	LD33672	41,47	LD70208	41,47	LD90055	41,47	LJ33475	61
LD31179	46	LD33673	41,47	LD70211	41	LD90056	41,47	LJ33476	61
LD31188	46	LD33676	46	LD70214	46	LE00326	53	LJ33494	61
LD31190	46	LD33678	40	LD80055	40	LE20723	52	LJ33518	61
LD31193	46	LD33681	40	LD80064	41	LE20724	52	LJ33537	60
LD31194	41	LD33682	41,47	LD80077	40	LE20752	52	LJ33539	58
LD31199	46	LD33683	40	LD80085	40	LE21010	56	LJ33548	60
LD31200	46	LD33690	46	LD80086	40	LE21017	52	LJ33583	61
LD31201	46	LD50094	40	LD80090	46	LE21060	52	LJ33590	61
LD31209	46	LD50096	46	LD80092	46	LE21093	56	LJ33603	61
LD31210	46	LD50103	46	LD80094	46	LE21111	52	LJ33614	57
LD33447	40	LD50104	46	LD80095	46	LE21119	52	LJ33619	61
LD33456	40	LD50105	46	LD80099	46	LE21160	52	LJ33633	61
LD33457	40	LD50107	42	LD80100	46	LE21205	52	LJ33638	61
LD33458	40	LD50119	40	LD80105	46	LE21623	52	LJ33644	61
LD33460	40	LD50131	40	LD80108	46	LE21890	52	LJ33645	48
LD33465	40	LD50143	46	LD80109	46	LE21892	52	LJ33646	61
LD33472	40	LD50145	46	LD80114	40	LE21897	52	LJ33661	61
LD33473	40	LD50148	40	LD80120	46	LE21962	52	LJ33664	61
LD33498	40	LD50158	40	LD80133	40	LE22555	52	LJ33677	57
LD33502	40	LD50161	40	LD80147	42	LE50095	52	LJ33684	57
LD33503	40	LD50167	40	LD80162	43	LE50138	53	LJ33685	57
LD33507	40	LD50176	46	LD80166	43	LE70054	52	LJ50079	61
LD33508	40	LD50179	46	LD80174	40	LE70089	52	LJ50117	61
LD33509	40	LD50204	46	LD80179	40	LE70098	52	LJ50182	57
LD33514	40	LD50220	41	LD80181	46	LE70110	53	LJ50183	57
LD33519	40	LD50221	41	LD80182	41,47	LE70148	52	LJ50194	57
LD33522	40	LD50222	41	LD80185	40	LE70157	52	LJ50198	57
LD33524	40	LD50245	41	LD80201	41,47	LE70163	52	LJ50201	57
LD33528	40	LD50251	40	LD80202	44	LE70175	52	LJ50211	61
LD33529	40	LD50270	41,47	LD80217	40	LE70182	52	LJ50223	59
LD33532	40	LD50278	46	LD80227	46	LE70185	52	LJ50224	59
LD33538	40	LD65058F	46	LD80235	46	LE70191	52	LJ50230	57
LD33540	40	LD70047	40	LD80239	40	LE70193	53	LJ50231	61
LD33547	40	LD70055	41,47	LD80243	43	LE80078	53	LJ50244	57
LD33550	40	LD70082	40	LD80249	44	LE80128	53	LJ50252	57
LD33555	40	LD70085	41,47	LD80253	41,47	LE80173	52	LJ50272	57
LD33565	40	LD70101	44	LD80263	41	LE80177	52	LJ50274	61
LD33566	40	LD70111	44	LD80266	40	LE80290	54	LJ70128	61
LD33597	41,47	LD70115	41	LD80271	40	LE80311	52	LJ70155	61
LD33600	40	LD70116	40	LD80278	40	LE80397	53	LJ70166	61
LD33612	40	LD70117	40	LD80291	41,47	LE80411	55	LJ70168	58
LD33616	40	LD70118	40	LD80299	41,47	LH31207	51	LJ70183	61
LD33622	45	LD70119	40	LD80301	46	LH50133	50	LJ80192	61
LD33623	44	LD70121	40	LD80336	41	LH50149	50	LJ80193	57
LD33624	40	LD70124	40	LD80348	41,47	LH50169	50	LJ80196	61
LD33626	40	LD70125	41,47	LD80349	41,47	LH50205	50	LJ80197	61
LD33632	40	LD70131	40	LD80352	41	LH50225	51	LJ80232	57
LD33636	41	LD70147	40	LD80364	40	LH50226	51	LJ80270	61
LD33639	40	LD70150	40	LD80366	40	LH70202	49	LJ80302	61
LD33643	40	LD70152	40	LD80369	40	LH70213	49	LJ80322	61
LD33647	41	LD70160	40	LD80370	46	LJ30138	59	LJ80335	61
LD33648	41	LD70178	46	LD80371	46	LJ31131	57	LJ80337	61
LD33649	41	LD70179	46	LD80394	40	LJ31142	59	LJ80354	59
LD33650	41	LD70195	40	LD80406	40	LJ31153	57	LJ80381	58
LD33654	40	LD70196	41	LD80416	41,47	LJ31191	57	LJ80382	57
LD33655	41	LD70197	40	LD80418	44	LJ31217	57	LJ80386	58
LD33660	40	LD70200	46	LD90012	41,47	LJ33438	61	LJ80395	61
LD33665	40	LD70201	46	LD90047	40	LJ33467	57	LJ80404	61
LD33671	41,47	LD70204	44	LD90052	41,47	LJ33474	61	LJ80415	41

9	9	9	9	9
4.40	4.40	4.40	4.248	4.248
AA9A100 62	AA80604 62	AB80525 64	LF21597 66	LF31128 66
AA9A490 62	AA80614 62	AB80532 64	LF21614 68	LF31130 66
AA3112PL95 62	AB2420PL05 64	AB80575 64	LF21617 65	LF31135 66
AA30128 62	AB3113PL95 64	AB80577 64	LF21618 65	LF33464 68
AA30142 62	AB30126 64	AB80581 64	LF21622 65	LF50098 65
AA30150 62	AB30132 64	AB80596 64	LF21652 65	LF80057 68
AA30164 62	AB30133 64	AB80599 64	LF21678 65	LF80091 66
AA30165 62	AB30151 64	AB80600 64	LF21772 65	LF80098 66
AA30500 62	AB30158 64	AB80601 64	LF21780 65	LF80106 66
AA30501 62	AB30550 64	AB80613 64	LF21824 66	LF80121 66
AA30503 62	AB30551 64	AC10000 63	LF21852 65	LF80155 65
AA30504 62	AB30553 64	AC50283 63	LF21853 65	LF80172 65
AA31238 62	AB30554 64	AC50290 63	LF21881 65	LF80240 69
AA50241 62	AB50253 64	4.248	LF21909 66	LF80305 66
AA50254 62	AB50256 64	21668 69	LF21922 68	LF80310 68
AA50255 62	AB50260 64	LF00282 65	LF21938 66	LG33443 71
AA50261 62	AB50262 64	LF00346 68	LF21939 66	LG33444 71
AA50264 62	AB50265 64	LF00348 66	LF21947 66	LG50067 71
AA50267 62	AB50266 64	LF00392 68	LF22165 66	LG70069 71
AA50271 62	AB50268 64	LF00399 66	LF22269 66	LG70090 70
AA50291 62	AB50277 64	LF00403 66	LF22295 66	LG70091 70
AA50315 62	AB50279 64	LF00404 66	LF22308 66	LG70103 71
AA50324 62	AB50304 64	LF09301F 66	LF22312 66	LG70104 71
AA50329 62	AB50305 64	LF20490 66	LF22313 66	LG70106 71
AA50343 62	AB50313 64	LF20491 66	LF22418 66	LG70109 71
AA50377 62	AB50336 64	LF20520 66	LF22434 65	LG70127 71
AA50386 62	AB50337 64	LF20525 66	LF22471 66	LG70159 71
AA50392 62	AB50341 64	LF20534 66	LF22473 66	LG70174 71
AA50393 62	AB50344 64	LF20543 66	LF22474 66	LG70188 71
AA50420 62	AB50364 64	LF20643 66	LF22477 66	LG80123 71
AA60022 62	AB50365 64	LF20738 66	LF22478 66	LG80163 71
AA70216 62	AB50370 64	LF20739 66	LF22486 66	6.306
AA70218 62	AB50371 64	LF20855 65	LF22487 66	20005 72
AA70219 62	AB50372 64	LF20865 65	LF22489 66	6.354
AA70240 62	AB50385 64	LF20896 65	LF22503 67	20005 78
AA70268 62	AB50387 64	LF20946 66	LF22552 65	TC00199 78
AA80408 62	AB50388 64	LF20948 66	LF22561 68	TC00206 78
AA80420 62	AB50389 64	LF20952 66	LF22569 68	TC00207 78
AA80427 62	AB50391 64	LF20985 65	LF22575 66	TC00214 78
AA80435 62	AB50396 64	LF21003 65	LF22595 66	TC00215 78
AA80446 62	AB50421 64	LF21022 65	LF22639 66	TC00216 78
AA80448 62	AB60019 64	LF21023 68	LF22646 66	TC00217 78
AA80514 62	AB60020 64	LF21069 65	LF22663 66	TC00219 78
AA80516 62	AB70215 64	LF21097 65	LF22672 66	TC00232 78
AA80522 62	AB70241 64	LF21098 65	LF22683 66	TC00237 75
AA80531 62	AB70242 64	LF21126 66	LF22704 66	TC00306 76
AA80536 62	AB70267 64	LF21200 66	LF22762 66	TC00314 78
AA80537 62	AB80409 64	LF21201 66	LF22790 66	TC00331 78
AA80539 62	AB80421 64	LF21237 65	LF22791 66	TC00332 78
AA80545 62	AB80432 64	LF21274 68	LF22792 66	TC00337 78
AA80547 62	AB80434 64	LF21313 68	LF22794 68	TC00338 78
AA80550 62	AB80438 64	LF21401 65	LF22801 68	TC00372 78
AA80555 62	AB80447 64	LF21415 66	LF22812 66	TC00373 78
AA80556 62	AB80468 64	LF21416 66	LF22813 66	TC00390 78
AA80563 62	AB80483 64	LF21423 65	LF31071 66	TC00391 78
AA80565 62	AB80491 64	LF21577 66	LF31086 66	TC07145 81
AA80576 62	AB80494 64	LF21578 66	LF31091 66	TC07278 78
AA80595 62	AB80495 64	LF21579 66	LF31092 66	TC07342 78
AA80597 62	AB80503 64	LF21586 66	LF31105 66	TC07374 78
AA80603 62	AB80520 64	LF21596 66	LF31109 66	TC07415 78

9	9	9	9	9
6.354	6.354	6.354	6.354	6.354
TC07429 78	TC20298 78	TC20818 78	TC21238 78	TC21811 78
TC07430 78	TC20303 78	TC20825 78	TC21251 78	TC21820 79
TC07436 78	TC20309 78	TC20844 78	TC21257 78	TC21831 78
TC07571 75	TC20310 78	TC20850 78	TC21258 78	TC21864 78
TC07635 78	TC20343 78	TC20853 78	TC21268 78	TC21866 78
TC07653 78	TC20356 78	TC20860 78	TC21271 75	TC21880 78
TC07654 78	TC20374 78	TC20873 78	TC21273 78	TC21884 78
TC07662 78	TC20376 78	TC20889 78	TC21275 78	TC21885 78
TC07759 78	TC20396 78	TC20891 78	TC21276 78	TC21887 78
TC07869 78	TC20400 78	TC20892 78	TC21277 78	TC21903 78
TC07876 78	TC20403 78	TC20895 78	TC21281 78	TC21916 78
TC07939 78	TC20414 78	TC20907 78	TC21285 79	TC21933 78
TC07951 78	TC20423 78	TC20914 78	TC21295 75	TC21935 75
TC08239 78	TC20435 78	TC20920 78	TC21296 78	TC21936 78
TC08319 78	TC20437 78	TC20927 75	TC21298 78	TC21949 78
TC08396 78	TC20441 78	TC20928 78	TC21321 75	TC21957 78
TC08462 78	TC20446 78	TC20945 78	TC21326 80	TC22042 78
TC08476 78	TC20453 78	TC20959 78	TC21330 78	TC22112 78
TC08477 78	TC20454 78	TC20961 78	TC21331 78	TC22115 78
TC08540 78	TC20459 74	TC20973 78	TC21332 78	TC22116 78
TC08603 77	TC20463 78	TC20983 75	TC21333 78	TC22118 78
TC08614 78	TC20465 78	TC20993 78	TC21338 78	TC22131 73
TC08615 78	TC20469 78	TC20994 78	TC21341 78	TC22147 75
TC08619 78	TC20492 81	TC21001 78	TC21364 78	TC22149 75
TC08644 78	TC20503 78	TC21002 78	TC21368 75	TC22161 78
TC08662 78	TC20509 78	TC21020 74	TC21369 75	TC22166 78
TC08663 78	TC20510 78	TC21027 78	TC21370 78	TC22168 78
TC08684 78	TC20511 78	TC21040 78	TC21371 78	TC22201 75
TC08702 78	TC20514 78	TC21041 78	TC21372 78	TC22225 78
TC08819 78	TC20522 79	TC21047 78	TC21374 78	TC22231 78
TC08860 78	TC20523 78	TC21058 78	TC21375 78	TC22266 78
TC08904 78	TC20530 78	TC21059 78	TC21406 76	TC22267 78
TC08995 78	TC20535 78	TC21071 78	TC21418 78	TC22274 80
TC13620 78	TC20549 78	TC21074 78	TC21426 78	TC22276 79
TC13633 78	TC20553 78	TC21078 81	TC21427 78	TC22301 78
TC13682 78	TC20554 74	TC21080 75	TC21429 81	TC22377 78
TC13732 78	TC20557 78	TC21081 78	TC21447 78	TC22390 75
TC13735 78	TC20566 78	TC21091 78	TC21457 78	TC22436 79
TC13823 78	TC20571 75	TC21092 78	TC21517 78	TC22446 78
TC20014 78	TC20590 78	TC21094 78	TC21538 75	TC22460 78
TC20067 78	TC20591 78	TC21104 78	TC21545 78	TC22514 79
TC20069 78	TC20627 78	TC21107 78	TC21551 78	TC22544 78
TC20073 78	TC20630 78	TC21112 78	TC21629 78	TC22635 74
TC20077 78	TC20635 78	TC21129 78	TC21630 78	TC22710 78
TC20084 78	TC20651 75	TC21139 74	TC21635 78	TC98609 78
TC20101 78	TC20652 78	TC21142 75	TC21636 78	TD00245 108
TC20102 78	TC20673 78	TC21143 78	TC21639 78	TD00307 108
TC20120 78	TC20687 78	TC21144 78	TC21640 78	TD07573 108
TC20123 75	TC20694 78	TC21156 78	TC21641 78	TD20389 108
TC20142 78	TC20695 78	TC21164 78	TC21660 78	TD21329 108
TC20143 78	TC20717 78	TC21180 75	TC21692 78	TE00262 112
TC20146 74	TC20733 78	TC21181 78	TC21702 78	TE00272 113
TC20148 78	TC20763 78	TC21183 78	TC21706 78	TE00273 113
TC20185 78	TC20764 78	TC21184 78	TC21714 78	TE00278 112
TC20196 78	TC20767 73	TC21185 78	TC21719 78	TE00302 112
TC20197 78	TC20778 78	TC21192 75	TC21744 78	TE00303 112
TC20230 78	TC20790 78	TC21212 78	TC21746 80	TE08861 111
TC20243 79	TC20791 78	TC21216 78	TC21773 78	TE09846 111
TC20267 78	TC20792 78	TC21233 78	TC21784 78	TE09847 112
TC20282 78	TC20808 78	TC21235 78	TC21787 78	TE20696 111

9		9		9		9		9	
6.354		6.354		6.354		6.354		6.354	
TE20700	111	TH21628	87	TU30070	119	TU33096	103	TU33516	98
TE20701	111	TH21722	118	TU30086	119	TU33099	126	TU33549	120
TE20773	113	TH21794	87	TU30122	120	TU33100	103	TU33564	119
TE20775	113	TH21883	87	TU31004	127	TU33102	103	TU50005	119
TE20779	113	TH22180	87	TU31006	119	TU33103	103	TU50006	126
TE20862	113	TH22270	118	TU31009	121	TU33108	103	TU50011	119
TE20890	113	TH22282	87	TU31010	126	TU33126	119	TU50021	119
TE20908	113	TH22431	118	TU31011	119	TU33130	119	TU50024	126
TE20940	113	TH22481	116	TU31016	121	TU33146	119	TU50028	126
TE20943	113	TH22571	118	TU31025	125	TU33170	119	TU50037	125
TE20947	113	TJ00292	95	TU31045	126	TU33171	119	TU50044	119
TE20969	111	TJ20820	115	TU31046	126	TU33172	119	TU50060	119
TE21028	113	TJ21018	114	TU31074	119	TU33173	119	TU50061	119
TE21051	111	TJ21024	115	TU31076	119	TU33185	103	TU50064	103
TE21108	113	TJ21036	115	TU31077	119	TU33202	103	TU50068	119
TE21286	111	TJ21042	114	TU31093	106	TU33203	103	TU50087	123
TE21287	111	TJ21043	115	TU31094	106	TU33204	103	TU50090	123
TE21791	111	TJ21057	91	TU31095	126	TU33205	103	TU50101	106
TE21792	111	TJ21141	114	TU31101	123	TU33206	103	TU50112	103
TE21842	111	TJ21173	91	TU31107	125	TU33207	103	TU50116	123
TE21843	111	TJ21174	91	TU31112	119	TU33208	103	TU50120	119
TE21856	111	TJ21175	91	TU31124	119	TU33304	103	TU50132	123
TE21891	111	TJ21228	91	TU31126	119	TU33307	104	TU50134	120
TE22132	111	TJ21310	114	TU31129	119	TU33311	104	TU50151	119
TE22364	111	TJ21311	114	TU31143	106	TU33322	103	TU50152	119
TE22365	111	TJ21312	114	TU31145	106	TU33330	123	TU50166	119
TE22380	111	TJ21378	115	TU33002	119	TU33332	103	TU50172	128
TF00263	110	TJ21464	114	TU33008	119	TU33334	103	TU50185	123
TF00279	110	TJ21465	114	TU33014	126	TU33335	103	TU50188	119
TF00320	110	TJ21547	115	TU33015	119	TU33349	103	TU50203	119
TF00321	110	TJ21548	114	TU33016	119	TU33350	103	TU60004	119
TF08862	110	TJ21549	114	TU33017	119	TU33353	103	TU60006	119
TF20573	110	TJ21643	92	TU33018	119	TU33360	119	TU60010	119
TF20702	110	TJ21649	91	TU33022	105	TU33364	103	TU65010F	103
TF21012	110	TJ21651	92	TU33023	119	TU33382	103	TU65011F	103
TF21508	110	TJ21898	114	TU33024	119	TU33387	103	TU65012F	103
TF21509	110	TJ22034	114	TU33025	103	TU33389	103	TU65013F	103
TF21893	110	TJ22083	114	TU33028	103	TU33393	104	TU65014F	103
TF21894	110	TJ22169	114	TU33029	103	TU33394	104	TU65015F	103
TG00360	82	TJ22170	114	TU33035	119	TU33395	104	TU65016F	103
TG20563	83	TJ22256	114	TU33036	109	TU33396	104	TU65043F	103
TG21219	83	TJ22414	89	TU33041	105	TU33397	104	TU65045F	103
TG21225	82	TJ22461	93	TU33042	103	TU33401	103	TU65046F	103
TG21301	83	TJ22482	90	TU33045	103	TU33402	103	TU65047F	103
TG21303	85	TJ22491	114	TU33046	103	TU33404	122	TU65048F	103
TG21728	85	TJ22519	114	TU33047	103	TU33406	123	TU65049F	103
TG21855	83	TJ22563	114	TU33048	103	TU33407	103	TU65053F	103
TG21915	83	TT21724	118	TU33056	119	TU33409	103	TU65054F	103
TG21955	83	TU09323F	98	TU33058	119	TU33421	119	TU65055F	103
TG22271	83	TU30008	119	TU33063	103	TU33422	119	TU65056F	103
TG22453	83	TU30009	119	TU33065	103	TU33423	119	TU65057F	103
TG22550	83	TU30012	119	TU33068	103	TU33426	119	TU65059F	103
TG22572	86	TU30017	119	TU33074	119	TU33435	119	TU65061F	103
TG22577	86	TU30019	119	TU33075	103	TU33440	119	TU65071F	103
TG22585	84	TU30025	119	TU33076	103	TU33445	119	TU65075F	103
TH00308	117	TU30029	119	TU33079	119	TU33479	120	TU65078F	103
TH00356	88	TU30048	103	TU33081	103	TU33480	120	TU65080F	103
TH00359	118	TU30059	103	TU33082	103	TU33483	120	TU70001	119
TH21414	116	TU30066	103	TU33083	103	TU33490	98	TU70002	126
TH21449	87	TU30067	119	TU33092	119	TU33500	120	TU70013	119

9		9		9		9		9	
6.354		6.354		6.354		6.354		6.354	
TU70018	126	TW31003	100	TW33062	103	TW33200	103	TW33428	98
TU70019	119	TW31007	98	TW33064	103	TW33201	97	TW33429	98
TU70025	103	TW31008	100	TW33070	103	TW33220	104	TW33431	98
TU70027	103	TW31012	98	TW33073	98	TW33223	98	TW33432	98
TU70051	119	TW31013	98	TW33080	98	TW33301	98	TW33436	98
TU70062	103	TW31014	98	TW33088	103	TW33302	98	TW33446	98
TU70122	119	TW31015	98	TW33089	103	TW33305	103	TW33510	98
TU70140	103	TW31017	98	TW33090	102	TW33306	103	TW33511	98
TU70145	120	TW31027	94	TW33091	98	TW33309	98	TW33517	98
TU70146	120	TW31040	100	TW33093	103	TW33310	103	TW33533	98
TU70161	103	TW31044	98	TW33095	98	TW33317	97	TW50001	98
TU80001	119	TW31051	100	TW33097	103	TW33319	103	TW50002	98
TU80005	119	TW31054	98	TW33098	98	TW33325	103	TW50003	98
TU80009	119	TW31060	100	TW33101	103	TW33326	103	TW50004	98
TU80010	119	TW31061	98	TW33104	103	TW33327	98	TW50007	98
TU80026	125	TW31065	99	TW33105	103	TW33336	103	TW50008	98
TU80030	126	TW31066	98	TW33106	97	TW33337	103	TW50009	98
TU80051	126	TW31069	99	TW33107	103	TW33338	103	TW50010	98
TU80075	119	TW31070	99	TW33110	98	TW33341	103	TW50013	97
TU80084	119	TW31087	98	TW33112	98	TW33342	103	TW50022	97
TU80089	119	TW31108	97	TW33113	98	TW33343	103	TW50023	98
TU80097	120	TW31111	98	TW33115	98	TW33344	103	TW50029	98
TU80116	119	TW31125	100	TW33119	98	TW33345	103	TW50034	98
TU80125	119	TW31146	100	TW33120	98	TW33346	103	TW50035	101
TU80140	119	TW31147	98	TW33122	98	TW33347	98	TW50036	98
TU80144	119	TW31151	106	TW33124	98	TW33348	98	TW50043	98
TU80149	120	TW31155	106	TW33125	98	TW33351	103	TW50049	98
TU80164	119	TW31156	106	TW33127	98	TW33352	98	TW50050	98
TU80180	124	TW31159	106	TW33128	98	TW33354	103	TW50055	98
TU80204	119	TW31208	106	TW33129	98	TW33355	98	TW50056	98
TU80207	119	TW33001	98	TW33132	98	TW33356	97	TW50057	98
TU80220	119	TW33003	98	TW33134	98	TW33357	95	TW50059	98
TU80222	120	TW33004	98	TW33135	98	TW33358	103	TW50072	97
TU80228	120	TW33005	98	TW33136	98	TW33362	98	TW50073	98
TU80237	120	TW33006	98	TW33137	98	TW33365	103	TW50074	98
TU80246	119	TW33007	98	TW33138	98	TW33366	103	TW50075	97
TU80250	121	TW33009	98	TW33140	103	TW33367	103	TW50076	98
TU80281	119	TW33010	98	TW33141	98	TW33368	97	TW50080	98
TU80282	119	TW33011	98	TW33142	98	TW33369	98	TW50083	98
TU80283	119	TW33012	98	TW33143	95	TW33375	103	TW50100	98
TU80284	123	TW33013	98	TW33145	98	TW33376	103	TW50111	103
TU80288	124	TW33026	98	TW33149	103	TW33377	103	TW50113	98
TU80295	119	TW33027	103	TW33150	103	TW33378	98	TW50114	98
TU80303	119	TW33031	103	TW33153	98	TW33379	98	TW50115	98
TU80304	119	TW33032	103	TW33156	98	TW33380	98	TW50118	98
TW09319F	98	TW33033	103	TW33161	98	TW33383	98	TW50122	98
TW09328F	98	TW33034	103	TW33162	98	TW33386	103	TW50124	98
TW30001	98	TW33037	98	TW33163	98	TW33392	104	TW50139	98
TW30002	98	TW33038	103	TW33164	98	TW33400	103	TW50162	98
TW30003	98	TW33039	103	TW33165	98	TW33405	98	TW50163	98
TW30005	98	TW33040	98	TW33166	98	TW33408	103	TW50164	98
TW30007	96	TW33043	103	TW33167	98	TW33410	98	TW50165	98
TW30011	98	TW33044	103	TW33168	98	TW33411	98	TW50173	98
TW30022	98	TW33049	98	TW33169	98	TW33412	98	TW50177	98
TW30026	98	TW33050	103	TW33181	103	TW33413	98	TW50196	98
TW30028	98	TW33053	103	TW33186	103	TW33419	98	TW50202	98
TW30050	104	TW33054	103	TW33188	103	TW33420	98	TW60001	98
TW30081	103	TW33057	103	TW33196	103	TW33424	98	TW60007	98
TW30089	98	TW33060	103	TW33197	103	TW33425	98	TW60008	98
TW30121	98	TW33061	103	TW33199	103	TW33427	98	TW60011	98

Build List • Num de lista de montage • No. de liste de montage • Anwendung Bauliste • De piezas elenco di costruzione
 Odniesienia do spisu czesci dla różnych wersji silnikowych • Перечень модификаций двигателей • قائمة بناء

9		9		9		9		9	
6.354		6.354		1006-6		1006-6		6.60	
TW65001F	103	TW80112	98	YA31240	129	YB50286	130	YD50356	131
TW65002F	103	TW80115	100	YA31241	129	YB50287	130	YD50357	131
TW65003F	103	TW80117	103	YA31242	129	YB50288	130	YD50358	131
TW65004F	103	TW80122	98	YA31250	129	YB50292	130	YD50359	131
TW65005F	103	TW80124	98	YA31251	129	YB50297	130	YD50366	131
TW65006F	103	TW80129	103	YA31257	129	YB50298	130	YD50378	131
TW65007F	103	TW80142	98	YA50214	129	YB50299	130	YD50383	131
TW65008F	103	TW80143	98	YA50215	129	YB50314	130	YD50384	131
TW65009F	103	TW80148	98	YA50216	129	YB50321	130	YD50405	131
TW65037F	103	TW80150	98	YA50269	129	YB50322	130	YD50406	131
TW65064F	103	TW80152	103	YA50293	129	YB50327	130	YD50412	131
TW65065F	103	TW80165	97	YA50296	129	YB50328	130	YD50422	131
TW65066F	103	TW80176	100	YA50319	129	YB50345	130	YD60017	131
TW65067F	103	TW80189	99	YA50339	129	YB50346	130	YD60018	131
TW65069F	103	TW80191	98	YA50347	129	YB50363	130	YD70239	131
TW65074F	103	TW80198	97	YA50360	129	YB50367	130	YD70265	131
TW65076F	103	TW80234	98	YA50376	129	YB50375	130	YD80402	131
TW65077F	103	TW80242	98	YA50398	129	YB50400	130	YD80489	131
TW70003	98	TW80255	98	YA70217	129	YB50403	130	YD80505	131
TW70004	98	TW80261	98	YA70245	129	YB50407	130	YD80571	131
TW70005	98	TW80269	97	YA80384	129	YB50408	130	YD80605	131
TW70006	98	TW80279	98	YA80425	129	YB50411	130	YD80612	131
TW70007	98	TW80287	98	YA80433	129	YB70246	130	V8.510	
TW70008	100	TW80289	98	YA80449	129	YB80401	130	XA20499	132
TW70010	98	TW80307	98	YA80450	129	YB80426	130	XA20508	132
TW70014	98	TW80308	98	YA80451	129	YB80428	130	XA20515	132
TW70015	98	TW80319	105	YA80476	129	YB80430	130	XA20518	132
TW70016	98	TX50181	107	YA80478	129	YB80455	130	XA20526	132
TW70026	103	TX60003	107	YA80492	129	YB80477	130	XA20558	132
TW70031	98	TX60005	107	YA80493	129	YB80496	130	XA20565	132
TW70038	100	TX60012	107	YA80504	129	YB80518	130	XA20609	132
TW70050	98	TX60013	107	YA80515	129	YB80523	130	XA20613	132
TW70065	98	TX80113	107	YA80564	129	YB80524	130	XA20622	132
TW70087	103	TX80252	107	YA80569	129	YB80530	130	XA20623	132
TW70088	97	TY30056	109	YB9A040	130	YB80535	130	XA20625	132
TW70114	98	TY33069	109	YB2593PL95	130	YB80538	130	XA20626	132
TW70142	98	TY33094	109	YB30127	130	YB80567	130	XA20633	132
TW70158	97	TZ30057	109	YB30154	130	YB80573	130	XA20637	132
TW70171	98	TZ30058	103	YB30166	130	YB80584	130	XA20641	132
TW80004	97	TZ33051	109	YB30176	130	YB80591	130	XA20690	132
TW80006	98	TZ33055	109	YB30650	130	YB80602	130	XA20715	132
TW80007	97	TZ33066	109	YB30651	130	6.60		XA20716	132
TW80008	98	TZ33067	109	YB30652	130	YD30155	131	XA20756	132
TW80011	98	TZ33071	109	YB30653	130	YD30160	131	XA20803	132
TW80012	98	TZ33077	109	YB30654	130	YD30182	131	XA20840	132
TW80013	98	TZ33078	109	YB30655	130	YD30657	131	XA20841	132
TW80015	98	1006-6		YB30656	130	YD30658	131	XA20842	132
TW80019	98	YA30129	129	YB31228	130	YD30659	131	XA20845	132
TW80021	98	YA30159	129	YB31233	130	YD30660	131	XA20847	132
TW80029	97	YA30169	129	YB31236	130	YD30800	131	XA20856	132
TW80045	98	YA30600	129	YB31243	130	YD30801	131	XA20857	132
TW80059	98	YA30601	129	YB31245	130	YD30802	131	XA20880	132
TW80062	98	YA30602	129	YB31246	130	YD30803	131	XA20881	132
TW80065	94	YA30603	129	YB31247	130	YD50232	131	XA20882	132
TW80066	94	YA30604	129	YB50233	130	YD50235	131	XA20883	132
TW80083	98	YA30605	129	YB50234	130	YD50237	131	XA20884	132
TW80088	98	YA30606	129	YB50236	130	YD50243	131	XA20885	132
TW80103	98	YA30607	129	YB50238	130	YD50258	131	XA20900	132
TW80104	98	YA31230	129	YB50239	130	YD50289	131	XA20901	132
TW80110	98	YA31232	129	YB50273	130	YD50355	131	XA20902	132

9		9		9		9	
V8.510		V8.540		V8.540		V8.540	
XA20904	132	AO19310	133	XC22293	133	XE33504	133
XA20921	132	AO19359	133	XC22302	133	XE33520	133
XA20923	132	AO19361	133	XC22314	133	XE33567	133
XA20925	132	AO19403	133	XC22321	133	XE33593	133
XA20926	132	AO19404	133	XC22355	133	XE33607	133
XA20950	132	AO19417	133	XC22356	133	XE33608	133
XA20957	132	AO19439	133	XC22357	133	XE50123	133
XA20980	132	AO19440	133	XC22361	133	XE50153	133
XA21000	132	AO19528	133	XC22406	133	XE50189	133
XA21006	132	AO19530	133	XC22407	133	XE50190	133
XA21007	132	AO19545	133	XC22410	133	XE50193	133
XA21008	132	AO19546	133	XC22424	133	XE50199	133
XA21137	132	AO19547	133	XC22425	133	XE65079F	133
XA21362	132	AO19606	133	XC22427	133	XE65105F	133
XA21472	132	AO19634	133	XC22558	133	XE70123	133
XA21483	132	AO19648	133	XC22656	133	XE70133	133
XA21514	132	AO19658	133	XC22675	133	XE70134	133
XA21518	132	AO19685	133	XC22719	133	XE70135	133
XA21542	132	AO19687	133	XC22732	133	XE70136	133
XA21543	132	AO19723	133	XC22752	133	XE80214	133
XA21612	132	AO19724	133	XC22757	133	XE80245	133
XA21613	132	AO19740	133	XC30071	133		
XA21619	132	AO19767	133	XC31043	133		
XA21634	132	AO19789	133	XC31072	133		
XA21664	132	AO19814	133	XC31090	133		
XA21683	132	AO19836	133	XC33175	133		
XA21685	132	AO19855	133	XC33221	133		
XA21704	132	AO19875	133	XC33455	133		
XA21712	132	AO19897	133	XC33492	133		
XA21713	132	AO19915	133	XC33553	133		
XA21715	132	AO19920	133	XC33571	133		
XA21740	132	AO19922	133	XC33574	133		
XA21785	132	AO19929	133	XC33584	133		
XA21800	132	AO19935	133	XC50054	133		
XA21801	132	AO19974	133	XC50062	133		
XA21813	132	AO19993	133	XC50088	133		
XA21814	132	AO20005	133	XC50089	133		
XA21821	132	AO20012	133	XC50102	133		
XA21828	132	AO20017	133	XC50125	133		
XA21835	132	AO20094	133	XC80037	133		
XA21836	132	XA50213	133	XC80254	133		
XA21837	132	XC00327	133	XC80312	133		
XA21840	132	XC00355	133	XC80355	133		
XA21921	132	XC00384	133	XC80358	133		
XA21950	132	XC00386	133	XE03427	133		
V8.540		XC21723	133	XE03428	133		
AO19030	133	XC21942	133	XE03429	133		
AO19053	133	XC21943	133	XE30072	133		
AO19139	133	XC21944	133	XE30085	133		
AO19153	133	XC21945	133	XE30099	133		
AO19162	133	XC22006	133	XE30123	133		
AO19176	133	XC22026	133	XE31102	133		
AO19177	133	XC22150	133	XE33176	133		
AO19180	133	XC22171	133	XE33216	133		
AO19189	133	XC22191	133	XE33222	133		
AO19190	133	XC22200	133	XE33227	133		
AO19225	133	XC22209	133	XE33442	133		
AO19241	133	XC22272	133	XE33484	133		
AO19256	133	XC22273	133	XE33491	133		
AO19261	133	XC22275	133	XE33501	133		



Quantity **21** 9



Quantity **21** 9

4.20		11	Industrial	81
4.99	10/69→	1	Industrial	84
1004-4T		64	Industrial	85
1004-4TW		63	Industrial	86
1006-6		129	Industrial	87
1006-6TW		131	Industrial	88
Agricultural		133	Industrial	89
Industrial		3	Industrial	90
Industrial		4	Industrial	91
Industrial		5	Industrial	92
Industrial		6	Industrial	93
Industrial		7	Industrial	94
Industrial		8	Industrial	95
Industrial		9	Industrial	96
Industrial		10	Industrial	97
Industrial		18	Industrial	98
Industrial		20	Industrial	99
Industrial		21	Industrial	100
Industrial		22	Industrial	101
Industrial		23	Industrial	102
Industrial		24	Industrial	103
Industrial		25	Industrial	104
Industrial		26	Industrial	105
Industrial		27	Industrial	106
Industrial		29	Industrial	107
Industrial		30	Industrial	108
Industrial		31	Industrial	109
Industrial		32	Industrial	110
Industrial		33	Industrial	111
Industrial		34	Industrial	112
Industrial		35	Industrial	113
Industrial		36	Industrial	114
Industrial		37	Industrial	115
Industrial		38	Industrial	116
Industrial		39	Industrial	117
Industrial		40	Industrial	118
Industrial		41	Industrial	119
Industrial		42	Industrial	120
Industrial		43	Industrial	121
Industrial		44	Industrial	122
Industrial		45	Industrial	123
Industrial		46	Industrial	124
Industrial		47	Industrial	125
Industrial		48	Industrial	126
Industrial		49	Industrial	127
Industrial		50	Industrial	128
Industrial		51	Industrial	130
Industrial		52	Industrial	132
Industrial		53	Industrial	133
Industrial		54	Industrial	01/61→ 2
Industrial		55	Industrial Flame Proof →U21038CL	14
Industrial		56	Industrial Flame Proof U21039CL→	13
Industrial		57	Industrial →U21038CL	15
Industrial		58	Industrial →U79697CL	19
Industrial		59	Industrial JG70156	28
Industrial		60	Industrial JG70162	28
Industrial		61	Industrial U21039CL→	16
Industrial		65	Industrial U21039CL→	17
Industrial		66	Marine	3
Industrial		67	Marine	4
Industrial		68	Marine	11
Industrial		69	Marine	12
Industrial		70	Phaser90	62
Industrial		71	Phaser 110T	64
Industrial		72	Phaser 120Ti	63
Industrial		73	Phaser 125	129
Industrial		74	Phaser 160T	01/89→ 130
Industrial		75	Phaser 180Ti	131
Industrial		76	Phaser 1004-4	62
Industrial		77	T4.20	12
Industrial		78	TG00360	82
Industrial		79	TG20563	83
Industrial		80	TG21219	83



21

9



21

9

TG21225	82
TG21301	83
TG21855	83
TG21915	83
TG21955	83
TG22271	83
TG22453	83
TG22550	83



cc



kW/PS

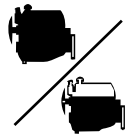

1	4.99	1621	4	76.20			AD920	CD920	ED920 [70] [69]
2	4.107	1760	4	79.37			AD920	CD920	
3	4.107	1760	4	79.37			AD920	CD920	ED920 [70] [69]
4	4.107	1760	4	79.37			AD920	CD920	ED923 [69]
5	4.107	1760	4	79.37			AD920	CD920	
6	4.108	1760	4	79.37			AH310	CH310	ED920 [70] [69]
7	4.108	1760	4	79.37			AH310	CH310	ED923 [69]
8	4.108	1760	4	79.37			AH310	CH310	
9	4.108	1760	4	79.37					ED920 [70] [69]
10	4.108	1760	4	79.37					ED923 [69]
11	Prima 65	1994	4	84.44			BP880	DP880 →09/92 DP882 10/92→	EM685
12	Prima 80T	1994	4	84.44	Turbo		BP880	DP881 →09/92 DP883 10/92→	EM685
13	3.152	2500	3	91.49	Indirect Injection		AE200	CE203 ○	EE203 ■ [67]
14	3.152	2500	3	91.49	Indirect Injection		AG130	CG131	EE203 ■ [67]
15	3.152	2500	3	91.49	Indirect Injection		AE200	CE203 ○	EE203 ■ [67]
16	3.152	2500	3	91.49	Indirect Injection				EE203 ■ [67]
17	3.152.2	2500	3	91.40			AG130	CG131	EE203 ■ [67]
18	3.152.4	2500	3	91.40	Indirect Injection		AG130	CG131	EE203 ■ [67]
19	D3.152	2500	3	91.40			AG130	CG131	EE203 ■ [67] Eng.U79698DL→ EE204 ■ [67] →Eng.U79698DL
20	D3.152	2500	3	91.49	Direct Injection		AE200	CE203 ○	EE203 ■ [67]
21	D3.152	2500	3	91.49	Direct Injection		AG130	CG131	
22	D3.152	2500	3	91.49	Direct Injection		AG130	CG131	EE203 ■ [67]
23	D3.152	2500	3	91.49	Direct Injection		AG130	CG131	EE205 ■ [67]
24	D3.152	2500	3	91.49	Direct Injection		AG130	CG131	EE204 ■ [67] →Eng.UA391044DL EE205 ■ [67] Eng.UA391045DL→
25	T3.152.4	2500	3	91.40	Turbo				EE205 ■ [67]

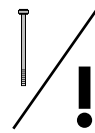
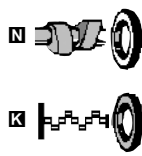
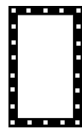
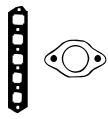

AD920

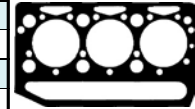

AE200



AG130



AH310



BP880



JJ315



JJ348

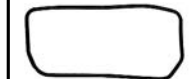

JM348

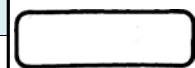

JM360

	JM360				
	JM360				
	JM360	HC064			
	JM360	HC064			
	JM360				
	JM360	HC064			
	JM360				
	JM360				
	JM360	HC064			
		JJ315	HR625 →09/92	N NB775 40x52x7mm, FPM N NB773 46x60x7mm, FPM K NB774 35x45x7mm, FPM K NB772 88.9x104.8x9.52mm, FPM	
		JJ315	HR625 →09/92	N NB775 40x52x7mm, FPM N NB773 46x60x7mm, FPM K NB774 35x45x7mm, FPM K NB772 88.9x104.8x9.52mm, FPM	
		JJ348		K NA736 57.15x76.2x12.7mm, Rubber K KT633 [17] (x2) K NB460 [63] 133.4x158.8x12.7mm, SIL	
			HR636	K NA736 57.15x76.2x12.7mm, Rubber K KT633 [17] (x2) K NB460 [63] 133.4x158.8x12.7mm, SIL	
				K NA736 57.15x76.2x12.7mm, Rubber K KT633 [17] (x2) K NB460 [63] 133.4x158.8x12.7mm, SIL	
				K NA736 57.15x76.2x12.7mm, Rubber K KT633 [17] (x2) K NB460 [63] 133.4x158.8x12.7mm, SIL	
			HR636	K NA736 57.15x76.2x12.7mm, Rubber K KT633 [17] (x2) K NB460 [63] 133.4x158.8x12.7mm, SIL	
			HR636	K NA736 57.15x76.2x12.7mm, Rubber K KT633 [17] (x2) K NB460 [63] 133.4x158.8x12.7mm, SIL	
			HR636	K NA736 57.15x76.2x12.7mm, Rubber K KT633 [17] (x2) K NB460 [63] 133.4x158.8x12.7mm, SIL	
	JM348			K NA736 57.15x76.2x12.7mm, Rubber K KT633 [17] (x2) K NB460 [63] 133.4x158.8x12.7mm, SIL	
			HR636	K NA736 57.15x76.2x12.7mm, Rubber K KT633 [17] (x2) K NB460 [63] 133.4x158.8x12.7mm, SIL	
			HR636	K NA736 57.15x76.2x12.7mm, Rubber K KT633 [17] (x2) K NB460 [63] 133.4x158.8x12.7mm, SIL	
			HR636	K NA736 57.15x76.2x12.7mm, Rubber K KT633 [17] (x2) K NB460 [63] 133.4x158.8x12.7mm, SIL	
			HR636	K NA736 57.15x76.2x12.7mm, Rubber K KT633 [17] (x2) K NB460 [63] 133.4x158.8x12.7mm, SIL	
				K NA736 57.15x76.2x12.7mm, Rubber K KT633 [17] (x2) K NB460 [63] 133.4x158.8x12.7mm, SIL	



cc



kW/PS

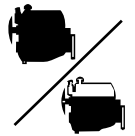

26	4.203	3300	4	91.40	Indirect Injection		AE810		EE812 ■ [67]
27	4.203	3300	4	91.40	Direct Injection		AE810	CE810 ○	EE812 ■ [67] Eng.U74103CL→
28	4.203.2	3300	4	91.40	Indirect Injection		AE920	CE922	
29	4.203.2	3300	4	91.40	Indirect Injection		AE920		
30	4.203.2	3300	4	91.49	Indirect Injection		AE920	CE922 ○	EE812 ■ [67]
31	D4.203	3300	4	91.40	Direct Injection		AE920	CE922 ○	EE812 ■ [67]
32	D4.203	3300	4	91.40	Direct Injection		AE920	CE922 ○	EE813 ■ [67]
33	D4.203	3300	4	91.49			AE920	CE920 ○	EE813 ■ [67]
34	G4.203	3300	4	91.40			AE920		EE812 ■ [67]
35	G4.203	3300	4	91.40			AE920		
36	4.212	3470	4	98.47			BK070	DK071 Eng.U106655N→ DK077 →Eng.U106654N	EH321 ■ [67]
37	4.212	3470	4	98.47			BK070	DK071	EF541 ■ [67]
38	4.212	3470	4	98.47			BK070	DK071	
39	G4.212	3470	4	98.47			BK070		
40	4.236	3866	4	98.47	Direct Injection		BK070	DK071 Eng.U106655N→ DK077 →Eng.U106654N	EF541 ■ [67]
41	4.236	3866	4	98.47	Direct Injection		BK070	DK071 Eng.U106655N→ DK077 →Eng.U106654N	
42	4.236	3866	4	98.47	Direct Injection		BK070	DK071 Eng.U106655N→ DK077 →Eng.U106654N	EF540 ■ [67]
43	4.236	3866	4	98.47	Direct Injection		BK070	DK077 →Eng.U106654N	EF541 ■ [67]
44	4.236	3866	4	98.47	Direct Injection		BK070	DK077 →Eng.U106654N	
45	4.236	3866	4	98.47	Direct Injection		BK070		EF541 ■ [67]
46	4.236	3866	4	98.47	Direct Injection		BK070	DK071 Eng.U1066545N→ DK077 →Eng.U106654N	EH321 ■ [67]
47	4.236	3866	4	98.47	Direct Injection		BK070	DK071 Eng.U106655N→ DK077 →Eng.U106654N	

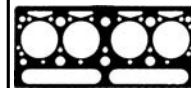
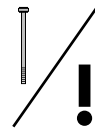
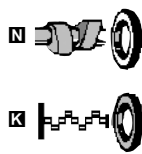
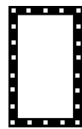
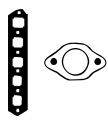

AE810



AE920

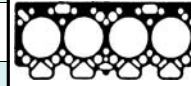

BK070



DK071

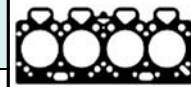

DK077



JM358



JN650

				<input checked="" type="checkbox"/> NA736 57.15x76.2x12.7mm, Rubber <input checked="" type="checkbox"/> KT633 [17] (x2) <input checked="" type="checkbox"/> NB460 [63] 133.4x158.8x12.7mm, SIL	
	JM358			<input checked="" type="checkbox"/> NA736 57.15x76.2x12.7mm, Rubber <input checked="" type="checkbox"/> KT633 [17] (x2) <input checked="" type="checkbox"/> NB460 [63] 133.4x158.8x12.7mm, SIL	
			HR637 [56]	<input checked="" type="checkbox"/> NA736 57.15x76.2x12.7mm, Rubber <input checked="" type="checkbox"/> NB460 [63] 133.4x158.8x12.7mm, SIL	
			HR637 [56]	<input checked="" type="checkbox"/> NA736 57.15x76.2x12.7mm, Rubber <input checked="" type="checkbox"/> NB460 [63] 133.4x158.8x12.7mm, SIL	
			HR637 [56]	<input checked="" type="checkbox"/> NA736 57.15x76.2x12.7mm, Rubber <input checked="" type="checkbox"/> NB460 [63] 133.4x158.8x12.7mm, SIL	
			HR637 [56]	<input checked="" type="checkbox"/> NA736 57.15x76.2x12.7mm, Rubber <input checked="" type="checkbox"/> NB460 [63] 133.4x158.8x12.7mm, SIL	
			HR637 [56]	<input checked="" type="checkbox"/> NA736 57.15x76.2x12.7mm, Rubber <input checked="" type="checkbox"/> NB460 [63] 133.4x158.8x12.7mm, SIL	
			HR637 [56]	<input checked="" type="checkbox"/> NA736 57.15x76.2x12.7mm, Rubber <input checked="" type="checkbox"/> KT633 [17] (x2) <input checked="" type="checkbox"/> NB460 [63] 133.4x158.8x12.7mm, SIL	
			HR637 [56]	<input checked="" type="checkbox"/> NA736 57.15x76.2x12.7mm, Rubber <input checked="" type="checkbox"/> KT633 [17] (x2) <input checked="" type="checkbox"/> NB460 [63] 133.4x158.8x12.7mm, SIL	
			HR637 [56]	<input checked="" type="checkbox"/> NA736 57.15x76.2x12.7mm, Rubber <input checked="" type="checkbox"/> NB460 [63] 133.4x158.8x12.7mm, SIL	
	JN650 Eng.U106654N →		HR639	<input checked="" type="checkbox"/> NB459 60.33x79.37x9.52mm, SIL <input checked="" type="checkbox"/> KT636 [17] (x2) <input checked="" type="checkbox"/> NB460 [63] 133.4x158.8x12.7mm, SIL	
			HR639	<input checked="" type="checkbox"/> NB459 60.33x79.37x9.52mm, SIL <input checked="" type="checkbox"/> KT636 [17] (x2) <input checked="" type="checkbox"/> NB460 [63] 133.4x158.8x12.7mm, SIL	
			HR639	<input checked="" type="checkbox"/> NB459 60.33x79.37x9.52mm, SIL <input checked="" type="checkbox"/> KT636 [17] (x2) <input checked="" type="checkbox"/> NB460 [63] 133.4x158.8x12.7mm, SIL	
			HR639	<input checked="" type="checkbox"/> NB459 60.33x79.37x9.52mm, SIL <input checked="" type="checkbox"/> KT636 [17] (x2) <input checked="" type="checkbox"/> NB460 [63] 133.4x158.8x12.7mm, SIL	
	JN650		HR639	<input checked="" type="checkbox"/> NB459 60.33x79.37x9.52mm, SIL <input checked="" type="checkbox"/> KT636 [17] (x2) <input checked="" type="checkbox"/> NB460 [63] 133.4x158.8x12.7mm, SIL	
	JN650		HR639	<input checked="" type="checkbox"/> NB459 60.33x79.37x9.52mm, SIL <input checked="" type="checkbox"/> NB460 [63] 133.4x158.8x12.7mm, SIL	
	JN650		HR639	<input checked="" type="checkbox"/> NB459 60.33x79.37x9.52mm, SIL <input checked="" type="checkbox"/> KT636 [17] (x2) <input checked="" type="checkbox"/> NB460 [63] 133.4x158.8x12.7mm, SIL	
	JN650		HR639	<input checked="" type="checkbox"/> NB459 60.33x79.37x9.52mm, SIL <input checked="" type="checkbox"/> NB460 [63] 133.4x158.8x12.7mm, SIL	
	JN650		HR639	<input checked="" type="checkbox"/> NB459 60.33x79.37x9.52mm, SIL <input checked="" type="checkbox"/> KT636 [17] (x2) <input checked="" type="checkbox"/> NB460 [63] 133.4x158.8x12.7mm, SIL	
	JN650		HR639	<input checked="" type="checkbox"/> NB459 60.33x79.37x9.52mm, SIL <input checked="" type="checkbox"/> NB460 [63] 133.4x158.8x12.7mm, SIL	
	JN650		HR639	<input checked="" type="checkbox"/> NB459 60.33x79.37x9.52mm, SIL <input checked="" type="checkbox"/> NB460 [63] 133.4x158.8x12.7mm, SIL	
	JN650		HR639	<input checked="" type="checkbox"/> NB459 60.33x79.37x9.52mm, SIL <input checked="" type="checkbox"/> NB460 [63] 133.4x158.8x12.7mm, SIL	



cc



kW/PS

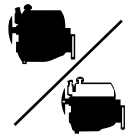

48	AT4.236	3866	4	98.47	Turbo		BK070 →Eng.U027773M BV910 Eng.U027774M→	DK077 →Eng.U027773M DV910 Eng.U027774M→	EH321 ■ [67]
49	C4.236	3866	4	98.47	Direct Injection		BV910 Eng.U390302U→	DV910 Eng.U390302U→	EH321 ■ [67]
50	C4.236	3866	4	98.47	Direct Injection		BK070 →Eng.U027773M BV910 Eng.U027774M→	DK077 →Eng.U027773M DV910 Eng.U027774M→	
51	C4.236	3866	4	98.47	Direct Injection		BK070 →Eng.U027773M BV910 Eng.U027774M→	DK077 →Eng.U027773M DV910 Eng.U027774M→	EK510 [67]
52	G4.236	3866	4	98.40			BK070	DK077 →Eng.U027773M	
53	G4.236	3866	4	98.40			BK070	DK077 →Eng.U106654N	EF541 ■ [67]
54	G4.236	3866	4	98.40			BK070 →Eng.U027774M		EF541 ■ [67]
55	G4.236	3866	4	98.40			BK070	DK077 →Eng.U106654N	EF540 ■ [67]
56	G4.236	3866	4	98.40			BK070	DK071 Eng.U106655N→ DK077 →Eng.U106654N	
57	T4.236	3866	4	98.47	Turbo		BK070 →Eng.U027773M BV910 Eng.U027774M→	DK077 →Eng.U027773M DV910 Eng.U027774M→	EH321 ■ [67]
58	T4.236	3866	4	98.47	Turbo		BK070 →Eng.U027773M BV910 Eng.U027774M→	DK077 →Eng.U027773M DV910 Eng.U027774M→	
59	T4.236	3866	4	98.47	Turbo		BK070 →Eng.U027773M BV910 Eng.U027774M→	DK077 →Eng.U027773M DV910 Eng.U027774M→	EK510 ■
60	T4.236	3866	4	98.47	Turbo		BK070 →Eng.U027773M BV910 Eng.U027774M→	DK077 →Eng.U027773M DV910 Eng.U027774M→	EF541 ■ [67]
61	T4.236	3866	4	98.47	Turbo		BK070 →Eng.U027773M BV910 Eng.U027774M→	DK077 →Eng.U027773M DV910 Eng.U027774M→	

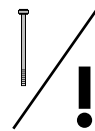
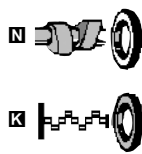
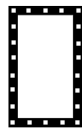
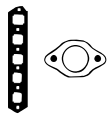

BK070

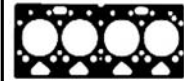

BV910

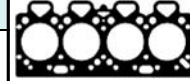

DK077



DV910



JN650

	JN650		HR639	<input checked="" type="checkbox"/> NB459 60.33x79.37x9.52mm, SIL <input checked="" type="checkbox"/> KT636 [17] (x2) <input checked="" type="checkbox"/> NB460 [63] 133.4x158.8x12.7mm, SIL	
	JN650		HR639	<input checked="" type="checkbox"/> NB459 60.33x79.37x9.52mm, SIL <input checked="" type="checkbox"/> KT636 [17] (x2) <input checked="" type="checkbox"/> NB460 [63] 133.4x158.8x12.7mm, SIL	
	JN650		HR639	<input checked="" type="checkbox"/> NB459 60.33x79.37x9.52mm, SIL <input checked="" type="checkbox"/> NB460 [63] 133.4x158.8x12.7mm, SIL	
	JN650		HR639	<input checked="" type="checkbox"/> NB459 60.33x79.37x9.52mm, SIL <input checked="" type="checkbox"/> NB460 [63] 133.4x158.8x12.7mm, SIL	
	JN650		HR639	<input checked="" type="checkbox"/> NB459 60.33x79.37x9.52mm, SIL <input checked="" type="checkbox"/> KT636 [17] (x2) <input checked="" type="checkbox"/> NB460 [63] 133.4x158.8x12.7mm, SIL	
	JN650		HR639	<input checked="" type="checkbox"/> NB459 60.33x79.37x9.52mm, SIL <input checked="" type="checkbox"/> KT636 [17] (x2) <input checked="" type="checkbox"/> NB460 [63] 133.4x158.8x12.7mm, SIL	
	JN650		HR639	<input checked="" type="checkbox"/> NB459 60.33x79.37x9.52mm, SIL <input checked="" type="checkbox"/> KT636 [17] (x2) <input checked="" type="checkbox"/> NB460 [63] 133.4x158.8x12.7mm, SIL	
	JN650		HR639	<input checked="" type="checkbox"/> NB459 60.33x79.37x9.52mm, SIL <input checked="" type="checkbox"/> KT636 [17] (x2) <input checked="" type="checkbox"/> NB460 [63] 133.4x158.8x12.7mm, SIL	
	JN650		HR639	<input checked="" type="checkbox"/> NB459 60.33x79.37x9.52mm, SIL <input checked="" type="checkbox"/> NB460 [63] 133.4x158.8x12.7mm, SIL	
	JN650		HR639	<input checked="" type="checkbox"/> NB459 60.33x79.37x9.52mm, SIL <input checked="" type="checkbox"/> NB460 [63] 133.4x158.8x12.7mm, SIL	
	JN650		HR639	<input checked="" type="checkbox"/> NB459 60.33x79.37x9.52mm, SIL <input checked="" type="checkbox"/> NB460 [63] 133.4x158.8x12.7mm, SIL	
	JN650		HR639	<input checked="" type="checkbox"/> NB459 60.33x79.37x9.52mm, SIL <input checked="" type="checkbox"/> NB460 [63] 133.4x158.8x12.7mm, SIL	
	JN650		HR639	<input checked="" type="checkbox"/> NB459 60.33x79.37x9.52mm, SIL <input checked="" type="checkbox"/> NB460 [63] 133.4x158.8x12.7mm, SIL	
	JN650		HR639	<input checked="" type="checkbox"/> NB459 60.33x79.37x9.52mm, SIL <input checked="" type="checkbox"/> NB460 [63] 133.4x158.8x12.7mm, SIL	
	JN650		HR639	<input checked="" type="checkbox"/> NB459 60.33x79.37x9.52mm, SIL <input checked="" type="checkbox"/> NB460 [63] 133.4x158.8x12.7mm, SIL	

PERKINS









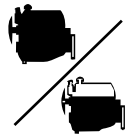



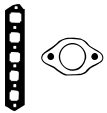

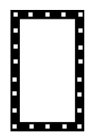

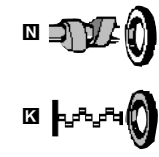
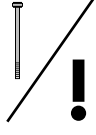





























































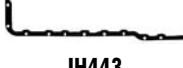





























































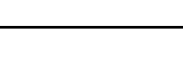













cc



kW/PS



62	4.40	3990	4	100.00	Normally Aspirated		BV570	DV571	EV570 ■ [67] EV571
63	C4.40	3990	4	100.00	Turbo & Intercooled		BV570	DV571	EV570 ■ [67] EV571
64	T4.40	3990	4	100.00	Turbo		BV570	DV571	EV570 ■ [67] EV571
65	4.248	4065	4	101.00			BK070	DK071	EF541 ■ [67]
66	4.248	4065	4	101.00			BK070	DK071	EH321 ■ [67]
67	4.248	4065	4	101.00			BK070	DK071	EF540 ■ [67]
68	4.248	4065	4	101.00			BK070	DK071	
69	4.248	4065	4	101.00			BK070		EH321 ■ [67]
70	4.248.2	4065	4	101.00			BK070	DK077 →Eng.U10896N	
71	4.248.2	4065	4	101.00			BK070	DK071	
72	6.306	5800	6	91.40			AH300	CH301	EH301 ■ [67]
73	6.354	5800	6	98.47	Direct Injection		AH300	CH301	
74	6.354	5800	6	98.47	Direct Injection		AH300		EH301 ■ [67]
75	6.354	5800	6	98.47	Direct Injection		AH300		EH301 ■ [67]
76	6.354	5800	6	98.47	Direct Injection		AH300		EH302 ■ [67]
77	6.354	5800	6	98.47	Direct Injection		AH300		
78	6.354	5800	6	98.47	Direct Injection		AH300	CH301	EH301 ■ [67]
79	6.354	5800	6	98.47	Direct Injection		AH300	CH301	EH302 ■ [67]
80	6.354	5800	6	98.47	Direct Injection		AH300	CH301	
81	6.354	5800	6	98.47	Direct Injection		AH300	CH301	

     							
	JN826		HR639 	 NB932  60x79.25x9mm FPM  NB933  133.4x158.8x11.1mm FPM			 <p>AH300</p> 
			HR639 	 NB932  60x79.25x9mm FPM  NB933  133.4x158.8x11.1mm FPM			 <p>BK070</p> 
	JN826		HR639 	 NB932  60x79.25x9mm FPM  NB933  133.4x158.8x11.1mm FPM			
	JN650		HR639 	 NB459  60.33x79.37x9.52mm, SIL  KT636  [17] (x2)  NB460  [63] 133.4x158.8x12.7mm, SIL			
	JN650		HR639 	 NB459  60.33x79.37x9.52mm, SIL  KT636  [17] (x2)  NB460  [63] 133.4x158.8x12.7mm, SIL			<p>BV570</p> 
	JN650		HR639 	 NB459  60.33x79.37x9.52mm, SIL  KT636  [17] (x2)  NB460  [63] 133.4x158.8x12.7mm, SIL			
	JN650		HR639 	 NB459  60.33x79.37x9.52mm, SIL  KT636  [17] (x2)  NB460  [63] 133.4x158.8x12.7mm, SIL			<p>DK071</p> 
	JN650		HR639 	 NB459  60.33x79.37x9.52mm, SIL  NB460  [63] 133.4x158.8x12.7mm, SIL			
	JN650		HR639 	 NB459  60.33x79.37x9.52mm, SIL  NB460  [63] 133.4x158.8x12.7mm, SIL			<p>DK077</p> 
				 NB459  60.33x79.37x9.52mm, SIL  KT636  [17] (x2)  NB460  [63] 133.4x158.8x12.7mm, SIL			
	JM393	JH443	HR638 	 NB459  60.33x79.37x9.52mm, SIL  KT636  [17] (x2)  NB460  [63] 133.4x158.8x12.7mm, SIL			<p>DV571</p> 
	JM393	JH443	HR638 	 NB459  60.33x79.37x9.52mm, SIL  KT636  [17] (x2)  NB460  [63] 133.4x158.8x12.7mm, SIL			
		JH443	HR638 	 NB459  60.33x79.37x9.52mm, SIL  KT636  [17] (x2)  NB460  [63] 133.4x158.8x12.7mm, SIL			<p>JH443</p> 
	JM393	JH443	HR638 	 NB459  60.33x79.37x9.52mm, SIL  KT636  [17] (x2)  NB460  [63] 133.4x158.8x12.7mm, SIL			
	JM393	JH443	HR638 	 NB459  60.33x79.37x9.52mm, SIL  KT636  [17] (x2)  NB460  [63] 133.4x158.8x12.7mm, SIL			<p>JM393</p> 
			HR638 	 NB459  60.33x79.37x9.52mm, SIL  KT636  [17] (x2)  NB460  [63] 133.4x158.8x12.7mm, SIL			
	JM393	JH443	HR638 	 NB459  60.33x79.37x9.52mm, SIL  KT636  [17] (x2)  NB460  [63] 133.4x158.8x12.7mm, SIL			<p>JN650</p> 
	JM393	JH443	HR638 	 NB459  60.33x79.37x9.52mm, SIL  KT636  [17] (x2)  NB460  [63] 133.4x158.8x12.7mm, SIL			
	JM393	JH443	HR638 	 NB459  60.33x79.37x9.52mm, SIL  KT636  [17] (x2)  NB460  [63] 133.4x158.8x12.7mm, SIL			<p>JN826</p> 
	JM393		HR638 	 NB459  60.33x79.37x9.52mm, SIL  KT636  [17] (x2)  NB460  [63] 133.4x158.8x12.7mm, SIL			

PERKINS



cc



kW/PS

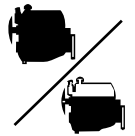

82	6.354.1	5800	6	98.47			BB240	DB240 ○	EH301 ■ [67]
83	6.354.1	5800	6	98.47			BB240	DB240 ○	EH302 ■ [67]
84	6.354.1	5800	6	98.47			BB240	DB240 ○	
85	6.354.1	5800	6	98.47			BB240		EH301 ■ [67]
86	6.354.1	5800	6	98.47			BB240		EH302 ■ [67]
87	6.354.2	5800	6	98.47	Direct Injection		AX940	CX941 ○	EH301 ■ [67]
88	6.354.2	5800	6	98.47	Direct Injection		AX940	CX941 ○	EH302 ■ [67]
89	6.354.2	5800	6	98.47	Direct Injection		AX940	CX941 ○	
90	6.354.2	5800	6	98.47	Direct Injection		AX940	CX941 ○	
91	6.354.2	5800	6	98.47	Direct Injection		AX940		EH301 ■ [67]
92	6.354.2	5800	6	98.47	Direct Injection		AX940		EH302 ■ [67]
93	6.354.2	5800	6	98.47	Direct Injection		AX940		
94	6.354.4	5800	6	98.47			BN370		EH305 ■ [67]
95	6.354.4	5800	6	98.47			BN370	DN370 ○	EH301 ■ [67]
96	6.354.4	5800	6	98.47			BN370	DN370 ○	EH302 ■ [67]
97	6.354.4	5800	6	98.47			BN370	DN370 ○	
98	6.354.4	5800	6	98.47			BN370	DN370 ○	EH305 ■ [67]
99	6.354.4	5800	6	98.47			BN370	DN370 ○	
100	6.354.4	5800	6	98.47			BN370	DN376	EH305 ■ [67]
101	6.354.4	5800	6	98.47			BN370	DN376	
102	6.354.4	5800	6	98.47			BN370	DN370 ○	
103	6.354.4, T6.354.4	5800	6	98.47	Normally Aspirated & Turbo		BN370		
104	6.354.4, T6.354.4	5800	6	98.47	Normally Aspirated & Turbo		BN370		EH305 ■ [67]
105	6.354.4, T6.354.4	5800	6	98.47	Normally Aspirated & Turbo		BN370	DN370 ○	
106	6.354.4, T6.354.4	5800	6	98.47	Normally Aspirated & Turbo		BN370		

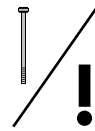
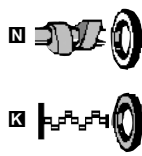
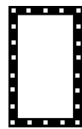
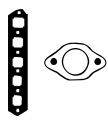

AX940



BB240



BN370



DN376



JH443



JM393



JN215

		JH443	HR638	<input checked="" type="checkbox"/> NB459 60.33x79.37x9.52mm, SIL <input checked="" type="checkbox"/> KT636 [17] (x2) <input checked="" type="checkbox"/> NB460 [63] 133.4x158.8x12.7mm, SIL	
		JH443	HR638	<input checked="" type="checkbox"/> NB459 60.33x79.37x9.52mm, SIL <input checked="" type="checkbox"/> KT636 [17] (x2) <input checked="" type="checkbox"/> NB460 [63] 133.4x158.8x12.7mm, SIL	
		JH443	HR638	<input checked="" type="checkbox"/> NB459 60.33x79.37x9.52mm, SIL <input checked="" type="checkbox"/> KT636 [17] (x2) <input checked="" type="checkbox"/> NB460 [63] 133.4x158.8x12.7mm, SIL	
		JH443	HR638	<input checked="" type="checkbox"/> NB459 60.33x79.37x9.52mm, SIL <input checked="" type="checkbox"/> KT636 [17] (x2) <input checked="" type="checkbox"/> NB460 [63] 133.4x158.8x12.7mm, SIL	
		JH443	HR638	<input checked="" type="checkbox"/> NB459 60.33x79.37x9.52mm, SIL <input checked="" type="checkbox"/> KT636 [17] (x2) <input checked="" type="checkbox"/> NB460 [63] 133.4x158.8x12.7mm, SIL	
		JH443	HR638	<input checked="" type="checkbox"/> NB459 60.33x79.37x9.52mm, SIL <input checked="" type="checkbox"/> KT636 [17] (x2) <input checked="" type="checkbox"/> NB460 [63] 133.4x158.8x12.7mm, SIL	
		JH443	HR638	<input checked="" type="checkbox"/> NB459 60.33x79.37x9.52mm, SIL <input checked="" type="checkbox"/> KT636 [17] (x2) <input checked="" type="checkbox"/> NB460 [63] 133.4x158.8x12.7mm, SIL	
		JH443	HR638	<input checked="" type="checkbox"/> NB459 60.33x79.37x9.52mm, SIL <input checked="" type="checkbox"/> KT636 [17] (x2) <input checked="" type="checkbox"/> NB460 [63] 133.4x158.8x12.7mm, SIL	
		JH443	HR638	<input checked="" type="checkbox"/> NB459 60.33x79.37x9.52mm, SIL <input checked="" type="checkbox"/> KT636 [17] (x2) <input checked="" type="checkbox"/> NB460 [63] 133.4x158.8x12.7mm, SIL	
		JH443	HR638	<input checked="" type="checkbox"/> NB459 60.33x79.37x9.52mm, SIL <input checked="" type="checkbox"/> KT636 [17] (x2) <input checked="" type="checkbox"/> NB460 [63] 133.4x158.8x12.7mm, SIL	
	JM393	JH443	HR638	<input checked="" type="checkbox"/> NB459 60.33x79.37x9.52mm, SIL <input checked="" type="checkbox"/> NB460 [63] 133.4x158.8x12.7mm, SIL	
	JN215	JH443	HR638	<input checked="" type="checkbox"/> NB459 60.33x79.37x9.52mm, SIL <input checked="" type="checkbox"/> KT636 [17] (x2) <input checked="" type="checkbox"/> NB460 [63] 133.4x158.8x12.7mm, SIL	
	JN215	JH443	HR638	<input checked="" type="checkbox"/> NB459 60.33x79.37x9.52mm, SIL <input checked="" type="checkbox"/> NB460 [63] 133.4x158.8x12.7mm, SIL	
	JN215	JH443	HR638	<input checked="" type="checkbox"/> NB459 60.33x79.37x9.52mm, SIL <input checked="" type="checkbox"/> NB460 [63] 133.4x158.8x12.7mm, SIL	
	JN215	JH443	HR638	<input checked="" type="checkbox"/> NB459 60.33x79.37x9.52mm, SIL <input checked="" type="checkbox"/> NB460 [63] 133.4x158.8x12.7mm, SIL	
	JN215		HR638	<input checked="" type="checkbox"/> NB459 60.33x79.37x9.52mm, SIL <input checked="" type="checkbox"/> NB460 [63] 133.4x158.8x12.7mm, SIL	
	JN215	JH443	HR638	<input checked="" type="checkbox"/> NB459 60.33x79.37x9.52mm, SIL <input checked="" type="checkbox"/> NB460 [63] 133.4x158.8x12.7mm, SIL	
	JN215	JH443	HR638	<input checked="" type="checkbox"/> NB459 60.33x79.37x9.52mm, SIL <input checked="" type="checkbox"/> NB460 [63] 133.4x158.8x12.7mm, SIL	
	JN215	JH443	HR638	<input checked="" type="checkbox"/> NB459 60.33x79.37x9.52mm, SIL <input checked="" type="checkbox"/> NB460 [63] 133.4x158.8x12.7mm, SIL	
	JN215	JH443	HR638	<input checked="" type="checkbox"/> NB459 60.33x79.37x9.52mm, SIL <input checked="" type="checkbox"/> NB460 [63] 133.4x158.8x12.7mm, SIL	
	JN215	JH443	HR638	<input checked="" type="checkbox"/> NB459 60.33x79.37x9.52mm, SIL <input checked="" type="checkbox"/> NB460 [63] 133.4x158.8x12.7mm, SIL	
	JN215	JH443	HR638	<input checked="" type="checkbox"/> NB459 60.33x79.37x9.52mm, SIL <input checked="" type="checkbox"/> NB460 [63] 133.4x158.8x12.7mm, SIL	

PERKINS



cc



kW/PS

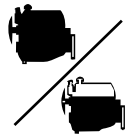

107	C6.354.4	5800	6	98.47	Turbo		BN370	DN371 ○	EH305 ■ [67]
108	H6.354	5800	6	98.47	Direct Injection		AH300		
109	H6.354.4	5800	6	98.47	Naturally Aspirated		BN370		
110	HT6.354	5800	6	98.40	Turbo		AH300		
111	T6.354	5800	6	98.40	Turbo		AH300		EH301 ■ [67]
112	T6.354	5800	6	98.40	Turbo		AH300		EH302 ■ [67]
113	T6.354	5800	6	98.40	Turbo		AH300		EH301 ■ [67]
114	T6.354.1	5800	6	98.47	Turbo		BB240	DB240 ○	EH301 ■ [67]
115	T6.354.1	5800	6	98.47	Turbo		BB240	DB240 ○	EH302 ■ [67]
116	T6.354.1	5800	6	98.47	Turbo		BB240	DB240 ○	
117	T6.354.1	05800	6	98.47	Turbo		BB240		EH301 ■ [67]
118	T6.354.1	5800	6	98.47	Turbo		BB240		EH302 ■ [67]
119	T6.354.4	5800	6	98.47	Turbo		BN370	DN371 ○	
120	T6.354.4	5800	6	98.47	Turbo		BN370	DN371 ○	EH305 ■ [67]
121	T6.354.4	5800	6	98.47	Turbo		BN370	DN371 ○	
122	T6.354.4	5800	6	98.47	Turbo		BN370		
123	T6.354.4	5800	6	98.47	Turbo		BN370		
124	T6.354.4	5800	6	98.47	Turbo		BN370		EH305 ■ [67]
125	T6.354.4	5800	6	98.47	Turbo		BN370	DN376	EH305 ■ [67]
126	T6.354.4	5800	6	98.47	Turbo		BN370	DN376	
127	T6.354.4	5800	6	98.47	Turbo		BN370	DN376	EH305 ■ [67]
128	T6.354.4	5800	6	98.47	Turbo		BN370	DN371 ○	EH302 ■ [67]

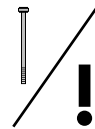
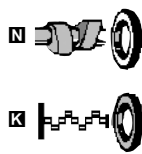
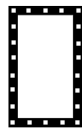
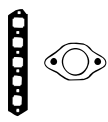

AH300



BB240



BN370



JH443



JM393



JN215

	JN215	JH443	HR638	NB459 60.33x79.37x9.52mm, SIL NB460 [63] 133.4x158.8x12.7mm, SIL	
	JM393		HR638	NB459 60.33x79.37x9.52mm, SIL KT636 [17] (x2) NB460 [63] 133.4x158.8x12.7mm, SIL	
	JN215		HR638	NB459 60.33x79.37x9.52mm, SIL NB460 [63] 133.4x158.8x12.7mm, SIL	
	JM393		HR638	NB459 60.33x79.37x9.52mm, SIL KT636 [17] (x2) NB460 [63] 133.4x158.8x12.7mm, SIL	
	JM393	JH443	HR638	NB459 60.33x79.37x9.52mm, SIL KT636 [17] (x2) NB460 [63] 133.4x158.8x12.7mm, SIL	
	JM393	JH443	HR638	NB459 60.33x79.37x9.52mm, SIL KT636 [17] (x2) NB460 [63] 133.4x158.8x12.7mm, SIL	
		JH443	HR638	NB459 60.33x79.37x9.52mm, SIL KT636 [17] (x2) NB460 [63] 133.4x158.8x12.7mm, SIL	
		JH443	HR638	NB459 60.33x79.37x9.52mm, SIL KT636 [17] (x2) NB460 [63] 133.4x158.8x12.7mm, SIL	
		JH443	HR638	NB459 60.33x79.37x9.52mm, SIL KT636 [17] (x2) NB460 [63] 133.4x158.8x12.7mm, SIL	
		JH443	HR638	NB459 60.33x79.37x9.52mm, SIL KT636 [17] (x2) NB460 [63] 133.4x158.8x12.7mm, SIL	
		JH443	HR638	NB459 60.33x79.37x9.52mm, SIL KT636 [17] (x2) NB460 [63] 133.4x158.8x12.7mm, SIL	
	JN215	JH443	HR638	NB459 60.33x79.37x9.52mm, SIL NB460 [63] 133.4x158.8x12.7mm, SIL	
	JN215	JH443	HR638	NB459 60.33x79.37x9.52mm, SIL NB460 [63] 133.4x158.8x12.7mm, SIL	
	JN215		HR638	NB459 60.33x79.37x9.52mm, SIL NB460 [63] 133.4x158.8x12.7mm, SIL	
	JN215	JH443	HR638	NB459 60.33x79.37x9.52mm, SIL NB460 [63] 133.4x158.8x12.7mm, SIL	
	JN215	JH443	HR638	NB459 60.33x79.37x9.52mm, SIL NB460 [63] 133.4x158.8x12.7mm, SIL	
	JN215	JH443	HR638	NB459 60.33x79.37x9.52mm, SIL NB460 [63] 133.4x158.8x12.7mm, SIL	
	JN215	JH443	HR638	NB459 60.33x79.37x9.52mm, SIL KT636 [17] (x2) NB460 [63] 133.4x158.8x12.7mm, SIL	
	JN215	JH443	HR638	NB459 60.33x79.37x9.52mm, SIL NB460 [63] 133.4x158.8x12.7mm, SIL	
		JH443		NB459 60.33x79.37x9.52mm, SIL KT636 [17] (x2) NB460 [63] 133.4x158.8x12.7mm, SIL	
	JN215	JH443	HR638	NB459 60.33x79.37x9.52mm, SIL NB460 [63] 133.4x158.8x12.7mm, SIL	

PERKINS



cc





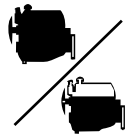





kW/PS



129	1006-6	5985	6	100.00	Normally Aspirated		BR530	DR530	ER530 [67] ER531
130	1006-6T	5985	6	100.00	Turbo		BR530	DR530	ER530 [67] ER531
131	CC6.60	5985	6	100.00	Turbo & Intercooled		BR530	DR530	ER530 [67] ER531
132	V8.510/AV8.510	8360	8	107.95	Direct Injection		BS250 (x2)		
133	V8.540	8830	8	107.95	Direct Injection		BS250 (x2)		

	JN826		HR638	<input checked="" type="checkbox"/> NB932 60x79.25x9mm FPM <input checked="" type="checkbox"/> NB933 133.4x158.8x11.1mm FPM		BR530	JN826
	JN826		HR638	<input checked="" type="checkbox"/> NB932 60x79.25x9mm FPM <input checked="" type="checkbox"/> NB933 133.4x158.8x11.1mm FPM			
			HR638	<input checked="" type="checkbox"/> NB932 60x79.25x9mm FPM <input checked="" type="checkbox"/> NB933 133.4x158.8x11.1mm FPM <input checked="" type="checkbox"/> NB459 60.33x79.37x9.52mm, SIL			BS250
			HR639	<input checked="" type="checkbox"/> NB459 60.33x79.37x9.52mm, SIL <input checked="" type="checkbox"/> NB460 [63] 133.4x158.8x12.7mm, SIL			

		cc			9			cc			9
712	Diesel	3320	4	98.00	10	MIDR 06.20.45 C/4	Diesel	9839	6	120.00	45
712-01-03	Diesel	3320	4	98.00	10	MIDR 06.20.45 D	Diesel	9839	6	120.00	49
712-01-04	Diesel	3320	4	98.00	10	MIDR 06.20.45 D/41	Diesel	9839	6	120.00	50
720	Diesel	3590	4	102.00	11	MIDR 06.20.45 D3	Diesel	9839	6	120.00	51
720-12	Diesel	3590	4	102.00	11	MIDR 06.20.45 E	Diesel	9839	6	120.00	48
797	Diesel	5453	6	102.00	15	MIDR 06.20.45 E/41	Diesel	9839	6	120.00	53
797 NFA	Diesel	5491	6	102.00	22	MIDR 06.20.45 E2	Diesel	9839	6	120.00	52
797-20	Diesel	5490	6	102.00	17	MIDR 06.20.45 E3	Diesel	9839	6	120.00	54
797-21	Diesel	5453	6	102.00	15	MIDR 06.20.45 F3	Diesel	9840	6	120.00	56
797-26	Diesel	5490	6	102.00	17	MIDR 06.20.45 H	Diesel	9839	6	120.00	52
798	Diesel	5490	6	102.00	19	MIDR 06.20.45 I3	Diesel	9840	6	120.00	56
798-10	Diesel	5490	6	102.00	19	MIDR 06.20.45 I41	Diesel	9840	6	120.00	56
798-13	Diesel	5490	6	102.00	19	MIDR 06.20.45 J3	Diesel	9800	6	120.00	43
798-20	Diesel	5490	6	102.00	19	MIDR 06.20.45 K	Diesel	9840	6	120.00	56
8140.23.2585	Diesel	2800	4	94.40	6	MIDR 06.20.45 L	Diesel	9840	6	120.00	56
8140.27	Diesel	2499	4	93.00	1	MIDR 06.20.45 M	Diesel	9840	6	120.00	56
8140.43.2585	Diesel	2800	4	94.40	8	MIDR 06.20.45 M3	Diesel	9840	6	120.00	56
8140.43.C.2586	Diesel	2800	4	94.40	7	MIDR 06.20.45 M41	Diesel	9839	6	120.00	44
8140.43.C.3586	Diesel	2800	4	94.40	7	MIDR 06.20.45 R41	Diesel	9839	6	120.00	44
8140.43.C.3588	Diesel	2800	4	94.40	7	MIDR 06.23.56 A/3	Diesel	11100	6	123.00	63
8140.43.S.2585	Diesel	2800	4	94.40	9	MIDR 06.23.56 A/41	Diesel	11100	6	123.00	63
8140.43.S.3585	Diesel	2800	4	94.40	9	MIDR 06.23.56 B/41	Diesel	11100	6	123.00	63
8140.43N.3585	Diesel	2798	4	94.40	4	MIDR 06.35.40	Diesel	12000	6	135.00	66
8140.47.2530 IDR	Diesel	2499	4	93.00	1	MIDR 06.35.40 C	Diesel	11941	6	135.00	64
8140.47.2585	Diesel	2499	4	93.00	2	MIDR 06.35.40 G	Diesel	12024	6	135.00	71
8140.47.2590	Diesel	2499	4	93.00	2	MIDR 06.35.40 H	Diesel	11941	6	135.00	65
8140.63.2585	Diesel	2800	4	94.40	5	MIDR 06.35.40 J/3	Diesel	12024	6	135.00	70
8140-43 k	Diesel	2800	4	94.40	9	MIDR 06.35.40 J1	Diesel	12024	6	135.00	70
8140-47	Diesel	2499	4	93.00	3	MIDR 06.35.40 L1	Diesel	12024	6	135.00	70
dCi 11C	Diesel	11100	6	123.00	62	MIDR 06.35.40 M3	Diesel	12024	6	135.00	70
dCi 11E	Diesel	11100	6	123.00	62	MIDR 06.35.40 N/3	Diesel	12024	6	135.00	70
dCi 11G	Diesel	11100	6	123.00	62	MIDR 06.35.40 P/41	Diesel	12024	6	135.00	72
dCi 4B	Diesel	4120	4	102.00	14	MIDS 06.02.12	Diesel	5490	6	102.00	18
dCi 4C	Diesel	4120	4	102.00	14	MIDS 06.02.12 B	Diesel	5453	6	102.00	16
dci 6A	Diesel	6177	6	102.00	27	MIDS 06.02.12 C	Diesel	5490	6	102.00	18
dci 6W	Diesel	6177	6	102.00	27	MIDS 06.02.12 D/3	Diesel	5490	6	102.00	20
M 520	Diesel	7917	5	120.00	33	MIDS 06.20.30	Diesel	8821	6	120.00	40
M 620 Z 3	Diesel	9500	6	120.00	41	MIDS 06.20.30 B	Diesel	8820	6	120.00	37
MDS 06.35.40	Diesel	12024	6	135.00	67	MIDS 06.20.30 D	Diesel	8820	6	120.00	37
MID 06.20.30 C	Diesel	8820	6	120.00	34	MIDS 06.20.30 E	Diesel	8820	6	120.00	37
MID 06.20.30 D	Diesel	8820	6	120.00	34	MIDS 06.20.30 K	Diesel	8820	6	120.00	37
MID 06.20.30 G	Diesel	8820	6	120.00	35	MIDS 06.20.30 N	Diesel	8820	6	120.00	38
MID 06.20.30 H	Diesel	8820	6	120.00	34	MIDS 06.20.30 N1	Diesel	8820	6	120.00	39
MID 06.20.45	Diesel	9840	6	120.00	56	MIDS 06.20.30 P	Diesel	8821	6	120.00	40
MIDR 04.02.26 A/4	Diesel	4120	4	102.00	13	MIDS 06.20.45	Diesel	9839	6	120.00	48
MIDR 04.02.26 A/41	Diesel	4100	4	102.00	12	MIDS 06.20.45 B	Diesel	9839	6	120.00	47
MIDR 04.02.26 B/4	Diesel	4120	4	102.00	13	MIDS 06.20.45 D	Diesel	9840	6	120.00	55
MIDR 04.02.26 B/41	Diesel	4100	4	102.00	12	MIDS 06.20.45 F	Diesel	9840	6	120.00	58
MIDR 06.02.12	Diesel	5491	6	102.00	23	MIDS 06.20.45 J3	Diesel	9840	6	120.00	59
MIDR 06.02.12 D	Diesel	5490	6	102.00	21	MIDS 06.35.40 D	Diesel	12024	6	135.00	69
MIDR 06.02.26	Diesel	6180	6	102.00	32	MIDS 06.35.40 E	Diesel	12024	6	135.00	68
MIDR 06.02.26 D	Diesel	6180	6	102.00	30	MIHR 06.20.45 A41	Diesel	9839	6	120.00	44
MIDR 06.02.26 H	Diesel	6178	6	102.00	29	MIP 06.20.30	Diesel	8820	6	120.00	36
MIDR 06.02.26 Q	Diesel	6180	6	102.00	31	MIPR 06.20.45 A	Diesel	9840	6	120.00	60
MIDR 06.02.26 S	Diesel	6174	6	102.00	25	MIPR 06.20.45 A3	Diesel	9840	6	120.00	61
MIDR 06.02.26 U	Diesel	6174	6	102.00	24	MIPR 06.20.45 B3	Diesel	9840	6	120.00	56
MIDR 06.02.26 U/4	Diesel	6180	6	102.00	30	MIPR 06.20.45 C3	Diesel	9840	6	120.00	56
MIDR 06.02.26 V	Diesel	6174	6	102.00	24	MIPS 06.20.30	Diesel	8820	6	120.00	36
MIDR 06.02.26 V/4	Diesel	6177	6	102.00	26	MIPS 06.20.45	Diesel	9840	6	120.00	57
MIDR 06.02.26 V/41	Diesel	6180	6	102.00	30	MIPS 06.20.45 A	Diesel	9840	6	120.00	56
MIDR 06.02.26 W	Diesel	6174	6	102.00	24	MIPS 06.20.45 B	Diesel	9840	6	120.00	56
MIDR 06.02.26 W/4	Diesel	6177	6	102.00	26	MIPS 06.20.45 C	Diesel	9840	6	120.00	56
MIDR 06.02.26 W/41	Diesel	6180	6	102.00	30						
MIDR 06.02.26 X	Diesel	6180	6	102.00	30						
MIDR 06.02.26 Y/41	Diesel	6177	6	102.00	28						
MIDR 06.20.30 A	Diesel	8820	6	120.00	39						
MIDR 06.20.30 B	Diesel	8820	6	120.00	37						
MIDR 06.20.30 C	Diesel	8820	6	120.00	37						
MIDR 06.20.45	Diesel	9771	6	120.00	42						
MIDR 06.20.45 A	Diesel	9839	6	120.00	46						
MIDR 06.20.45 A2	Diesel	9840	6	120.00	56						
MIDR 06.20.45 B3	Diesel	9839	6	120.00	48						
MIDR 06.20.45 C	Diesel	9840	6	120.00	56						



21

9



21

9

Agora Agora	01/96→	56	G G 210.17 BOM	11/83→02/90	38
Ares Ares		44	G G 210.17 BOM	11/83→02/90	39
C C 210.19	12/83→05/91	38	G G 210.18 BOM	11/83→02/90	38
C C 230ti.19	05/90→07/92	30	G G 210.18 BOM	11/83→02/90	39
C C 260.19	10/82→05/91	47	G G 210.19	11/83→02/90	38
C C 260.19,C 280.19	10/82→10/98	47	G G 210.19	11/83→02/90	39
C C 260.26	10/82→05/91	47	G G 210.19 BOM	11/83→02/90	38
C C 280.19	07/92→03/93	47	G G 210.19 BOM	11/83→02/90	39
C C 290.19,C 300.19	10/82→10/98	49	G G 220.17 BOM	03/91→09/91	58
C C 290.19,C 300.19	10/82→10/98	51	G G 220.19 BOM	03/91→09/91	58
C C 290.19/T	05/86→05/91	49	G G 230.11	01/85→05/90	40
C C 290.26,C 300.26	10/82→10/98	49	G G 230.13	01/85→05/90	40
C C 290.26,C 300.26	10/82→10/98	51	G G 230.13 SP	01/85→08/91	40
C C 300.19	04/87→10/98	49	G G 230.15	01/85→05/90	40
C C 300.19	04/87→10/98	51	G G 230.15/T	01/85→05/90	40
C C 300.24	04/87→10/98	49	G G 230.16	01/85→05/90	40
C C 300.24	04/87→10/98	51	G G 230.17	01/85→05/90	40
C C 300.26	04/87→10/98	49	G G 230.17/T	01/85→05/90	40
C C 300.26	04/87→10/98	51	G G 230.19	01/85→05/90	40
C C 340.19/T	07/90→10/98	48	G G 230ti.13	02/90→08/91	30
C C 340.19/T	07/90→10/98	52	G G 230ti.15	02/90→08/91	30
C C 340.19/T	07/90→10/98	54	G G 230ti.16	02/90→08/91	30
C C 340ti.17/T	07/90→10/98	48	G G 230ti.17	02/90→08/91	30
C C 340ti.17/T	07/90→10/98	52	G G 230ti.18	02/90→08/91	30
C C 340ti.17/T	07/90→10/98	54	G G 230ti.19	02/90→08/91	30
C C 340ti.19/T	07/90→10/98	48	G G 260.15/T	10/82→05/90	48
C C 340ti.19/T	07/90→10/98	52	G G 260.16	10/82→05/90	48
C C 340ti.19/T	07/90→10/98	54	G G 260.17	10/82→05/90	48
C CBH 280.26	04/86→10/92	69	G G 260.17	01/90→09/91	47
C CBH 280.26/T	04/86→10/92	69	G G 260.17/T	10/82→05/90	48
C CBH 280.34	04/86→10/92	69	G G 260.19	10/82→05/90	47
C CBH 280.34/T	04/86→10/92	69	G G 260.19	10/82→05/90	48
C CBH 320.24	10/92→10/98	70	G G 260.19/T	10/82→05/90	48
C CBH 320.24/T	10/92→10/98	70	G G 260.22/T	10/82→05/90	48
C CBH 320.26	10/92→10/98	70	G G 260.24 CIT	10/82→05/90	48
C CBH 320.26/T	10/92→10/98	70	G G 280.13	01/90→09/91	47
C CBH 320.34	10/92→10/98	70	G G 280.15	01/90→09/91	47
C CBH 320.34/T	10/92→10/98	70	G G 280.15/T	01/90→09/91	47
C CBH 340.26	02/88→10/92	71	G G 280.16	01/90→09/91	47
C CBH 350.26	05/90→01/93	71	G G 280.18	01/90→09/91	47
C CBH 350.34	05/90→01/93	71	G G 280.19	01/90→09/91	47
C CBH 380.26	01/90→10/92	65	G G 280.24	01/90→09/91	47
C CBH 380.34	01/90→10/92	65	G G 280.26	01/90→09/91	47
C CBH 385.24	10/92→10/98	70	G G 290.17/TD	11/85→12/89	42
C CBH 385.26	10/92→10/98	70	G G 290.19	11/85→12/89	42
C CBH 385.26/T	10/92→10/98	70	G G 290.19/T	11/85→12/89	42
C CBH 385.34	10/92→10/98	70	G G 290.22/TD	11/85→12/89	42
C CBH 385.34/T	10/92→10/98	70	G G 290.24	11/85→12/89	42
C CCH 300.26	09/90→03/93	49	G G 290.24 CIT	11/85→12/89	42
C CCH 300.30	09/90→03/93	49	G G 290.26	11/85→12/89	42
C CLM 280.19/T	04/86→10/92	69	G G 300.13	01/90→08/91	49
C CLM 320.19/T	10/92→10/98	70	G G 300.15	01/90→08/91	49
C CLM 320.25/T	10/92→10/98	70	G G 300.15/T	01/90→08/91	49
C CLM 380.19/T	05/91→10/92	65	G G 300.16	01/90→08/91	49
C CLM 385.19/T	10/92→10/98	70	G G 300.17	01/90→08/91	49
C CLM 385.22/T	10/92→10/98	70	G G 300.19	01/90→08/91	49
C CLM 385.25/T	10/92→10/98	70	G G 300.19/T	01/90→08/91	49
C CLR 230.19	09/90→10/98	30	G G 300.24	01/90→08/91	49
FR1 FR1	01/83→	49	G G 300.25	01/90→08/91	49
FR1 FR1	01/83→	51	G G 300.26	01/90→08/91	49
FR1 FR1	01/83→	56	G G 300.26 CIT	01/90→08/91	49
G G 170.11	05/83→02/90	21	G G 300.26/T	01/90→08/91	49
G G 170.13	05/83→02/90	21	G G 320.19	11/88→05/90	52
G G 170.15	05/83→02/90	21	G G 320.19 T	11/88→05/90	52
G G 170.16	05/83→02/90	21	G G 330.13	02/90→08/91	52
G G 170.17	05/83→02/90	21	G G 330.15	02/90→08/91	52
G G 200.13	05/90→09/91	29	G G 330.16	02/90→08/91	52
G G 200.15	05/90→09/91	29	G G 330.17	02/90→08/91	52
G G 200.16	05/90→09/91	29	G G 330.17/T	02/90→08/91	52
G G 200.17	05/90→09/91	29	G G 330.19	02/90→08/91	52
G G 200.18	05/90→09/91	29	G G 330.24	02/90→08/91	52
G G 210.16	11/83→02/90	38	G G 330.26	02/90→08/91	52
G G 210.16	11/83→02/90	39	G G 340ti.19/T,G 330.19/T	02/90→08/91	52



21

9

G G 340ti.19/T,G 330.19/T	02/90→08/91	54
G G 340ti.19/T,G 330.19/T,G 330.17/T	01/90→08/91	52
G G 340ti.19/T,G 330.19/T,G 330.17/T	01/90→08/91	54
G G 320	11/88→05/90	52
Iliade FRH, GTX, GTXE, RTX, TX	01/97→	63
Iliade GT, GTC, GTE	04/98→	44
Kerax 260.18	06/97→	45
Kerax 260.18/B	06/97→	45
Kerax 300.18/B	06/97→	50
Kerax 300.26/A,300.26/B	06/97→	50
Kerax 300.26/B	06/97→	50
Kerax 320.18	01/01→	62
Kerax 320.26	01/01→	62
Kerax 340.18	06/97→	53
Kerax 340.18/B	06/97→	53
Kerax 340.26	06/97→01/01	53
Kerax 340.26/A,340.26/B	06/97→	53
Kerax 340.26/B	06/97→	53
Kerax 340.32/A	06/97→	53
Kerax 350.34	01/03→	63
Kerax 370.18	01/01→	62
Kerax 370.26	01/01→	62
Kerax 370.32	01/01→	62
Kerax 385.18	06/97→	63
Kerax 385.18/B	06/97→	63
Kerax 385.18T	06/97→	63
Kerax 385.26	06/97→	63
Kerax 385.26/A,385.26/B	06/97→	63
Kerax 385.26/A,385.26/B,385.26/C	06/97→	63
Kerax 385.26/B	06/97→	63
Kerax 385.26T	06/97→	63
Kerax 385.32/A,385.32/B	06/97→	63
Kerax 385.32/A,385.32/B,385.32/C	06/97→	63
Kerax 385.32/B	06/97→	63
Kerax 400.18	01/00→	63
Kerax 400.18T	01/00→	63
Kerax 400.26	09/98→	63
Kerax 400.26/A,400.26/B,400.26/C	01/00→	63
Kerax 400.26/B	01/00→	63
Kerax 400.26T	01/00→	63
Kerax 400.32/A,400.32/B,400.32/C	01/00→	63
Kerax 400.32/B	01/00→	63
Kerax 420.18	01/01→	62
Kerax 420.26	01/01→	62
Kerax 420.32	10/01→	62
Kerax 420.34	01/01→	62
Magnum AE 385ti.18	02/92→10/96	70
Magnum AE 385ti.18T	02/92→10/96	70
Magnum AE 385ti.19	02/92→10/96	70
Magnum AE 385ti.19T	02/92→10/96	70
Magnum AE 385ti.24	02/92→10/96	70
Magnum AE 385ti.26	02/92→10/96	70
Magnum AE 420ti.18	10/92→12/96	70
Magnum AE 420ti.18	10/92→12/96	72
Magnum AE 420ti.18T	10/92→12/96	70
Magnum AE 420ti.18T	10/92→12/96	72
Magnum AE 420ti.19	10/92→12/96	70
Magnum AE 420ti.19	10/92→12/96	72
Magnum AE 420ti.19T	10/92→12/96	70
Magnum AE 420ti.19T	10/92→12/96	72
Magnum AE 420ti.22T	10/92→10/96	70
Magnum AE 420ti.22T	10/92→10/96	72
Magnum AE 420ti.24	10/92→12/96	70
Magnum AE 420ti.24	10/92→12/96	72
Magnum AE 420ti.24T	10/92→12/96	70
Magnum AE 420ti.24T	10/92→12/96	72
Magnum AE 420ti.26	10/92→12/96	70
Magnum AE 420ti.26	10/92→12/96	72
Magnum AE 420ti.26T	10/92→12/96	70
Magnum AE 420ti.26T	10/92→12/96	72
Major R 340ti.16/T	05/91→10/96	48
Major R 340ti.16/T	05/91→10/96	52
Major R 340ti.16/T	05/91→10/96	54



21

9

Major R 340ti.17	05/91→10/96	48
Major R 340ti.17	05/91→10/96	52
Major R 340ti.17	05/91→10/96	54
Major R 340ti.18	05/91→10/96	48
Major R 340ti.18	05/91→10/96	52
Major R 340ti.18	05/91→10/96	54
Major R 340ti.18/T	05/91→10/96	48
Major R 340ti.18/T	05/91→10/96	52
Major R 340ti.18/T	05/91→10/96	54
Major R 340ti.19	05/91→10/96	48
Major R 340ti.19	05/91→10/96	52
Major R 340ti.19/T	05/91→10/96	48
Major R 340ti.19/T	05/91→10/96	52
Major R 340ti.19/T	05/91→10/96	54
Major R 340ti.24	05/91→10/96	48
Major R 340ti.24	05/91→10/96	52
Major R 340ti.24	05/91→10/96	54
Major R 340ti.26	05/91→10/96	48
Major R 340ti.26	05/91→10/96	52
Major R 340ti.26	05/91→10/96	54
Major R 350.17	05/91→12/92	71
Major R 350.17/T	05/91→12/92	71
Major R 350.18	05/91→12/92	71
Major R 350.18/T	05/91→12/92	71
Major R 350.19	05/91→12/92	71
Major R 350.19/T	05/91→12/92	71
Major R 350.19/TB	05/91→12/92	71
Major R 350.24	05/91→10/92	71
Major R 350.26	05/91→12/92	71
Major R 380.22/T	05/91→12/92	65
Major R 380.25	05/91→12/92	65
Major R 385ti.17,R 380.17	05/91→10/96	65
Major R 385ti.17,R 380.17	05/91→10/96	70
Major R 385ti.18,R 380.18	05/91→10/96	65
Major R 385ti.18,R 380.18	05/91→10/96	70
Major R 385ti.18/T,R 380.18/T	05/91→10/96	65
Major R 385ti.18/T,R 380.18/T	05/91→10/96	70
Major R 385ti.19,R 380.19	05/91→10/96	65
Major R 385ti.19,R 380.19	05/91→10/96	70
Major R 385ti.19/T,R 380.19/T	05/91→10/96	65
Major R 385ti.19/T,R 380.19/T	05/91→10/96	70
Major R 385ti.22/T,R 380.19/TB	05/91→10/96	65
Major R 385ti.22/T,R 380.19/TB	05/91→10/96	70
Major R 385ti.24,R 380.24	05/91→10/96	65
Major R 385ti.24,R 380.24	05/91→10/96	70
Major R 385ti.25,R 380.25	05/91→10/96	65
Major R 385ti.25,R 380.25	05/91→10/96	70
Major R 385ti.25/T,R 380.25/T	05/91→10/96	65
Major R 385ti.25/T,R 380.25/T	05/91→10/96	70
Major R 385ti.26	12/91→10/96	70
Major R 385ti.26,R 380.26	05/91→10/96	65
Major R 385ti.26,R 380.26	05/91→10/96	70
Major R 385ti.26/T,R 380.26/T	05/91→10/96	65
Major R 385ti.26/T,R 380.26/T	05/91→10/96	70
Major R 420ti.18/T	10/92→10/96	70
Major R 420ti.19/T	10/92→10/96	70
Major R 420ti.22/T	10/92→10/96	70
Major R 420ti.24/TS	04/92→10/96	70
Major R 420ti.26/TS	04/92→10/96	70
Major R 420ti.35/TS	04/92→10/96	70
Manager G 200.13	09/91→03/93	29
Manager G 200.13	09/91→03/93	31
Manager G 200.15	09/91→03/93	29
Manager G 200.15	09/91→03/93	31
Manager G 200.16	09/91→03/93	29
Manager G 200.16	09/91→03/93	31
Manager G 200.17	09/91→03/93	29
Manager G 200.17	09/91→03/93	31
Manager G 200.18	09/91→03/93	29
Manager G 200.18	09/91→03/93	31
Manager G 210.16	05/92→10/96	24
Manager G 210.18	05/92→10/96	24



21

9



21

9

Manager G 220.17 BOM	09/91→10/96	58	Manager G 340ti.17,G 330.19	09/91→10/96	48
Manager G 220.17 BOM	09/91→10/96	59	Manager G 340ti.17,G 330.19	09/91→10/96	52
Manager G 220.19 BOM	09/91→10/96	58	Manager G 340ti.17,G 330.19	09/91→10/96	54
Manager G 220.19 BOM	09/91→10/96	59	Manager G 340ti.17/T,G 330.17/T	09/91→10/96	48
Manager G 230.13 SP	09/91→03/93	40	Manager G 340ti.17/T,G 330.17/T	09/91→10/96	52
Manager G 230ti.13	09/91→03/93	30	Manager G 340ti.17/T,G 330.17/T	09/91→10/96	54
Manager G 230ti.15	09/91→03/93	30	Manager G 340ti.18,G 330.18	09/91→10/96	48
Manager G 230ti.16	09/91→10/96	30	Manager G 340ti.18,G 330.18	09/91→10/96	52
Manager G 230ti.17	09/91→10/96	30	Manager G 340ti.18,G 330.18	09/91→10/96	54
Manager G 230ti.18	05/92→10/96	30	Manager G 340ti.18/T	02/92→10/96	48
Manager G 230ti.19	09/91→10/96	30	Manager G 340ti.18/T	02/92→10/96	52
Manager G 270.13 SP	03/93→10/96	48	Manager G 340ti.18/T	02/92→10/96	54
Manager G 270.14 SP	03/93→10/96	48	Manager G 340ti.19,G 330.19	09/91→10/96	48
Manager G 270.18,G 270.17	11/92→10/96	48	Manager G 340ti.19,G 330.19	09/91→10/96	52
Manager G 280.13,G 270.13	09/91→10/96	47	Manager G 340ti.19,G 330.19	09/91→10/96	54
Manager G 280.13,G 270.13	09/91→10/96	48	Manager G 340ti.19/T,G 330.19/T	09/91→10/96	48
Manager G 280.15,G 270.15	09/91→10/96	47	Manager G 340ti.19/T,G 330.19/T	09/91→10/96	52
Manager G 280.15,G 270.15	09/91→10/96	48	Manager G 340ti.19/T,G 330.19/T	09/91→10/96	54
Manager G 280.15/T,G 270.15/T	09/91→10/96	47	Manager G 340ti.19/T,G 330.19/T,G 330.17/T	09/91→10/96	48
Manager G 280.15/T,G 270.15/T	09/91→10/96	48	Manager G 340ti.19/T,G 330.19/T,G 330.17/T	09/91→10/96	52
Manager G 280.16	09/91→03/93	47	Manager G 340ti.19/T,G 330.19/T,G 330.17/T	09/91→10/96	54
Manager G 280.16,G 270.16	09/91→10/96	47	Manager G 340ti.26,G 330.26	10/91→10/96	52
Manager G 280.16,G 270.16	09/91→10/96	48	Manager G 340ti.26,G 330.26	10/91→10/96	54
Manager G 280.17,G 270.18	09/91→10/96	47	Mascott 150.35	10/01→06/04	4
Manager G 280.17,G 270.18	09/91→10/96	48	Mascott 150.55	10/01→06/04	4
Manager G 280.17/T,G 270.17/T	09/91→10/96	47	Mascott Mascott	01/01→06/04	9
Manager G 280.17/T,G 270.17/T	09/91→10/96	48	Mascott Mascott 90	01/99→12/01	5
Manager G 280.18,G 270.18,G 270.17	09/91→10/96	47	Mascott Mascott 90	01/00→06/04	7
Manager G 280.18,G 270.18,G 270.17	09/91→10/96	48	Mascott Mascott 110	01/99→06/04	7
Manager G 280.19	09/91→03/93	47	Mascott Mascott 130	01/99→06/04	9
Manager G 280.19,G 270.19	09/91→10/96	47	Mascott Mascott 140	01/01→06/04	9
Manager G 280.19,G 270.19	09/91→10/96	48	Maxter G 230ti.19	10/92→05/95	30
Manager G 280.24	09/91→03/93	47	Maxter G 260.19	02/96→06/97	45
Manager G 280.26,G 270.26	09/91→10/96	47	Maxter G 270.19	01/93→10/96	48
Manager G 280.26,G 270.26	09/91→10/96	48	Maxter G 280.18	10/92→03/93	47
Manager G 300.13	09/91→10/96	49	Maxter G 280.18/T	10/92→03/93	47
Manager G 300.13	09/91→10/96	51	Maxter G 300.18	10/92→10/96	49
Manager G 300.15	09/91→10/96	49	Maxter G 300.18	10/92→10/96	51
Manager G 300.15	09/91→10/96	51	Maxter G 300.19	10/92→10/96	49
Manager G 300.15/T	09/91→10/96	49	Maxter G 300.19	10/92→10/96	51
Manager G 300.15/T	09/91→10/96	51	Maxter G 300.19	02/96→06/97	50
Manager G 300.16	09/91→10/96	49	Maxter G 300.19/T	10/92→10/96	49
Manager G 300.16	09/91→10/96	51	Maxter G 300.19/T	10/92→10/96	51
Manager G 300.17	09/91→10/96	49	Maxter G 300.26	10/92→10/96	51
Manager G 300.17	09/91→10/96	51	Maxter G 300.26	02/96→06/97	50
Manager G 300.17/T	09/92→10/96	49	Maxter G 340ti.18/T	10/92→06/97	53
Manager G 300.17/T	09/92→10/96	51	Maxter G 340ti.18/T	10/92→06/97	54
Manager G 300.18	09/92→10/96	49	Maxter G 340ti.19	10/92→06/97	53
Manager G 300.18	09/92→10/96	51	Maxter G 340ti.19	10/92→06/97	54
Manager G 300.19	09/91→10/96	49	Maxter G 340ti.19/T	10/92→06/97	53
Manager G 300.19	09/91→10/96	51	Maxter G 340ti.19/T	10/92→06/97	54
Manager G 300.19/T	09/91→10/96	49	Maxter G 340ti.25/A,G 340ti.25/B	10/92→06/97	53
Manager G 300.19/T	09/91→10/96	51	Maxter G 340ti.25/A,G 340ti.25/B	10/92→06/97	54
Manager G 300.24	09/91→10/96	49	Maxter G 340ti.26	10/92→06/97	53
Manager G 300.24	09/91→10/96	51	Maxter G 340ti.26	10/92→06/97	54
Manager G 300.25	09/91→10/96	49	Maxter G 340ti.26,G 340ti.26/B	10/92→06/97	53
Manager G 300.25	09/91→10/96	51	Maxter G 340ti.26,G 340ti.26/B	10/92→06/97	54
Manager G 300.26	09/91→10/96	49	Maxter G 340ti.26/B	10/92→06/97	53
Manager G 300.26	09/91→10/96	51	Maxter G 340ti.26/B	10/92→06/97	54
Manager G 300.26 CIT	09/91→10/96	49	Maxter G 340ti.26/C	10/92→06/97	53
Manager G 300.26 CIT	09/91→10/96	51	Maxter G 340ti.26/C	10/92→06/97	54
Manager G 300.26/T	09/91→10/96	49	Maxter G 340ti.32,G 340ti.32/B	10/92→06/97	53
Manager G 300.26/T	09/91→10/96	51	Maxter G 340ti.32,G 340ti.32/B	10/92→06/97	54
Manager G 330.13	09/91→03/93	52	Maxter G 340ti.32/A,G 340ti.32/B,G 340ti.32/C	10/92→06/97	53
Manager G 330.15	09/91→03/93	52	Maxter G 340ti.32/A,G 340ti.32/B,G 340ti.32/C	10/92→06/97	54
Manager G 330.17	09/91→03/93	52	Maxter G 340ti.34	10/92→06/97	53
Manager G 330.18	09/91→03/93	52	Maxter G 340ti.34	10/92→06/97	54
Manager G 330.19	09/91→03/93	52	Maxter G 340ti.40	10/92→06/97	53
Manager G 330.24	09/91→03/93	52	Maxter G 340ti.40	10/92→06/97	54
Manager G 330.26	09/91→03/93	52	Messenger B 110.45	09/96→06/99	6
Manager G 340ti.16,G 330.16	09/91→10/96	48	Messenger B 120.35	10/91→07/96	1
Manager G 340ti.16,G 330.16	09/91→10/96	52	Messenger B 120.35	10/91→07/96	2
Manager G 340ti.16,G 330.16	09/91→10/96	54	Messenger B 120.35	09/96→06/99	8



21

9

Messenger B 120.55	01/94→09/96	2
Messenger B 120.55	09/96→06/99	8
Messenger B 120.55T	01/94→09/96	2
Messenger B 120.55T	09/96→06/99	8
Messenger B 120.65	01/94→09/96	2
Messenger B 120.65	09/96→06/99	8
Midliner M 140.12/C	05/89→03/93	18
Midliner M 140.13/C	04/89→03/93	18
Midliner M 150.09/C	11/92→10/96	24
Midliner M 150.09/C SP	11/92→10/96	24
Midliner M 150.11/C	11/92→10/96	24
Midliner M 150.11/C SP	11/92→10/96	24
Midliner M 150.12/C	11/92→01/00	30
Midliner M 150.12/C BTP	11/92→10/96	24
Midliner M 150.13/C	11/92→10/96	24
Midliner M 150.13/C	05/96→01/00	30
Midliner M 150.13/C BTP	11/92→10/96	24
Midliner M 150.14/C BOM	11/92→10/96	24
Midliner M 150.14/C CIT	11/92→10/96	24
Midliner M 160.12/C	05/89→03/93	16
Midliner M 160.13/C	05/89→03/93	16
Midliner M 160.14/C BOM	05/89→03/93	16
Midliner M 160.14/C CIT	05/89→03/93	16
Midliner M 160.15/D	05/89→03/93	16
Midliner M 180.10/C	11/92→10/96	24
Midliner M 180.11/C	11/92→10/96	24
Midliner M 180.11/C SP	11/92→10/96	24
Midliner M 180.12/C	11/92→10/96	24
Midliner M 180.12/C	05/96→01/00	30
Midliner M 180.12/C BTP	11/92→10/96	24
Midliner M 180.13 SP	11/92→10/96	24
Midliner M 180.13/C	11/92→10/96	24
Midliner M 180.13/C	05/96→01/00	30
Midliner M 180.13/C BTP	11/92→10/96	24
Midliner M 180.15/D	11/92→10/96	24
Midliner M 180.15/D	10/96→01/00	30
Midliner M 180.15/D BTP	11/92→10/96	24
Midliner M 180.16/D	11/92→10/96	24
Midliner M 180.16/D	05/96→01/00	30
Midliner M 200.10/C	05/88→03/93	29
Midliner M 200.12/C	05/88→03/93	29
Midliner M 200.13/C	05/88→03/93	29
Midliner M 200.14/C BOM	05/88→03/93	29
Midliner M 200.14/C CIT	05/88→03/93	29
Midliner M 200.15/D	05/88→03/93	29
Midliner M 200.16/D	05/88→03/93	29
Midliner M 210.12/C	05/92→01/00	24
Midliner M 210.12/C	05/92→01/00	30
Midliner M 210.13/C	05/92→01/00	24
Midliner M 210.13/C	05/92→01/00	30
Midliner M 210.13/C SP	05/92→10/96	24
Midliner M 210.14/C BOM	05/92→10/96	24
Midliner M 210.14/D	05/96→01/00	30
Midliner M 210.15/D	05/92→01/00	24
Midliner M 210.15/D	05/92→01/00	30
Midliner M 210.15/D CIT	05/92→10/96	24
Midliner M 210.16/D	05/92→01/00	24
Midliner M 210.16/D	05/92→01/00	30
Midliner M 210.16/D CIT	05/92→10/96	24
Midliner M 230.10/C	05/89→07/92	25
Midliner M 230.10/C	05/89→07/92	30
Midliner M 230.12/C	05/92→10/96	30
Midliner M 230.12/D	05/89→07/92	25
Midliner M 230.12/D	05/89→07/92	30
Midliner M 230.13/C	05/92→10/96	30
Midliner M 230.13/C,M 230.13/D	05/89→10/96	25
Midliner M 230.13/C,M 230.13/D	05/89→10/96	30
Midliner M 230.13/D	05/89→07/92	25
Midliner M 230.13/D	05/89→07/92	30
Midliner M 230.13C/T	05/89→10/96	25
Midliner M 230.13C/T	05/89→10/96	30
Midliner M 230.15/D	05/89→10/96	25
Midliner M 230.15/D	05/89→10/96	30



21

9

Midliner M 230.15/D CIT	05/89→07/92	25
Midliner M 230.15/D CIT	05/89→07/92	30
Midliner M 230.16/D	05/89→10/96	25
Midliner M 230.16/D	05/89→10/96	30
Midliner M 230.16/D CIT	05/89→07/92	25
Midliner M 230.16D/T	05/89→10/96	25
Midliner M 230.16D/T	05/89→10/96	30
Midliner M 250.13/C	05/96→01/00	28
Midliner M 250.15/C,M 250.15/D	05/96→01/00	28
Midliner M 250.15C/T	05/96→01/00	28
Midliner M 250.16/D	05/96→01/00	28
Midliner ME 160.13	05/89→03/93	16
Midliner ME 160.15	05/89→03/93	16
Midliner ME 180.15	05/89→03/93	21
Midliner S 110.06/A	06/85→09/90	15
Midliner S 110.07/A	06/85→09/90	15
Midliner S 110.08/A	06/85→09/90	15
Midliner S 130.06	09/83→01/90	15
Midliner S 130.07	09/83→01/90	15
Midliner S 130.08/A	09/83→01/90	15
Midliner S 130.08/A,S 130.08/B	09/83→01/90	15
Midliner S 130.08/B	09/83→01/90	15
Midliner S 130.08/R	09/83→01/90	15
Midliner S 130.09/B	09/83→01/90	15
Midliner S 130.11	09/83→01/90	15
Midliner S 130.11/B	09/83→01/90	15
Midliner S 130.13/B	09/83→01/90	15
Midliner S 135.08/A,S 150.08/A	05/96→01/00	12
Midliner S 135.09/B,S 150.09/B	05/96→01/00	12
Midliner S 140.07/A	01/90→09/93	18
Midliner S 140.08/A,S 140.08/B	01/90→09/93	18
Midliner S 140.08/B	01/90→09/93	18
Midliner S 140.09/B	01/90→09/93	18
Midliner S 150.08/A	11/92→01/94	24
Midliner S 150.08/A,S 150.08/B	11/92→01/94	24
Midliner S 150.08/A,S 150.08/B	01/94→05/96	20
Midliner S 150.08/B	11/92→01/94	24
Midliner S 150.08/B	01/94→05/96	20
Midliner S 150.08TI	05/83→07/86	19
Midliner S 150.08TI	05/86→09/90	16
Midliner S 150.08TI/R	05/86→09/90	16
Midliner S 150.09/B	11/92→01/94	24
Midliner S 150.09/B	01/94→05/96	20
Midliner S 150.09/B	05/96→01/00	30
Midliner S 150.09/B,S 135.09/B	05/96→01/00	12
Midliner S 150.09TI	05/83→07/86	19
Midliner S 150.09TI	05/86→09/90	16
Midliner S 150.11TI	05/86→09/90	16
Midliner S 150.13TI	04/86→09/90	16
Midliner S 150.14TI BOM	05/86→09/90	16
Midliner S 160.08/A,S 160.08/B	01/90→09/93	16
Midliner S 160.08/B	01/90→09/93	16
Midliner S 160.09/B	01/90→09/93	16
Midliner S 160.09/B SP	01/90→09/93	16
Midliner S 170.11TI	10/87→05/89	21
Midliner S 170.11TI/R	10/87→05/89	21
Midliner S 170.13TI	10/83→03/93	21
Midliner S 170.13TI,S 170 SP	10/83→03/93	21
Midliner S 170.13TI,S 170.13TI/R	10/83→05/89	21
Midliner S 170.13TI/T	10/84→05/89	21
Midliner S 170.14TI	10/83→05/89	21
Midliner S 170.14TI/R	10/87→05/89	21
Midliner S 170.15TI	10/82→09/93	21
Midliner S 180.08/A	11/92→10/96	24
Midliner S 180.08/A	05/96→01/00	30
Midliner S 180.08/A,S 180.08/B	11/92→10/96	24
Midliner S 180.09/B	11/92→10/96	24
Midliner S 180.09/B	05/96→01/00	30
Midliner S 180.09/B SP	11/92→10/96	24
Midliner S 210.08/A	04/95→01/00	24
Midliner S 210.08/A	04/95→01/00	30
Midliner S 210.09/B	04/95→01/00	24



21

9



21

9

Midliner S 210.09/B	04/95→01/00	30	Premium Distribution 320.24D	08/00→	62
Midliner S 220.11TI	09/87→09/90	30	Premium Distribution 320.26D	08/00→	62
Midliner S 220.11TI	09/87→09/90	32	Premium Distribution 340.18D	04/96→	53
Midliner S 220.13TI	09/87→09/90	30	Premium Distribution 340.18D/T	04/96→	53
Midliner S 220.13TI	09/87→09/90	32	Premium Distribution 340.19D	04/96→	53
Midliner S 220.13TI/T	09/87→09/90	30	Premium Distribution 340.19D/T	04/96→	53
Midliner S 220.13TI/T	09/87→09/90	32	Premium Distribution 340.26D	04/96→	53
Midliner S 220.14TI	09/87→09/90	30	Premium Distribution 370.18	08/00→	62
Midliner S 220.14TI	09/87→09/90	32	Premium Distribution 370.18D	08/00→	62
Midliner S 220.14TI/T	09/87→09/90	30	Premium Distribution 370.24D	08/00→	62
Midliner S 220.14TI/T	09/87→09/90	32	Premium Distribution 370.26D	08/00→	62
Midlum 135.08/B,150.08/B	01/00→	13	Premium Distribution 400.18D	01/00→	63
Midlum 135.09/B,150.09/B	01/00→	13	Premium Distribution 400.18D/T	01/00→	63
Midlum 135.10/B,150.10/B	01/00→	13	Premium Distribution 420.18	08/00→	62
Midlum 150.08/B	10/01→	14	Premium Distribution 420.18D	08/00→	62
Midlum 150.10/B	10/01→	27	Premium Route 300.16	09/96→	50
Midlum 150.12/B	01/00→	13	Premium Route 300.18	09/96→	50
Midlum 150.12/B	01/00→	14	Premium Route 300.18T	09/96→	50
Midlum 180	10/01→	14	Premium Route 300.19	09/96→	50
Midlum 180.08/B	01/00→	26	Premium Route 300.19T	09/96→	50
Midlum 180.08/B	10/01→	14	Premium Route 320.18	08/00→	62
Midlum 180.09/B	01/00→	26	Premium Route 340.18	04/96→	53
Midlum 180.10/B	01/00→	26	Premium Route 340.18T	04/96→	53
Midlum 180.10/B	10/01→	14	Premium Route 340.19	04/96→	53
Midlum 180.12	10/01→	14	Premium Route 340.19T	04/96→	53
Midlum 180.12/B	01/00→	26	Premium Route 340.24	04/96→	53
Midlum 210.08/B	01/00→	26	Premium Route 340.26	04/96→	53
Midlum 210.08/B	01/00→	27	Premium Route 370.18	08/00→	62
Midlum 210.09/B	01/00→	26	Premium Route 370.24	08/00→	62
Midlum 210.10/B	01/00→	26	Premium Route 370.26	08/00→	62
Midlum 210.10/B	01/00→	27	Premium Route 385.18,400.18	04/96→	63
Midlum 210.12/C	01/00→	26	Premium Route 385.18T,400.18T	04/96→	63
Midlum 210.12/C	01/00→	27	Premium Route 385.19,400.19	04/96→	63
Midlum 210.13/C	01/00→	26	Premium Route 385.19T,400.19T	04/96→	63
Midlum 210.13/C	01/00→	27	Premium Route 385.24,400.24	04/96→	63
Midlum 210.14/C	01/00→	26	Premium Route 385.24T,400.24T	09/96→	63
Midlum 210.14/C	01/00→	27	Premium Route 385.26	04/96→	63
Midlum 210.15/C	01/00→	26	Premium Route 385.26,400.26	04/96→	63
Midlum 210.16/C	01/00→	26	Premium Route 420.18	08/00→	62
Midlum 210.16/C	01/00→	27	Premium Route 420.18T	08/00→	62
Midlum 220.12	10/01→	27	Premium Route 420.24	08/00→	62
Midlum 220.14	10/01→	27	Premium Route 420.25	08/00→	62
Midlum 220.15	10/01→	27	Premium Route 420.26	08/00→	62
Midlum 220.18/D	10/01→	27	R R 310.16	10/80→03/89	64
Midlum 250.12/C	01/00→	28	R R 310.16/T	10/80→03/89	64
Midlum 250.13/C	01/00→	28	R R 310.17	10/80→03/89	64
Midlum 250.14/C	01/00→	28	R R 310.17/T	10/80→03/89	64
Midlum 250.15/C	01/00→	28	R R 310.19	10/80→03/89	64
Midlum 250.16/C	01/00→	28	R R 310.19/T	10/80→03/89	64
Midlum 250.16/CT	01/00→	28	R R 310.22	10/80→03/89	64
Midlum 270.12/C	10/01→	27	R R 310.22/T	10/80→03/89	64
Midlum 270.13/C	10/01→	27	R R 330.17	05/88→05/91	48
Midlum 270.14/C	10/01→	27	R R 330.17/T	05/88→05/91	48
Midlum 270.16/C	10/01→	27	R R 330.19	05/88→05/91	48
Premium Distribution 210.16	04/96→	26	R R 330.19/T	05/88→05/91	48
Premium Distribution 210.18D, 220.18	04/96→	26	R R 330.24	05/88→05/91	48
Premium Distribution 210.18D, 220.18	04/96→	27	R R 340.17	03/86→01/90	71
Premium Distribution 250.16	04/96→	28	R R 340.17/T	03/86→01/90	71
Premium Distribution 250.18D	04/96→	28	R R 340.19	03/86→01/90	71
Premium Distribution 250.19	04/96→	28	R R 340.19/T	03/86→01/90	71
Premium Distribution 260.16	04/96→	45	R R 340.24	03/86→01/90	71
Premium Distribution 260.18	04/96→	45	R R 340ti.16/T	01/90→05/91	48
Premium Distribution 260.19	04/96→	45	R R 340ti.17	01/90→05/91	48
Premium Distribution 270.18	08/00→	27	R R 340ti.18	01/90→05/91	48
Premium Distribution 300.16D	04/96→	50	R R 340ti.18/T	01/90→05/91	48
Premium Distribution 300.16T	04/96→	50	R R 340ti.19	01/90→05/91	48
Premium Distribution 300.18D	04/96→	50	R R 340ti.19/T	01/90→05/91	48
Premium Distribution 300.18D/T	04/96→	50	R R 340ti.24	01/90→05/91	48
Premium Distribution 300.19	04/96→	50	R R 340ti.26	01/90→05/91	48
Premium Distribution 300.19D/T	04/96→	50	R R 350.17	01/90→05/91	71
Premium Distribution 300.26D	04/96→	50	R R 350.17/T	01/90→05/91	71
Premium Distribution 320.18	08/00→	62	R R 350.18	01/90→05/91	71
Premium Distribution 320.18 D	08/00→	62	R R 350.18/T	01/90→05/91	71



Family
21

9



Family
21

9

R R 350.19	01/90→05/91	71
R R 350.19/T	01/90→05/91	71
R R 350.19/TB	01/90→05/91	71
R R 350.24	01/90→05/91	71
R R 350.26	01/90→05/91	71
R R 365.17	10/87→05/90	65
R R 365.17/T	10/87→05/90	65
R R 365.19	10/87→05/90	65
R R 365.19/T	10/87→05/90	65
R R 365.24	10/87→05/90	65
R R 380.17	01/90→05/91	65
R R 380.18	01/90→05/91	65
R R 380.18/T	01/90→05/91	65
R R 380.19	01/90→05/91	65
R R 380.19/T	01/90→05/91	65
R R 380.19/TB	01/90→05/91	65
R R 380.22/T	01/90→05/91	65
R R 380.24	01/90→05/91	65
R R 380.25	01/90→05/91	65
R R 380.25/T	01/90→05/91	65
R R 380.26	01/90→05/91	65
R R 380.26/T	01/90→05/91	65
Tracer	01/91→	44

RENAULT TRUCKS / RVI









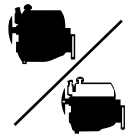



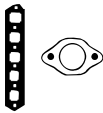

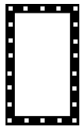

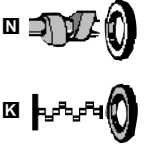
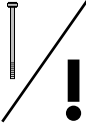





























































































































cc



kW/PS



1	8140.27 8140.47.2530 IDR	2499 2499	4 4	93.00 93.00	Sofim/Turbo Sofim/Turbo	78/106 85/116	AB5100 (Fibre), 1.20mm [12] AY580 (Fibre), 1.30mm [12] AY590 (Fibre), 1.40mm [12] AB5110 (Fibre), 1.50mm [12]	DS381 ▲ [19]	
2	8140.47.2585/8140.47.2590	2499	4	93.00	Euro 1/Turbo Intercooled	85/116	AB5100 (Fibre), 1.20mm [12] AY580 (Fibre), 1.30mm [12] AY590 (Fibre), 1.40mm [12] AB5110 (Fibre), 1.50mm [12]	DS381 ▲ [19]	FB5101 ▲ [7][37]
3	8140-47	2499	4	93.00	Turbo Intercooled	85/116	AB5100 (Fibre), 1.20mm [12] AY580 (Fibre), 1.30mm [12] AY590 (Fibre), 1.40mm [12] AB5110 (Fibre), 1.50mm [12]	DS381 ▲ [19]	FB5101 ▲ [7][37]
4	8140.43N.3585	2798	4	94.40	Euro 3/Turbo Intercooled	107/146	BX390 (Fibre), 1.20mm [9] BX400 (Fibre), 1.30mm [9] BX410 (Fibre), 1.40mm [9] BX420 (Fibre), 1.50mm [9]		
5	8140.63.2585	2800	4	94.40	Euro 2/Turbo Intercooled	63/86	AY680 (Fibre), 1.60mm AY690 (Fibre), 1.70mm AY700 (Fibre), 1.80mm	CY680 ▲	
6	8140.23.2585	2800	4	94.40	Sofim/Euro 2/Turbo Intercooled	78/106	BX390 (Fibre), 1.20mm [9] BX400 (Fibre), 1.30mm [9] BX410 (Fibre), 1.40mm [9] BX420 (Fibre), 1.50mm [9]	DX391 ▲	GX410 ▲
7	8140.43.C.2586 8140.43.C.3586/ 8140.43.C.3588	2800 2800	4 4	94.40 94.40	Turbo Intercooled Euro 3/Turbo Intercooled	78/106 78/106	BX390 (Fibre), 1.20mm [9] BX400 (Fibre), 1.30mm [9] BX410 (Fibre), 1.40mm [9] BX420 (Fibre), 1.50mm [9]		
8	8140.43.2585	2800	4	94.40	Sofim/Euro 2/Turbo Intercooled	90/122	BX390 (Fibre), 1.20mm [9] BX400 (Fibre), 1.30mm [9] BX410 (Fibre), 1.40mm [9] BX420 (Fibre), 1.50mm [9]	DX391 ▲	GX410 ▲
9	8140.43.S.2585 8140.43.S.3585 8140-43 k	2800 2800 2800	4 4 4	94.40 94.40 94.40	Euro 2/Turbo Intercooled Euro 3/Turbo Intercooled Euro 3/Turbo Intercooled	92/125 92/125 103/140	BX390 (Fibre), 1.20mm [9] BX400 (Fibre), 1.30mm [9] BX410 (Fibre), 1.40mm [9] BX420 (Fibre), 1.50mm [9]	DX400 ▲	GX410 ▲
10	712-01-03 712-01-04 712	3320 3320 3320	4 4 4	98.00 98.00 98.00		53/72 54/73 56/76	BF980 (Fibre), 1.20mm	DF980 ■	GF980 [7] GF981 →Eng.7104 GF982 Eng.7105→
11	720-12 720	3590 3590	4 4	102.00 102.00		67-72/ 90-98 67-72/ 91-98	BF980 (Fibre), 1.20mm →Eng.201 BF990 (Fibre), 1.50mm Eng.201→	DF980 ■ →Eng.201 DF990 ■ Eng.201→	GF982 →Eng.200 GF990 Eng.201→
12	MIDR 04.02.26 A/41 MIDR 04.02.26 B/41	4100 4100	4 4	102.00 102.00	Euro 2/Turbo Intercooled Euro 2/Turbo Intercooled	100/136 110/150			
13	MIDR 04.02.26 A/4 MIDR 04.02.26 B/4	4120 4120	4 4	102.00 102.00	Euro 2/Turbo Intercooled Euro 2/Turbo Intercooled	100/136 110/150			
14	dCi 4B dCi 4C	4120 4120	4 4	102.00 102.00	Euro 3 Euro 3/Turbo Intercooled	112/152 128/174			

     						
JC054  (x4) JC055  (x4)	JN594 [9]	JJ519		 NP067  50x70x10mm, FPM		 AB5100, AB5110  AY580, AY590  AY680, AY690, AY700  BF980  BF990  BX390, BX400, BX410, BX420
JC054  (x4) JC055  (x4)  JF123 (x4)	JN594 [9] JN956	JJ533	HR602 	 NP067 50x70x10mm, FPM  NP068 55x70x8mm, FPM  NA784  70x90x10mm, ACM	HJ271 [13]  JR580 [11] →Eng.2921820 KK5599 [57] Eng.2921820→	 JJ068  JJ519  JJ533  JJ613
JC054  (x4) JC055  (x4)  JF123 (x4)	JN594 [9] JN596	JJ519		 NP068 55x70x8mm, FPM  NP067  50x70x10mm, FPM	JR580 [11] →Eng.2921820 KK5599 [57] Eng.2921820→	 HBS011 [8]  M12x1.25x160mm (x10) M12x1.25x119mm (x12)
JC054  (x4) JC055  (x4)	JP069	JJ613	HR602 	 NF885  [24] 70x159x16mm, FPM  NF883  [24] 114x171x13mm, FPM	JR580 [11] →Eng.2921820	 JB897  JC054  JC055  JD318
JC054  (x4) JC055  (x4)	JN956	JJ519	HR602 	 NP067 50x70x10mm, FPM  NP068 55x70x8mm, FPM  NF885  [24] 70x159x16mm, FPM  NF883  [24] 114x171x13mm, FPM	HBS011 [8]  M12x1.25x160mm (x10) M12x1.25x119mm (x12) KD929 [51][54] KD931 [51][54] JR580 [11] LC280 [11] LC281 [11] LC282 [11] KK5599 [57] Eng.2921820→ LA190 [58]	 JC054  JC055  JD318
JC054  (x4) JC055  (x4)	JN956	JJ613	HR602 	 NF885  [24] 70x159x16mm, FPM  NF883  [24] 114x171x13mm, FPM	HBS011 [8]  M12x1.25x160mm (x10) M12x1.25x119mm (x12)	 JF123  JN594  JN596  JN956  JP069
JC054  (x4) JC055  (x4)	JN956	JJ519	HR602 	 NF885  [24] 70x159x16mm, FPM  NF883  [24] 114x171x13mm, FPM	HBS011 [8]  M12x1.25x160mm (x10) M12x1.25x119mm (x12)	 JF123  JN594  JN596  JN956  JP069
JC054  (x4) JC055  (x4)	JN956	JJ613	HR602 	 NF885  [24] 70x159x16mm, FPM  NF883  [24] 114x171x13mm, FPM	HBS011 [8]  M12x1.25x160mm (x10) M12x1.25x119mm (x12)	 JF123  JN594  JN596  JN956  JP069
JB897  (x4)		JJ068		 NA5039 95x120x13mm, FPM  NF604  50x70x10mm, MVQ  NF603  95x120x13mm, MVQ →Eng.7104  NF715  110x130x13mm Eng.7105→	PA714 [14] 	 JN594  JN596  JN956  JP069
JB897  (x4)		JJ068 →Eng.200		 NF604  50x70x10mm, MVQ  NF636  55x70x10mm  NF715  110x130x13mm	PA706 (x8)[14] 	 JN594  JN596  JN956  JP069
JD318  (x4)		HR397 [20]		 NA5181  110x130x13mm, PTFE  NF837  110x130x13mm, FPM		
JD318  (x4)		HR397 [20]		 NF837  110x130x13mm, FPM  NA5181  110x130x13mm, PTFE		
JD318  (x4)			HR602 	 NA5181  110x130x13mm, PTFE  NF837  110x130x13mm, FPM		

RENAULT TRUCKS / RVI









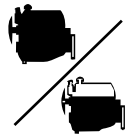



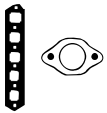

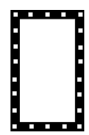
cc

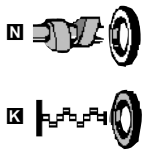
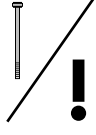
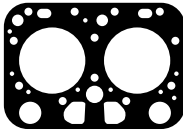
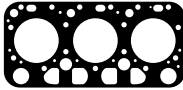

kW/PS

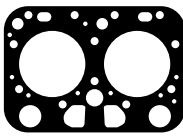

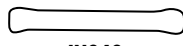
15	797-21 797	5453 5453	6 6	102.00 102.00		76/103 96-97/ 130-132	BF970 (Fibre), 1.30mm	DF970 ■	GF970 [7]
16	MIDS 06.02.12 B	5453	6	102.00	Turbo	113-117/ 154-159	BL600 (Fibre), 1.50mm	DL602 ▲○	EL600 →05/90 EL601 06/90→ GL600 ○
17	797-20 797-26	5490 5490	6 6	102.00 102.00	Turbo Turbo	96-98/ 130-133 98/133	BF970 (Fibre), 1.30mm	DF970 ■	GF970 [7]
18	MIDS 06.02.12 C MIDS 06.02.12	5490 5490	6 6	102.00 102.00	Turbo Turbo	97-103/ 132-140 107/145	BL600 (Fibre), 1.50mm	DL602 ▲○	EL601
19	798 798-13 798-10/798-20	5490 5490 5490	6 6 6	102.00 102.00 102.00	Turbo Turbo Turbo	110/150 111-112/ 151-152 113/154	BL600 (Fibre), 1.50mm		EL600
20	MIDS 06.02.12 D/3	5490	6	102.00	Turbo	110/150	BW920 (Fibre)	DL602 ▲○	EL601
21	MIDR 06.02.12 D	5490	6	102.00	Turbo Intercooled	127-134/ 172-182	BL600 (Fibre), 1.50mm	DL602 ▲○	EL601 GL600 ○
22	797 NFA	5491	6	102.00		89/121	BL600 (Fibre), 1.50mm		
23	MIDR 06.02.12	5491	6	102.00	Turbo Intercooled	128-134/ 173-182	BL600 (Fibre), 1.50mm	DL602 ▲○	EL600 →02/90 EL601 03/90→
24	MIDR 06.02.26 U MIDR 06.02.26 V MIDR 06.02.26 W	6174 6174 6174	6 6 6	102.00 102.00 102.00	Euro 1/Turbo Intercooled Euro 1/Turbo Intercooled Euro 1/Turbo Intercooled	110/150 129-132/ 175-180 151/205	BW920 (Fibre)	DL602 ▲○	EL601
25	MIDR 06.02.26 S	6174	6	102.00	Turbo Intercooled	166/226	BW920 (Fibre)	DL602 ▲○	EL601
26	MIDR 06.02.26 V/4 MIDR 06.02.26 W/4	6177 6177	6 6	102.00 102.00	Euro 2/Turbo Intercooled Euro 2/Turbo Intercooled	132/180 154/210	BW920 (Fibre) BW920 (Fibre)	DL602 ▲○ DL602 ▲○	EL601 EL601
27	dci 6W dci 6A	6177 6177	6 6	102.00 102.00	Euro 3/Turbo Intercooled Euro 3/Turbo Intercooled	158/215 195/265	BW920 (Fibre)		EL601
28	MIDR 06.02.26 Y/41	6177	6	102.00	Euro 2/Turbo Intercooled	184/250	BW920 (Fibre)		EL601
29	MIDR 06.02.26 H	6178	6	102.00	Turbo Intercooled	133-144/ 181-196	BW920 (Fibre)	DL602 ▲○	EL601
30	MIDR 06.02.26 U/4 MIDR 06.02.26 V/41 MIDR 06.02.26 W/41 MIDR 06.02.26 D MIDR 06.02.26 X	6180 6180 6180 6180 6180	6 6 6 6 6	102.00 102.00 102.00 102.00 102.00	Euro 2/Turbo Intercooled Euro 2/Turbo Intercooled Euro 2/Turbo Intercooled Turbo Intercooled Euro 1/Turbo Intercooled	110/150 132/180 154/210 166/226 166/226	BW920 (Fibre)	DL602 ▲○	EL601
31	MIDR 06.02.26 Q	6180	6	102.00	Turbo	137-140/ 186-190	BW920 (Fibre)	DL602 ▲○	EL601
32	MIDR 06.02.26	6180	6	102.00	Turbo Intercooled	159/216	BW920 (Fibre)	DL602 ▲○	EL601
33	M 520	7917	5	120.00		108-110/ 147-150	BH840 (Steel), 1.20mm [38][39] BN290 (Steel), 1.20mm [39][40] BF780 (Fibre), 1.35mm [40] BF800 (Fibre), 1.35mm [38]	DF806 ■○	EZ202

     							
		JJ069		<input checked="" type="checkbox"/> NF715 <input checked="" type="checkbox"/> 110x130x13mm	PA706 [14] <input checked="" type="checkbox"/>		BF780
JD318 <input checked="" type="checkbox"/> (x6)	JN269 →05/90 JN949 06/90 →	JJ069		<input checked="" type="checkbox"/> NA5181 <input checked="" type="checkbox"/> 110x130x13mm, PTFE <input checked="" type="checkbox"/> NF837 <input checked="" type="checkbox"/> 110x130x13mm, FPM <input checked="" type="checkbox"/> NF754 <input checked="" type="checkbox"/> 110x130x12mm, FPM	PA706 [14] <input checked="" type="checkbox"/>		BF800
		JJ069		<input checked="" type="checkbox"/> NF715 <input checked="" type="checkbox"/> 110x130x13mm	PA706 [14] <input checked="" type="checkbox"/>		BF970
JD318 <input checked="" type="checkbox"/> (x6)	JN269 →02/90 JN949 03/90 →	JJ069		<input checked="" type="checkbox"/> NA5181 <input checked="" type="checkbox"/> 110x130x13mm, PTFE <input checked="" type="checkbox"/> NF837 <input checked="" type="checkbox"/> 110x130x13mm, FPM			BH840
JD318 <input checked="" type="checkbox"/> (x6)	JN269	JJ069		<input checked="" type="checkbox"/> NF715 <input checked="" type="checkbox"/> 110x130x13mm	PA706 (x12) [14] <input checked="" type="checkbox"/>		BL600
JD318 <input checked="" type="checkbox"/> (x6)	JN949	JJ069		<input checked="" type="checkbox"/> NA5181 <input checked="" type="checkbox"/> 110x130x13mm, PTFE <input checked="" type="checkbox"/> NF837 <input checked="" type="checkbox"/> 110x130x13mm, FPM			BN290
JD318 <input checked="" type="checkbox"/> (x6)	JN269 →02/90 JN949 03/90 →	JJ069		<input checked="" type="checkbox"/> NA5181 <input checked="" type="checkbox"/> 110x130x13mm, PTFE <input checked="" type="checkbox"/> NF837 <input checked="" type="checkbox"/> 110x130x13mm, FPM <input checked="" type="checkbox"/> NF754 <input checked="" type="checkbox"/> 110x130x12mm, FPM			BW920
JD318 <input checked="" type="checkbox"/> (x6)	JN269 →02/90 JN949 03/90 →	JJ069		<input checked="" type="checkbox"/> NF715 <input checked="" type="checkbox"/> 110x130x13mm	PA706 [14] <input checked="" type="checkbox"/>		JD318
JD318 <input checked="" type="checkbox"/> (x6)	JN269 →02/90 JN949 03/90 →	JJ069		<input checked="" type="checkbox"/> NA5181 <input checked="" type="checkbox"/> 110x130x13mm, PTFE <input checked="" type="checkbox"/> NF837 <input checked="" type="checkbox"/> 110x130x13mm, FPM			JN949
JD318 <input checked="" type="checkbox"/> (x6)	JN269 →02/90 JN949 03/90 →	JJ069		<input checked="" type="checkbox"/> NA5181 <input checked="" type="checkbox"/> 110x130x13mm, PTFE <input checked="" type="checkbox"/> NF837 <input checked="" type="checkbox"/> 110x130x13mm, FPM			JJ069
JD318 <input checked="" type="checkbox"/> (x6)		JJ069		<input checked="" type="checkbox"/> NA5181 <input checked="" type="checkbox"/> 110x130x13mm, PTFE			
JD318 <input checked="" type="checkbox"/> (x6)		JJ069		<input checked="" type="checkbox"/> NA5181 <input checked="" type="checkbox"/> 110x130x13mm, PTFE <input checked="" type="checkbox"/> NF837 <input checked="" type="checkbox"/> 110x130x13mm, FPM			
JD318 <input checked="" type="checkbox"/> (x6)		JJ069		<input checked="" type="checkbox"/> NA5181 <input checked="" type="checkbox"/> 110x130x13mm, PTFE <input checked="" type="checkbox"/> NF837 <input checked="" type="checkbox"/> 110x130x13mm, FPM			
JD318 <input checked="" type="checkbox"/> (x6)	JN269 →02/90 JN949 02/90 →	JJ069		<input checked="" type="checkbox"/> NA5181 <input checked="" type="checkbox"/> 110x130x13mm, PTFE <input checked="" type="checkbox"/> NF837 <input checked="" type="checkbox"/> 110x130x13mm, FPM			
JD318 <input checked="" type="checkbox"/> (x6)	JN269 →02/90 JN949 03/90 →	JJ069		<input checked="" type="checkbox"/> NA5181 <input checked="" type="checkbox"/> 110x130x13mm, PTFE <input checked="" type="checkbox"/> NF837 <input checked="" type="checkbox"/> 110x130x13mm, FPM			
JD318 <input checked="" type="checkbox"/> (x6)	JN269 →02/90 JN949 03/90 →	JJ069		<input checked="" type="checkbox"/> NF837 <input checked="" type="checkbox"/> 110x130x13mm, FPM <input checked="" type="checkbox"/> NA5181 <input checked="" type="checkbox"/> 110x130x13mm, PTFE			
				<input checked="" type="checkbox"/> NA5181 <input checked="" type="checkbox"/> 110x130x13mm, PTFE <input checked="" type="checkbox"/> NF837 <input checked="" type="checkbox"/> 110x130x13mm, FPM			
					PA705 (x5) [14] <input checked="" type="checkbox"/>		

RENAULT TRUCKS / RVI



cc



kW/PS

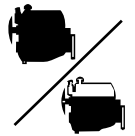

34	MID 06.20.30 C/ MID 06.20.30 D MID 06.20.30 H	8820	6	120.00		135-141/ 184-192 141/192	BW390 (SE) (x6)	DG080 ■ (x6) [41] DG082 ■ [42]	EZ193 →05/88 EZ197 06/88→
		8820	6	120.00					
35	MID 06.20.30 G	8820	6	120.00		141/192	BW390 (SE) (x6)	DG080 ■ (x6) [41] DG082 ■ [42]	EZ193 →05/88 EZ197 06/88→
36	MIP 06.20.30	8820	6	120.00		141-158/ 192-215	BW390 (SE) (x6)	DG080 ■ (x6) [41] DG082 ■ [42]	EZ195
	MIPS 06.20.30	8820	6	120.00	Turbo	166/226			
37	MIDR 06.20.30 B/ MIDR 06.20.30 C	8820	6	120.00	Turbo Intercooled	146-158/ 199-215	BW390 (SE) (x6)	DG080 ■ (x6) [41] DG082 ■ [42]	
	MIDS 06.20.30 K	8820	6	120.00	Turbo	158/215			
	MIDS 06.20.30 B/ MIDS 06.20.30 E	8820	6	120.00	Turbo	159/216			
	MIDS 06.20.30 D	8820	6	120.00	Turbo	169/230			
38	MIDS 06.20.30 N	8820	6	120.00	Turbo	153/208	BW390 (SE) (x6)	DG080 ■ (x6) [41] DG082 ■ [42]	EZ193 →10/85 EZ196 11/85→05/88 EZ197 06/88→
39	MIDS 06.20.30 N1	8820	6	120.00	Turbo	162/220	BW390 (SE)	DG080 ■ (x6) [41] DG082 ■ [42]	EZ193 →10/85 EZ196 11/85→05/88 EZ197 06/88→
	MIDR 06.20.30 A	8820	6	120.00	Turbo Intercooled	194/265			
40	MIDS 06.20.30	8821	6	120.00	Turbo	169/230	BW390 (SE)	DG080 ■ (x6) [41] DG082 ■ [42]	EZ193 →10/85 EZ196 11/85→05/88 EZ197 06/88→
	MIDS 06.20.30 P	8821	6	120.00	Turbo	169-177/ 230-240			
41	M 620 Z 3	9500	6	120.00		132/180	BH840 (Steel), 1.20mm (x2) BF800 (Fibre), 1.35mm (x2)	DF805 ■○	EZ192
42	MIDR 06.20.45	9771	6	120.00	Turbo Intercooled	214-222/ 291-302	BW390 (SE) (x6)	DG083 ■ DW390 ■ (x6)	EZ197
43	MIDR 06.20.45 J3	9800	6	120.00	Turbo Intercooled	168/228	BW390 (SE) (x6)	DG083 ■ DW390 ■ (x6)	EZ197
44	MIHR 06.20.45 A41	9839	6	120.00	Euro 2/Turbo Intercooled	185/252	BW390 (SE) (x6)		
	MIDR 06.20.45 R41	9839	6	120.00	Euro 2/Turbo Intercooled	222/302			
	MIDR 06.20.45 M41	9839	6	120.00	Euro 2/Turbo Intercooled	250/340			
45	MIDR 06.20.45 C/4	9839	6	120.00	Euro 2/Turbo Intercooled	188/256	BW390 (SE) (x6)		
46	MIDR 06.20.45 A	9839	6	120.00	Turbo Intercooled	192/260	BW390 (SE) (x6)	DG083 ■ DW390 ■ (x6)	EZ193 →10/85 EZ196 11/85→05/88 EZ197 06/88→

						 BF800 BH840 BW390 JB925 JD250 JD319 JN346 JJ456 JJ546
JD319 (x2) JB925 (x6) JD250 (x6) 09/93→	JN346 (x6)	JJ546				
JD319 (x2) JB925 (x6) JD250 (x6) 09/83→	JN346 (x6)	JJ546		<input checked="" type="checkbox"/> NF832 90x110x11mm, PTFE <input checked="" type="checkbox"/> NF840 150x172x13mm, FPM	PA708 (x12) [14] [43] <input checked="" type="checkbox"/> PA709 (x18) [14] →05/88 LB802 [14] [44] 06/88→	
JB925 (x6)	JN346 (x6)	JJ546		<input checked="" type="checkbox"/> NF832 90x110x11mm, PTFE <input checked="" type="checkbox"/> NF840 150x172x13mm, FPM	PA708 (x12) [14] [43] <input checked="" type="checkbox"/> PA709 (x18) [14] →05/88 LB802 [14] [44] 06/88→	
JB925 (x6)	JN346 (x6)	JJ546		<input checked="" type="checkbox"/> NF832 90x110x11mm, PTFE <input checked="" type="checkbox"/> NF840 150x172x13mm, FPM	PA709 [14] →05/88 PA708 [14] [43] <input checked="" type="checkbox"/> LB802 [14] [44] 06/88→	
JD319 (x2) JB925 (x6) JD250 (x6) 09/83→	JN346 (x6)	JJ546				
JD319 (x2) JB925 (x6) JD250 (x6)	JN346 (x6)	JJ546		<input checked="" type="checkbox"/> NF832 90x110x11mm, PTFE <input checked="" type="checkbox"/> NF840 150x172x13mm, FPM	LB802 [14] [44] PA708 [14] [43] PA709 [14]	
JD319 (x2) JB925 (x6) JD250 (x6)	JN346 (x6)	JJ546		<input checked="" type="checkbox"/> NF832 90x110x11mm, PTFE <input checked="" type="checkbox"/> NF840 150x172x13mm, FPM	PA708 [14] [43] PA709 [14] →05/88 LB802 [14] [44] 06/88→	
		HC366		<input checked="" type="checkbox"/> NF013	PA705 (x6) [14]	
JD319 (x2) JB925 (x6) JD250 (x6) 07/90→08/93	JN346 (x6)	JJ546		<input checked="" type="checkbox"/> NF832 90x110x11mm, PTFE <input checked="" type="checkbox"/> NF840 150x172x13mm, FPM	LB802 [14] [44] PA708 [14] [43]	
JD319 (x2) JB925 (x6) JD250 (x6) 07/90→08/93	JN346 (x6)	JJ546		<input checked="" type="checkbox"/> NF832 90x110x11mm, PTFE <input checked="" type="checkbox"/> NF840 150x172x13mm, FPM	LB802 [14] [44] PA708 [14] [43]	
JD319 (x2)	JN346 (x6)	JJ456		<input checked="" type="checkbox"/> NF832 90x110x11mm, PTFE <input checked="" type="checkbox"/> NF840 150x172x13mm, FPM		
JD319 (x2) JB925 (x6)	JN346 (x6)	JJ546		<input checked="" type="checkbox"/> NF840 150x172x13mm, FPM →11/85 <input checked="" type="checkbox"/> NF839 85x110x13mm, FPM 11/85→06/88 <input checked="" type="checkbox"/> NF832 90x110x11mm, PTFE 06/88→	PA708 (x12) [14] [43] <input checked="" type="checkbox"/> PA709 (x18) [14] →05/88 LB802 (x18) [14] [44] <input checked="" type="checkbox"/> 06/88→	

RENAULT TRUCKS / RVI









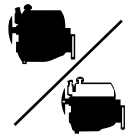



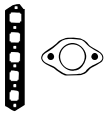

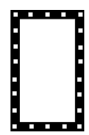

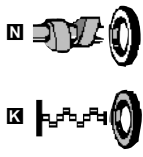
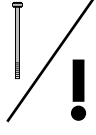
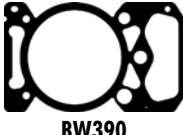









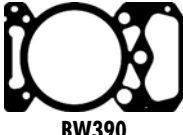

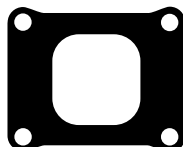



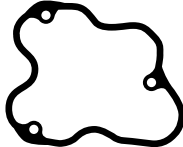

































































cc



kW/PS



47	MIDS 06.20.45 B	9839	6	120.00	Turbo	192-202/ 260-275	BW390 (SE) (x6)	DG083 ■ DW390 ■ (x6)	EZ193 →10/85 EZ196 11/85→05/88 EZ197 06/88→
48	MIDS 06.20.45 MIDR 06.20.45 B3 MIDR 06.20.45 E	9839 9839 9839	6 6 6	120.00 120.00 120.00	Turbo Turbo Intercooled Turbo Intercooled	192-202/ 261-275 195/265 240-249/ 326-339	BW390 (SE) (x6)	DG083 ■ DW390 ■ (x6)	EZ197
49	MIDR 06.20.45 D	9839	6	120.00	Turbo Intercooled	210-222/ 286-302	BW390 (SE) (x6)	DG083 ■ DW390 ■ (x6)	EZ193 →10/85 EZ196 11/85→05/88 EZ197 06/88→
50	MIDR 06.20.45 D/41	9839	6	120.00	Euro 2/Turbo Intercooled	219/298	BW390 (SE) (x6)	DG083 ■ DW390 ■ (x6)	EZ197
51	MIDR 06.20.45 D3	9839	6	120.00	Euro 1/Turbo Intercooled	222/302	BW920 (Fibre)		EL601
52	MIDR 06.20.45 H MIDR 06.20.45 E2	9839 9839	6 6	120.00 120.00	Turbo Intercooled Turbo Intercooled	227-240/ 310-326 249/339	BW390 (SE) (x6)	DG083 ■ DW390 ■ (x6)	EZ197
53	MIDR 06.20.45 E/41	9839	6	120.00	Euro 2/Turbo Intercooled	249/338	BW390 (SE) (x6)	DG083 ■ DW390 ■ (x6)	EZ197
54	MIDR 06.20.45 E3	9839	6	120.00	Euro 1/Turbo Intercooled	249/338	BW390 (SE) (x6)	DG083 ■ DW390 ■ (x6)	EZ197
55	MIDS 06.20.45 D	9840	6	120.00	Turbo	129/175	BW390 (SE) (x6)	DG083 ■ DW390 ■ (x6)	EZ193 →10/85 EZ196 11/85→05/88 EZ197 06/88→
56	MIPS 06.20.45 A MIDR 06.20.45 F3 MIDS 06.20.45 F/ MIPS 06.20.45 C MID 06.20.45/ MIPR 06.20.45 C3 MIPS 06.20.45 B MIDR 06.20.45 K MIDR 06.20.45 L MIPR 06.20.45 B3 MIDR 06.20.45 I41 MIDR 06.20.45 I3 MIDR 06.20.45 A2 MIDR 06.20.45 C MIDR 06.20.45 M MIDR 06.20.45 M3	9840 9840 9840 9840 9840 9840 9840 9840 9840 9840 9840 9840 9840 9840 9840 9840 9840 9840 9840	6 6 6 6 6 6 6 6 6 6 6 6 6 6 6 6 6 6	120.00 120.00 120.00 120.00 120.00 120.00 120.00 120.00 120.00 120.00 120.00 120.00 120.00 120.00 120.00 120.00 120.00	Turbo Intercooled Turbo Intercooled Turbo Turbo Intercooled Turbo Intercooled Turbo Intercooled Turbo Intercooled Euro 2/Turbo Intercooled Turbo Intercooled Turbo Intercooled Turbo Intercooled Turbo Intercooled Turbo Intercooled Turbo Intercooled Turbo Intercooled Turbo Intercooled	129/175 144/196 144/196 152/207 176/240 177/240 177/240 186/253 188/256 191/260 202/275 206-210/ 280-285 236/320 250/340	BW390 (SE) (x6)	DG083 ■ DW390 ■ (x6)	
57	MIPS 06.20.45	9840	6	120.00	Turbo Intercooled	137-186/ 186-253	BW390 (SE) (x6)	DG083 ■ DW390 ■ (x6)	EZ196
58	MIDS 06.20.45 J	9840	6	120.00	Turbo	161/220	BW390 (SE) (x6)	DG083 ■ DW390 ■ (x6)	EZ197

     						
JD319  (x2) JB925  (x6) JD250  (x6) 05/93→	JN346 (x6)	JJ546		 NF832  90x110x11mm, PTFE  NF840  150x172x13mm, FPM	PA708 [14][43]  PA709 [14]  →05/88 LB802 [14][44]  06/88→	 BW390  BW920  JB925  JD250  JD318  JD319  JN346  JJ069  JJ546
JD319  (x2) JB925  (x6) JD250  (x6) 05/93→	JN346 (x6)	JJ546		 NF832  90x110x11mm, PTFE  NF840  150x172x13mm, FPM	LB802 [14][44]  PA708 [14][43] 	
JD319  (x2) JB925  (x6) JD250  (x6) 05/93→	JN346 (x6)	JJ546		 NF840  150x172x13mm, FPM →11/85  NF839  85x110x13mm, FPM 11/85→06/88  NF832  90x110x11mm, PTFE 06/88→	PA708 (x12)[14][43]   PA709 (x18)[14]  →05/88 LB802 (x18)[14][44]   06/88→	
JD319  (x2) JB925  (x6) JD250  (x6) 05/93→	JN346 (x6)	JJ546				
JD318  (x6)		JJ069		 NA5181  110x130x13mm, PTFE		
JD319  (x2) JB925  (x6) JD250  (x6) 05/83→	JN346 (x6)	JJ546		 NF832 90x110x11mm, PTFE  NF840 150x172x13mm, FPM	PA708 [14][43]  LB802 [14][44]  06/88→	
JD319  (x2) JB925  (x6)	JN346 (x6)	JJ546				
JD319  (x2) JB925  (x6)	JN346 (x6)	JJ546		 NF832  90x110x11mm, PTFE  NF840  150x172x13mm, FPM	LB802 [14][44]  PA708 [14][43] 	
JD319  (x2) JB925  (x6) JD250  (x6) 05/93→	JN346 (x6)	JJ546		 NF832  90x110x11mm, PTFE  NF840  150x172x13mm, FPM	PA708 [14][43]  PA709 [14]  →05/88 LB802 [14][44]  06/88→	
JD319  (x2) JB925  (x6)	JN346 (x6)	JJ546				
JD319  (x2) JB925  (x6)	JN346 (x6)	JJ546		 NF832  90x110x11mm, PTFE  NF840  150x172x13mm, FPM	PA708 [14][43]  PA709 [14] 	
JD319  (x2) JB925  (x6) JD250  (x6)	JN346 (x6)	JJ546		 NF832 90x110x11mm, PTFE  NF840 150x172x13mm, FPM	LB802 [14][44]  PA708 [14][43] 	

RENAULT TRUCKS / RVI



cc





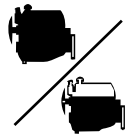



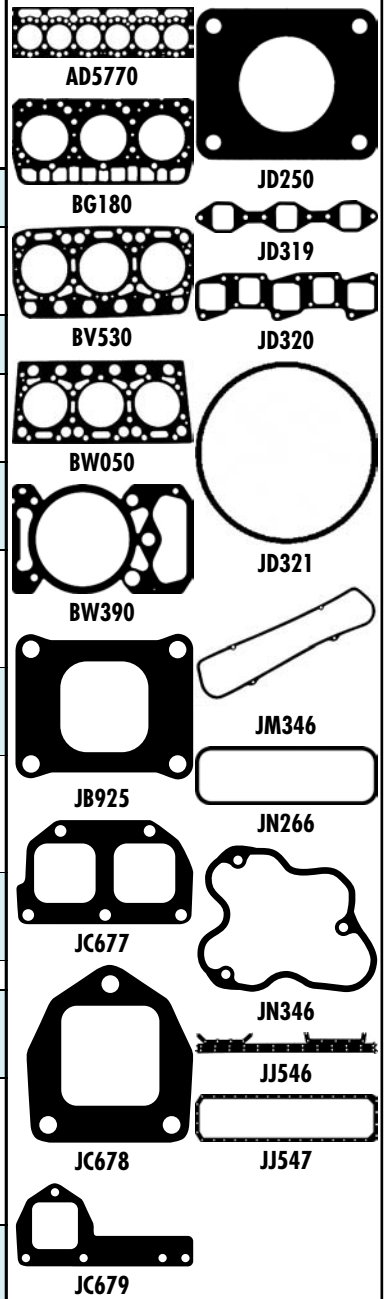

kW/PS











59	MIDS 06.20.45 J3	9840	6	120.00	Turbo	168/228	BW390 (SE) (x6)	DG083 ■ DW390 ■ (x6)	EZ197
60	MIPR 06.20.45 A	9840	6	120.00	Turbo Intercooled	210/286	BW390 (SE) (x6)		
61	MIPR 06.20.45 A3	9840	6	120.00	Turbo Intercooled	222/302	BW390 (SE)	DG083 ■ DW390 ■ (x6)	
62	dCi 11G	11100	6	123.00	Euro 3/Turbo Intercooled	230/313	AD5770 (SE)		
	dCi 11E	11100	6	123.00	Euro 3/Turbo Intercooled	266/362			
	dCi 11C	11100	6	123.00	Euro 3/Turbo Intercooled	303/412			
63	MIDR 06.23.56 A/3	11100	6	123.00	Euro 2/Turbo Intercooled	255/347	BW390 (SE) (x6)		
	MIDR 06.23.56 A/41	11100	6	123.00	Euro 2/Turbo Intercooled	280/381			
	MIDR 06.23.56 B/41	11100	6	123.00	Euro 2/Turbo Intercooled	288/392			
64	MIDR 06.35.40 C	11941	6	135.00	Turbo Intercooled	224-228/ 305-310	BV530 (SE) (x2)	DL630 →12/85 DV530 ■ 01/86→	EZ182
65	MIDR 06.35.40 H	11941	6	135.00	Turbo Intercooled	264-275/ 359-374	BV530 (SE) (x2)	DL630	EZ182
66	MIDR 06.35.40	12000	6	135.00	Turbo Intercooled	235	BG180 (Fibre), 1.35mm (x2) →10/80 BV530 (SE) (x2) 11/80→	DV530 ■ 11/80→	EZ182
67	MDS 06.35.40	12024	6	135.00	Turbo Intercooled	177/240	BV530 (SE) (x2)	DL630	EZ182
68	MIDS 06.35.40 E	12024	6	135.00	Turbo	195/265	BV530 (SE) (x2)		
69	MIDS 06.35.40 D	12024	6	135.00	Turbo	208/283	BV530 (SE) (x2)	DV530 ■	EZ182
70	MIDR 06.35.40 M3	12024	6	135.00	Euro 1/Turbo Intercooled	236/321	BW050 (SE) (x2)	DW050 ■○	EZ184
	MIDR 06.35.40 L1	12024	6	135.00	Turbo Intercooled	283/385			
	MIDR 06.35.40 N/3	12024	6	135.00	Euro 1/Turbo Intercooled	283/385			
	MIDR 06.35.40 J/3	12024	6	135.00	Euro 1/Turbo Intercooled	305/415			
	MIDR 06.35.40 J1	12024	6	135.00	Euro 1/Turbo Intercooled	314/427			
71	MIDR 06.35.40 G	12024	6	135.00	Turbo Intercooled	243-259/ 330-352	BV530 (SE) (x2)	DV530 ■ →05/88 DL630 06/88→	EZ182
72	MIDR 06.35.40 P/41	12024	6	135.00	Euro 2/Turbo Intercooled	305/415	BW050 (SE) (x2)	DW050 ■○	

JD319 ■ (x2) JB925 ■ (x6)	JN346 (x6)	JJ546				AD5770	JD250		
JD319 ■ (x2) JB925 ■ (x6) JD250 ■ (x6)	JN346 (x6)	JJ546				BG180	JD319		
JD319 ■ (x2) JB925 ■ (x6)	JN346 (x6)					BV530	JD320		
JD319 ■ (x2) JB925 ■ (x6)	JM346 (x6)					BW050	JD321		
JD319 ■ (x2) JB925 ■ (x6) JD250 ■ (x6)	JN346 (x6)	JJ546				BW390	JM346		
JD319 ■ (x2) JC677 ■ JC678 ■ JC679 ■		JJ547			<input checked="" type="checkbox"/> NF832 ■ 90x110x11mm, PTFE <input checked="" type="checkbox"/> NF831 ■ 130x150x13mm, PTFE		JN266		
JC677 ■ JC678 ■ JC679 ■	JN266 (x2)	JJ547			<input checked="" type="checkbox"/> NF832 ■ 90x110x11mm, PTFE <input checked="" type="checkbox"/> NF831 ■ 130x150x13mm, PTFE		JN266		
JC677 ■ JC678 ■ JC679 ■	JN266 (x2)	JJ547			<input checked="" type="checkbox"/> NF745 ■ 80x100x13mm <input checked="" type="checkbox"/> NF832 ■ 90x110x11mm, PTFE <input checked="" type="checkbox"/> NF831 ■ 130x150x13mm, PTFE		JN266		
JC677 ■ JC678 ■ JC679 ■	JN266 (x2)	JJ547			<input checked="" type="checkbox"/> NF745 ■ 80x100x13mm <input checked="" type="checkbox"/> NF832 ■ 90x110x11mm, PTFE <input checked="" type="checkbox"/> NF831 ■ 130x150x13mm, PTFE		JN266		
JC677 ■ JC678 ■ JC679 ■	JN266 (x2)	JJ547			<input checked="" type="checkbox"/> NF745 ■ 80x100x13mm <input checked="" type="checkbox"/> NF832 ■ 90x110x11mm, PTFE <input checked="" type="checkbox"/> NF831 ■ 130x150x13mm, PTFE		JN266		
JD320 ■ (x2) JD321 ■ (x4)	JN266 (x2)	JJ547			<input checked="" type="checkbox"/> NF832 ■ 90x110x11mm, PTFE <input checked="" type="checkbox"/> NF831 ■ 130x150x13mm, PTFE		JN266		
JC677 ■ JC678 ■ JC679 ■	JN266 (x2)	JJ547			<input checked="" type="checkbox"/> NF745 ■ 80x100x13mm <input checked="" type="checkbox"/> NF832 ■ 90x110x11mm, PTFE <input checked="" type="checkbox"/> NF831 ■ 130x150x13mm, PTFE		JN266		
JD320 ■		JJ547					JN266		



		cc			9			cc			9
D 11 LB16	Diesel	11020	6	127.00	17	DS 14 LB01/DS 14 LB06	Diesel	14200	8	127.00	36
D 11 LB18/D 11 LB20/ D 11 LB22/D 11 LB24/ D 11 LB26	Diesel	11020	6	127.00	17	DS 14 LB02/DS 14 LB07	Diesel	14200	8	127.00	36
D 11 R 23	Diesel	11022	6	127.00	26	DS 14 LB 05	Diesel	14200	8	127.00	38
D 11.01 LB24 / LB26	Diesel	11020	6	127.00	17	DS 14 LB 08	Diesel	14200	8	127.00	38
D 11.02 LB20 / LB22	Diesel	11020	6	127.00	17	DS 14.01	Diesel	14190	8	127.00	32
D 11.04 C01	Diesel	11020	6	127.00	17	DS 14.01 L 01	Diesel	14200	8	127.00	40
D 14	Diesel	14181	8	127.00	29	DS 14.01 LB08	Diesel	14200	8	127.00	36
D 8	Diesel	7800	6	115.00	3	DS 14.06	Diesel	14190	8	127.00	32
D 8 LB03	Diesel	7800	6	115.00	1	DS 14.06 L01 / L02 / L03	Diesel	14200	8	127.00	41
D 8 R 01	Diesel	7800	6	115.00	3	DS 14.07	Diesel	14190	8	127.00	32
D 8.01 B09	Diesel	7800	6	115.00	3	DS 14.07 L01/DS 14.07 L02	Diesel	14200	8	127.00	39
D 8.02 B09	Diesel	7800	6	115.00	3	DS 8	Diesel	7800	6	115.00	2
D 8-01 LB11	Diesel	7800	6	115.00	4	DS 8 LB03	Diesel	7800	6	115.00	1
DC 9.01	Diesel	9000	6	115.00	13	DS 8 LB04	Diesel	7800	6	115.00	1
DC 9.02	Diesel	9000	6	115.00	13	DS 8 LB09-LB14	Diesel	7800	6	115.00	4
DC 9.03	Diesel	9000	6	115.00	13	DS 8.01	Diesel	7800	6	115.00	2
DC 9.04	Diesel	9000	6	115.00	13	DS 8.01 B10	Diesel	7800	6	115.00	2
DC 9.05	Diesel	9000	6	115.00	13	DS 8.01 B11	Diesel	7800	6	115.00	2
DC 9.06	Diesel	9000	6	115.00	13	DS 8.01 B12	Diesel	7800	6	115.00	2
DN 11.01	Diesel	11020	6	127.00	20	DS 8.05	Diesel	7800	6	115.00	6
DN 11.01 B10	Diesel	11000	6	127.00	14	DS 8.05 B	Diesel	7800	6	115.00	2
DN 11.01 C 09	Diesel	11020	6	127.00	20	DS 8.06	Diesel	7800	6	115.00	2
DN 11.04 B10	Diesel	11000	6	127.00	14	DS 801 LB14/DS 801 LB15/ DS 801 LB16	Diesel	7800	6	115.00	4
DN 11.04 C 01	Diesel	11000	6	127.00	14	DS 9.01	Diesel	8475	6	115.00	8
DN 11.06	Diesel	11020	6	127.00	20	DS 9.01 L01 - L02/DS 9.01 L02	Diesel	8471	6	115.00	7
DN 11.06 B	Diesel	11020	6	127.00	20	DS 9.02	Diesel	8475	6	115.00	8
DN 11.06 C	Diesel	11020	6	127.00	20	DS 9.03 B 01	Diesel	8480	6	115.00	9
DN 11.07	Diesel	11022	6	127.00	25	DS 9.03 B 02	Diesel	8480	6	115.00	9
DN 11.08	Diesel	11022	6	127.00	25	DS 9.04	Diesel	8471	6	115.00	7
DN 11.08 B01	Diesel	11020	6	127.00	20	DS 9.05	Diesel	8475	6	115.00	8
DN 8 LB07/DN 8 LB09	Diesel	7800	6	115.00	4	DS 9.05 B 01	Diesel	8475	6	115.00	8
DN 8.01	Diesel	7800	6	115.00	6	DS 9.05 B 02	Diesel	8475	6	115.00	8
DN 8.05 L01 . L04	Diesel	7800	6	115.00	5	DS 9.06	Diesel	8475	6	115.00	8
DN 9	Diesel	8500	6	115.00	10	DS 9.08	Diesel	8475	6	115.00	8
DN 9.01	Diesel	8500	6	115.00	10	DSC 1401 L01	Diesel	14200	8	127.00	37
DS 11	Diesel	11022	6	127.00	27	DSC 11 01 L01 / L02	Diesel	11020	6	127.00	19
DS 11 / D11	Diesel	11022	6	127.00	26	DSC 11.01	Diesel	11020	6	127.00	19
DS 11 LB04 / LB05 / LB07	Diesel	11020	6	127.00	17	DSC 11.01 B	Diesel	11000	6	127.00	15
DS 11 LB21	Diesel	11020	6	127.00	17	DSC 11.02	Diesel	11022	6	127.00	28
DS 11.01	Diesel	11022	6	127.00	27	DSC 11.03	Diesel	11020	6	127.00	21
DS 11.01 LB21/DS 11.01 LB24	Diesel	11020	6	127.00	17	DSC 11.04	Diesel	11020	6	127.00	21
DS 11.02	Diesel	11022	6	127.00	27	DSC 11.04 C	Diesel	11020	6	127.00	19
DS 11.02 LB23 / LB26	Diesel	11020	6	127.00	17	DSC 11.06	Diesel	11020	6	127.00	23
DS 11.10	Diesel	11020	6	127.00	18	DSC 11.08	Diesel	11020	6	127.00	19
DS 11.11 LB01 / LB02	Diesel	11020	6	127.00	17	DSC 11.08 B	Diesel	11020	6	127.00	21
DS 11.14	Diesel	11022	6	127.00	25	DSC 11.08 C	Diesel	11020	6	128.00	21
DS 11.14 L01 / L02 / L03	Diesel	11020	6	127.00	19	DSC 11.10	Diesel	11020	6	127.00	19
DS 11.15	Diesel	11022	6	127.00	25	DSC 11.12	Diesel	11020	6	127.00	19
DS 11.15 B	Diesel	11022	6	127.00	27	DSC 11.13	Diesel	11020	6	127.00	19
DS 11.15 L01 / L02 / L03	Diesel	11020	6	127.00	19	DSC 11.13 B	Diesel	11020	6	127.00	21
DS 11.18	Diesel	11022	6	127.00	27	DSC 11.16	Diesel	11020	6	127.00	24
DS 11.18 L01 / L02	Diesel	11020	6	127.00	19	DSC 11.16 B	Diesel	11020	6	127.00	21
DS 11.22	Diesel	11022	6	127.00	27	DSC 11.16 B02	Diesel	11020	6	127.00	19
DS 11.23	Diesel	11022	6	127.00	27	DSC 11.17	Diesel	11020	6	127.00	19
DS 11.25	Diesel	11022	6	127.00	27	DSC 11.17 B	Diesel	11020	6	127.00	21
DS 11.34	Diesel	11020	6	127.00	22	DSC 11.18	Diesel	11020	6	127.00	19
DS 11.34 B	Diesel	11020	6	127.00	18	DSC 11.18 B	Diesel	11020	6	127.00	21
DS 11.34 B0 6	Diesel	11020	6	127.00	18	DSC 11.18 B0 1	Diesel	11020	6	127.00	19
DS 11.34 C	Diesel	11020	6	127.00	18	DSC 11.18 L01	Diesel	11020	6	127.00	21
DS 11.71	Diesel	11020	6	127.00	18	DSC 11.21	Diesel	11020	6	127.00	23
DS 11.71 C	Diesel	11020	6	127.00	22	DSC 11.22	Diesel	11020	6	127.00	21
DS 11.72	Diesel	11022	6	127.00	27	DSC 11.23	Diesel	11020	6	127.00	21
DS 11.73	Diesel	11020	6	127.00	19	DSC 11.24	Diesel	11020	6	127.00	21
DS 11.73 B	Diesel	11020	6	127.00	18	DSC 11.27 C	Diesel	11020	6	127.00	21
DS 11.74	Diesel	11020	6	127.00	18	DSC 11.27 C02	Diesel	11020	6	127.00	19
DS 11.74 C	Diesel	11020	6	127.00	22	DSC 11.27 C02	Diesel	11020	6	127.00	21
DS 11.75	Diesel	11020	6	127.00	19	DSC 11.30	Diesel	11020	6	127.00	21
DS 11.76	Diesel	11020	6	127.00	18	DSC 11.32	Diesel	11020	6	127.00	21
DS 11.77	Diesel	11020	6	127.00	18	DSC 11.33	Diesel	11020	6	127.00	21
DS 11.78	Diesel	11020	6	127.00	18	DSC 11.35	Diesel	11020	6	127.00	21
DS 14	Diesel	14181	8	127.00	30	DSC 11.36	Diesel	11020	6	127.00	21
						DSC 11.39	Diesel	11020	6	127.00	21

		CC			9			CC			9
DSC 11.70	Diesel	11020	6	127.00	21						
DSC 11.71	Diesel	11020	6	127.00	21						
DSC 11.79	Diesel	11000	6	127.00	16						
DSC 11.81	Diesel	11020	6	127.00	21						
DSC 14.01	Diesel	14190	8	127.00	32						
DSC 14.01 L02	Diesel	14200	8	127.00	39						
DSC 14.01 L03	Diesel	14200	8	127.00	39						
DSC 14.02	Diesel	14190	8	127.00	32						
DSC 14.03	Diesel	14190	8	127.00	33						
DSC 14.03 L07	Diesel	14188	8	127.00	31						
DSC 14.04	Diesel	14190	8	127.00	33						
DSC 14.05	Diesel	14190	8	127.00	33						
DSC 14.06	Diesel	14190	8	127.00	33						
DSC 14.07 L 01	Diesel	14200	8	127.00	38						
DSC 14.08	Diesel	14190	8	127.00	34						
DSC 14.09	Diesel	14190	8	127.00	34						
DSC 14.10	Diesel	14190	8	127.00	35						
DSC 14.13	Diesel	14200	8	127.00	42						
DSC 14.15	Diesel	14200	8	127.00	42						
DSC 14.16	Diesel	14190	8	127.00	32						
DSC 9.01	Diesel	8475	6	115.00	8						
DSC 9.01	Diesel	8974	6	115.00	11						
DSC 9.02	Diesel	8475	6	115.00	8						
DSC 9.07	Diesel	8475	6	115.00	8						
DSC 9.08	Diesel	8475	6	115.00	8						
DSC 9.09	Diesel	8475	6	115.00	8						
DSC 9.10	Diesel	8475	6	115.00	8						
DSC 9.11	Diesel	9000	6	115.00	12						
DSC 9.12	Diesel	9000	6	115.00	12						
DSC 9.13	Diesel	9000	6	115.00	12						
DSC 9.15	Diesel	9000	6	115.00	12						
DSI 8.01	Diesel	7800	6	115.00	6						
DSI 8.01 B	Diesel	7800	6	115.00	6						
DTC 11.01	Diesel	11020	6	127.00	21						
DTC 11.02	Diesel	11020	6	127.00	21						



21

9

2 - series 112 H/280	01/81→12/86	25
2 - series 112 H/305	01/81→12/86	25
2 - series 112 M/305	01/81→12/86	25
2 - series 82 H/210	01/81→12/86	2
2 - series 82 H/210	01/81→12/86	6
2 - series 82 M/190	10/82→03/88	2
2 - series 82 M/210	01/81→12/86	2
2 - series 82 M/210	01/81→12/86	6
2 - series 92 H/245	01/85→12/88	8
2 - series 92 H/275	01/85→12/88	8
2 - series 92 M/245	01/85→12/88	8
2 - series 92 M/275	01/85→12/88	8
2 - series R 142 E	05/80→03/88	32
2 - series R 142 H	05/80→03/88	32
2 - series R 142 M	05/80→03/88	32
2 - series T 142 E	05/80→03/88	32
3 - series 113 E/320	11/91→12/96	19
3 - series 113 E/320	11/91→12/96	23
3 - series 113 E/320	11/91→12/96	24
3 - series 113 E/360	01/90→12/96	19
3 - series 113 E/360	01/90→12/96	21
3 - series 113 E/380	01/91→12/96	21
3 - series 113 H/310	05/88→12/91	19
3 - series 113 H/310	05/88→12/91	22
3 - series 113 H/310	05/88→12/91	23
3 - series 113 H/310	01/90→12/91	19
3 - series 113 H/320	05/88→12/96	24
3 - series 113 H/320	01/90→12/96	19
3 - series 113 H/320	01/90→12/96	23
3 - series 113 H/360	05/88→12/96	19
3 - series 113 H/360	01/90→12/96	19
3 - series 113 H/360	01/90→12/96	21
3 - series 113 H/380	01/91→12/96	21
3 - series 113 M/320	05/88→12/96	24
3 - series 113 M/320	01/90→12/96	19
3 - series 113 M/320	01/90→12/96	23
3 - series 113 M/360	05/88→12/96	19
3 - series 113 M/360	01/90→12/96	19
3 - series 113 M/360	01/90→12/96	21
3 - series 113 M/380	01/91→12/96	21
3 - series 113 M/400	01/92→12/96	21
3 - series 143 E/420	01/91→12/96	34
3 - series 143 E/450	01/90→12/96	33
3 - series 143 E/450	01/90→12/96	35
3 - series 143 E/500	01/91→12/96	32
3 - series 143 E/500	01/91→12/96	34
3 - series 143 H/400	05/88→12/91	33
3 - series 143 H/420	01/91→12/96	34
3 - series 143 H/450	05/88→12/96	33
3 - series 143 H/450	01/90→12/96	35
3 - series 143 H/470	03/88→05/91	33
3 - series 143 H/500	01/91→12/96	32
3 - series 143 H/500	01/91→12/96	34
3 - series 143 M/420	01/91→12/96	34
3 - series 143 M/450	05/88→12/96	33
3 - series 143 M/450	01/90→12/96	35
3 - series 143 M/470	03/88→05/91	33
3 - series 143 M/500	01/91→12/96	32
3 - series 143 M/500	01/91→12/96	34
3 - series 93 H/220	12/91→12/96	8
3 - series 93 H/250	03/88→12/96	8
3 - series 93 H/250	01/90→12/96	8
3 - series 93 H/280	12/91→12/96	8
3 - series 93 M/210	03/88→12/91	8
3 - series 93 M/220	12/91→12/96	8
3 - series 93 M/230	03/88→12/91	8
3 - series 93 M/250	03/88→12/96	8
3 - series 93 M/250	01/90→12/96	8
3 - series 93 M/280	03/88→12/96	8
3 - series 93 M/280	01/90→12/96	8
3 - series bus K 113	11/90→	19
3 - series bus K 113	11/90→	22
3 - series bus K 113	01/91→12/97	21



21

9

3 - series bus K 113 CLB	07/90→12/96	21
3 - series bus K 93 CL	01/91→12/96	8
3 - series bus L 113 CLB	01/90→12/96	19
3 - series bus L 113 CLB	01/90→12/96	22
3 - series bus L 113 CLB	11/93→12/96	21
3 - series T 113 E/320	01/90→12/96	19
3 - series T 113 E/320	01/90→12/96	23
3 - series T 113 E/320	01/90→12/96	24
3 - series T 113 E/360	01/90→12/96	19
3 - series T 113 E/360	01/90→12/96	21
3 - series T 113 H/320	01/90→12/96	19
3 - series T 113 H/320	01/90→12/96	23
3 - series T 113 H/320	01/90→12/96	24
3 - series T 113 H/360	01/90→12/96	19
3 - series T 113 H/360	01/90→12/96	21
3 - series T 143 E/420	01/91→12/96	34
3 - series T 143 E/450	01/90→12/96	33
3 - series T 143 E/450	01/90→12/96	35
3 - series T 143 E/500	01/91→12/96	32
3 - series T 143 E/500	01/91→12/96	34
3 - series T 143 H/420	01/91→12/96	34
3 - series T 143 H/450	01/90→12/96	33
3 - series T 143 H/450	01/90→12/96	35
3 - series T 143 H/500	01/91→12/96	32
3 - series T 143 H/500	01/91→12/96	34
3 - series T 93 H/250	01/90→12/96	8
3 - series T 93 H/280	12/91→12/96	8
4 - series 114 C/340	05/96→	16
4 - series 114 G/340	05/96→	16
4 - series 114 L/340	05/96→	16
4 - series 114 L/530		42
4 - series 144 C/460	09/96→	42
4 - series 144 C/530	09/96→	42
4 - series 144 G/460	04/96→	42
4 - series 144 G/530	04/96→	42
4 - series 144 L/460		42
4 - series 144 L/530	11/95→	42
4 - series 94 G/260		12
4 - series 94 C/260	12/96→	12
4 - series 94 C/260	12/96→	13
4 - series 94 C/300		13
4 - series 94 C/310	08/96→	12
4 - series 94 D/220		12
4 - series 94 D/230		13
4 - series 94 D/230	08/99→	13
4 - series 94 D/260		12
4 - series 94 D/260		13
4 - series 94 D/300		13
4 - series 94 D/310		12
4 - series 94 D/310	12/96→	12
4 - series 94 G/220	08/96→	12
4 - series 94 G/260		12
4 - series 94 G/310		12
4 - series 94 G/310	08/96→	12
4 - series 94 L/310		12
4 - series 94 L/310	08/96→	12
4 - series T 114 G/340	05/96→	16
4 - series T 114 L/340	05/96→	16
4 - series T 144 C/460	09/95→	42
4 - series T 144 C/530	09/95→	42
4 - series T 144 G/460	03/97→	42
4 - series T 144 G/530	03/97→	42
4 - series T 144 L/42	09/95→	42
4 - series T 144 L/460	09/95→	42
4 - series T 144 L/530	09/95→	42
4 - series T 94 C/260	12/96→	12
4 - series T 94 C/310	09/96→	12
4 - series T 94 C260	12/96→	12
4 - series T 94 G/220	08/96→	12
4 - series T 94 G/230	04/99→	13
4 - series T 94 G/260	12/96→	12
4 - series T 94 G/310	09/96→	12
4 - series T 94 G/310	12/96→	12



21

9



21

9

4 - series T 94 G/310	12/96→	13
4 - series T 94 L/310	09/96→	12
4 - series T G/230	04/99→	13
40 A20		10
40 A26		10
41 A20		10
41 A26		10
985	→12/75	1
985	01/75→12/80	4
985	01/75→12/82	4
985	01/81→12/86	5
B86	01/75→12/82	4
BF86	01/75→12/82	4
BR86	01/75→12/82	4
BR112DH		17
G82M	01/86→12/88	7
G92H	01/85→	7
G92M	01/85→	7
G112E	01/81→	19
G112H	01/81→	19
G112M	01/81→	19
Industrial		19
K 445	01/81→12/88	39
K414	→12/75	1
K414	01/75→12/80	4
K414	01/77→12/80	17
K414	01/81→	19
K414B	→12/75	1
K414B	01/75→12/80	4
K414B	01/77→12/80	17
K414B	01/81→	19
K420	01/77→12/80	17
K420	01/81→	19
K424	01/77→12/80	17
K424	01/81→	19
K425	01/77→12/80	17
K425	01/81→	19
K425B	01/77→12/80	17
K425B	01/81→	19
K435	01/77→12/80	17
K435	01/81→	19
K445	01/77→12/80	36
LB80	→12/75	1
LB81	01/75→12/80	4
LB81	01/75→12/82	4
LB85	→12/75	1
LB86	01/75→12/80	4
LB86	01/75→12/82	4
LB110	01/74→12/77	17
LB111	01/77→12/80	17
LB140	01/75→	36
LB140H	01/75→12/76	36
LB141	01/77→12/80	36
LBS85	→12/75	1
LBS86	01/75→12/80	4
LBS86	01/75→12/82	4
LBS110	01/74→12/77	17
LBS111	01/77→12/80	17
LBS140	01/75→	36
LBS140H	01/75→12/76	36
LBS141	01/77→12/80	36
LBT110	01/74→12/77	17
LBT111	01/77→12/80	17
LBT140	01/75→	36
LBT140H	01/75→12/76	36
LBT141	01/77→12/80	36
N113CLB	01/91→	19
P,G,R,T - series P 230		13
P,G,R,T - series P 260		13
P,G,R,T - series P 300		13
P82M	01/75→12/82	4
P82M	01/81→12/86	5
P82M	01/86→12/88	7

P92H	01/85→	7
P92HB	01/85→	7
P92M	01/85→	7
P92MA	01/85→	7
P112E	01/81→	19
P112H	01/81→	19
P112M	01/81→	19
Parca 714	→12/75	1
Parca 714	01/75→12/80	4
Parca 714	01/75→12/82	4
Parca 714	01/81→12/86	5
R 142E	01/81→12/88	39
R 142H	01/81→12/88	39
R 142M	01/81→12/88	39
R 142MA	01/81→12/88	39
R92H	01/85→	7
R92M	01/85→	7
R112E	01/81→	19
R112H	01/81→	19
R112M	01/81→	19
R142E	01/81→12/88	39
R142H	01/81→12/88	39
R142M	01/77→12/80	36
R142M	01/81→12/88	39
R142MA	01/77→12/80	36
R142MA	01/81→12/88	39
T 142H	01/81→12/88	39
T82H	01/81→12/86	5
T82M	01/81→12/86	5
T112E	01/77→12/80	17
T112E	01/81→	19
T112H	01/77→12/80	17
T112H	01/81→	19
T142E	01/80→12/88	37
T142H	01/77→12/80	36
T142H	01/80→12/88	37
T142H	01/81→12/88	39
Tvigg	→12/75	1
Tvigg	01/75→12/80	4
Tvigg	01/75→12/82	4
Tvigg	01/81→12/86	5



cc



kW/PS

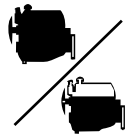

1	D 8 LB03	7800	6	115.00			AG450 (Fibre) (x3)[45]	CG450 ■○ (x3)	
	DS 8 LB03	7800	6	115.00	Turbo				
	DS 8 LB04	7800	6	115.00					
2	DS 8.05 B	7800	6	115.00			BE940 (Steel) (x3)[45]	CZ030 ○ (x3)	
	DS 8.06	7800	6	115.00	Turbo	140/190			
	DS 8.01	7800	6	115.00	Turbo	154-170/ 209-231			
	DS 8	7800	6	115.00	Turbo	154-160/ 210-218			
	DS 8.01 B10/DS 8.01 B11/ DS 8.01 B12	7800	6	115.00	Turbo	154/210			
3	D 8 R 01	7800	6	115.00		107/145	BE940 (Steel) (x3)[45]	CZ030 ○ (x3)	FZ030 ○ [36]
	D 8.01 B09/D 8.02 B09	7800	6	115.00		114/155			
	D 8	7800	6	115.00		115-120/ 157-163			
4	D 8-01 LB11/DN 8 LB07/ DN 8 LB09	7800	6	115.00		120/163	BE940 (Steel) (x3)[45]	CZ030 ○ (x3)	FZ030 ○ [36]
	DS 801 LB14/DS 801 LB15/ DS 801 LB16	7800	6	115.00	Turbo	120/163			
	DS 8 LB09-LB14	7800	6	115.00	Turbo	140/ 148.5/ 190/202			
5	DN 8.05 L01 . L04	7800	6	115.00		120/163	BE940 (Steel) (x3)[45]	CZ030 ○ (x3)	
6	DN 8.01	7800	6	115.00		123/167	BE940 (Steel) (x3)[45]	CZ030 ○ (x3)	
	DS 8.05	7800	6	115.00	Turbo	155/211			
	DSI 8.01 B	7800	6	115.00	Turbo Intercooled	170/231			
	DSI 8.01	7800	6	115.00	Turbo Intercooled	178/242			
7	DS 9.04	8471	6	115.00	Turbo	150/204	BT570 (SE) (x6)[45]	DT570 ○ HL605 (x6)	GT570 ○ [36]
	DS 9.01 L01 - L02/ DS 9.01 L02	8471	6	115.00	Turbo	180/202			
8	DS 9.08	8475	6	115.00	Turbo	150/204	BT570 (SE) (x6)[45]	DT570 ○ HL605 (x6)	GT570 ○ [36]
	DS 9.02	8475	6	115.00	Turbo	162- 180/220/ 245			
	DSC 9.10	8475	6	115.00	Euro 1/Turbo Intercooled	162/220			
	DS 9.05	8475	6	115.00	Turbo	167/187/ 220/246			
	DS 9.06	8475	6	115.00	Turbo	167/227			
	DS 9.01	8475	6	115.00	Turbo	180-185/ 245-252			
	DS 9.05 B 01/DS 9.05 B 02	8475	6	115.00	Turbo	181/246			
	DSC 9.09	8475	6	115.00	Euro 2/Turbo Intercooled	184/250			
	DSC 9.07	8475	6	115.00	Euro 1/Turbo Intercooled	185/252			
	DSC 9.01	8475	6	115.00	Turbo Intercooled	202/275			
	DSC 9.02	8475	6	115.00	Turbo Intercooled	207/282			
DSC 9.08	8475	6	115.00	Euro 1/Turbo Intercooled	208/283				
9	DS 9.03 B 01/DS 9.03 B 02	8480	6	115.00	Turbo	150/204	BT570 (SE) (x6)[45]	DT570 ○ HL605 (x6)	GT570 ○ [36]
10	DN 9	8500	6	115.00			BT570 (SE) (x6)[45]	DT570 ○ HL605 (x6)	GT570 ○ [36]
	DN 9.01	8500	6	115.00		150/204			
11	DSC 9.01	8974	6	115.00	Euro 3/Turbo Intercooled	169/230	BT570 (SE) (x6)[45]	DT570 ○ HL605 (x6)	GT570 ○ [36]
12	DSC 9.11	9000	6	115.00	Euro 2/Turbo Intercooled	162/220	BT570 (SE) (x6)[45]	DT570 ○ HL605 (x6)	GT570 ○ [36]
	DSC 9.12	9000	6	115.00	Euro 2/Turbo Intercooled	191/260			
	DSC 9.13/DSC 9.15	9000	6	115.00	Euro 2/Turbo Intercooled	228/310			

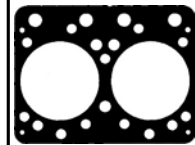
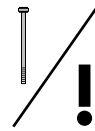
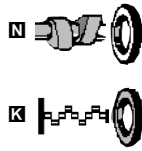
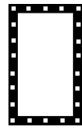
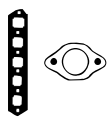

AG450

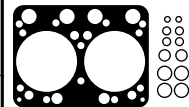

BE940

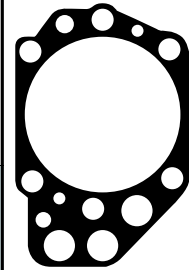

BT570



JN333



JJ137

	JN333 (x3)	JJ137			
	JN333 (x3)	JJ137		<input checked="" type="checkbox"/> NB618 <input checked="" type="checkbox"/> NB619	HT013 (x6)[14]
	JN333 (x3)	JJ137		<input checked="" type="checkbox"/> NB618 <input checked="" type="checkbox"/> NB619	HT013 (x6)[14]
	JN333 (x3)	JJ137		<input checked="" type="checkbox"/> NB618 <input checked="" type="checkbox"/> NB619	HT013 (x6)[14]
	JN333 (x3)			<input checked="" type="checkbox"/> NB618 <input checked="" type="checkbox"/> NB619	HT013 (x6)[14]
	JN333 (x3)	JJ137		<input checked="" type="checkbox"/> NB618 <input checked="" type="checkbox"/> NB619	HT013 (x6)[14]
		HC474		<input checked="" type="checkbox"/> NB618 <input checked="" type="checkbox"/> NB619	HT014 (x6)[14]
		HC474		<input checked="" type="checkbox"/> NB618 <input checked="" type="checkbox"/> NB619	HT014 (x6)[14]
		HC474		<input checked="" type="checkbox"/> NB618 <input checked="" type="checkbox"/> NB619	HT014 (x6)[14]
		HC474		<input checked="" type="checkbox"/> NB618 <input checked="" type="checkbox"/> NB619	HT014 (x6)[14]
		HC474		<input checked="" type="checkbox"/> NB618 <input checked="" type="checkbox"/> NB619	HT014 (x6)[14]
		HC474		<input checked="" type="checkbox"/> NB618 <input checked="" type="checkbox"/> NB619	HT014 (x6)[14]



cc



kW/PS

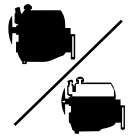

13	DC 9.01/DC 9.04	9000	6	115.00	Euro 3/Turbo Intercooled	169/230	BT570 (SE) (x6) [45]			
	DC 9.02/DC 9.05	9000	6	115.00	Euro 3/Turbo Intercooled	191/260				
	DC 9.03	9000	6	115.00	Euro 3/Turbo Intercooled	221/300				
	DC 9.06	9000	6	115.00	Turbo Intercooled	221/300				
14	DN 11.01 B10/ DN 11.04 B10/ DN 11.04 C 01	11000	6	127.00			BG660 (Steel) (x2) [45] →12/79 BS560 (SE) (x2) 01/80→	DS560 ■○ (x2)	GB131 ○ [36]	
15	DSC 11.01 B	11000	6	127.00	Turbo Intercooled		BG660 (Steel) (x2) [45] →12/79 BS560 (SE) (x2) 01/80→	DS560 ■○ (x2) DS561 ○ (x2)		
16	DSC 11.79	11000	6	127.00		250/340	BG660 (Steel) (x2) [45] BS560 (SE) (x2)			
17	DS 11 LB04 / LB05 / LB07	11020	6	127.00	Turbo	149/203	BG660 (Steel) (x2) [45] →12/79 BS560 (SE) (x2) 01/80→	DB130 ■○ (x2) DS560 ■○ (x2) →Eng.4070104 DS561 ○ (x2) Eng.4070104→	GB130 ○ [36]	
	D 11 LB16/D 11 LB18/ D 11 LB20/D 11 LB22/ D 11 LB24/D 11 LB26/ D 11.01 LB24 / LB26/ D 11.02 LB20 / LB22/ D 11.04 C01	11020	6	127.00						
	DS 11.02 LB23 / LB26/ DS 11.11 LB01 / LB02	11020	6	127.00	Turbo					203/245/ 275/333
	DS 11 LB21	11020	6	127.00	Turbo					203/276
	DS 11.01 LB21/ DS 11.01 LB24	11020	6	127.00	Turbo					203/245/ 276/333
18	DS 11.77	11020	6	127.00		189/257	AZ020 (Fibre) (x2) →12/74 BG660 (Steel) (x2) [45] →12/79 BS560 (SE) (x2) 01/80→	CZ020 ■○ (x2) DB130 ■○ (x2) DS560 ■○ (x2) DS561 ○ (x2)	GB130 ○ [36] GB131 ○ [36]	
	DS 11.71	11020	6	127.00	Turbo					
	DS 11.76	11020	6	127.00	Turbo					
	DS 11.74	11020	6	127.00	Turbo					
	DS 11.78	11020	6	127.00	Turbo Intercooled					
	DS 11.34 B/DS 11.34 C	11020	6	127.00	Turbo					
	DS 11.34 B0 6/DS 11.73 B	11020	6	127.00	Turbo					
DS 11.10	11020	6	127.00	Turbo						
19	DSC 11.16 B02	11020	6	127.00		180-200/ 245-272	BG660 (Steel) (x2) [45] BS560 (SE) (x2)	DB131 ○ (x2) DS560 ■○ (x2) →Eng.4070104 DS561 ○ (x2) Eng.4070104→	GB131 ○ [36]	
	DSC 11.27 C02	11020	6	127.00	Turbo Intercooled					
	DSC 11.04 C	11020	6	127.00	Turbo Intercooled					
	DS 11.14 L01 / L02 / L03/ DS 11.15 L01 / L02 / L03/ DS 11.18 L01 / L02	11020	6	127.00	Turbo					
	DSC 11 01 L01 / L02	11020	6	127.00	Turbo Intercooled					
	DSC 11.12	11020	6	127.00	Turbo Intercooled					
	DS 11.73/DS 11.75	11020	6	127.00	Turbo					
	DSC 11.08	11020	6	127.00	Turbo Intercooled					
	DSC 11.01	11020	6	127.00	Turbo Intercooled					
	DSC 11.17	11020	6	127.00	Turbo Intercooled					
	DSC 11.18 B0 1	11020	6	127.00	Turbo Intercooled					
	DSC 11.13/DSC 11.18	11020	6	127.00	Turbo Intercooled					
	DSC 11.10	11020	6	127.00	Turbo Intercooled					
										203/245/ 275/333
					227/260/ 310/354					
					228-230/ 310-313					
					228/310					
					230/313					
					237/322					
					265/360					
					267/363					
					280/381					

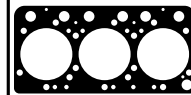
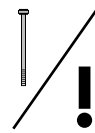
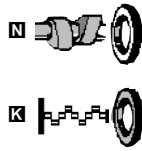
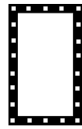
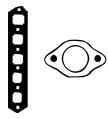

AZ020



BG660

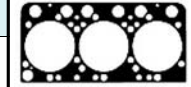

BS560

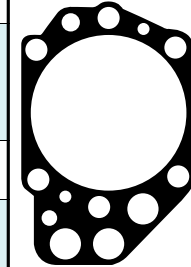

BT570

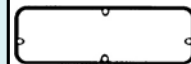

JN314

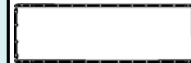

JJ138

	JN314 (x2)	JJ138		<input checked="" type="checkbox"/> NB618 <input checked="" type="checkbox"/> NB619	HT015 (x6) [14]
	JN314 (x2)			<input checked="" type="checkbox"/> NB618 <input checked="" type="checkbox"/> NB619	HT015 (x6) [14]
	JN314 (x2)			<input checked="" type="checkbox"/> NB618 <input checked="" type="checkbox"/> NB619	HT015 (x6) [14]
	JN314 (x2)	JJ138		<input checked="" type="checkbox"/> NB618 <input checked="" type="checkbox"/> NB619	HT016 (x6) [14]
	JN314 (x2)	JJ138		<input checked="" type="checkbox"/> NB618 <input checked="" type="checkbox"/> NB619	HT015 (x6) [14]
	JN314 (x2)	JJ138		<input checked="" type="checkbox"/> NB618 <input checked="" type="checkbox"/> NB619	HT016 (x6) [14]



cc



kW/PS

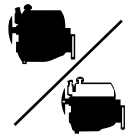

20	DN 11.06	11020	6	127.00		134/182	BG660 (Steel) (x2) [45] →12/79 BS560 (SE) (x2) 01/80→	DB131 ○ (x2) DS560 ■ ○ (x2)	GB131 ○ [36]
	DN 11.06 C	11020	6	127.00		143-149/ 194-203			
	DN 11.06 B	11020	6	127.00		143/195			
	DN 11.01	11020	6	127.00		149-153/ 203-208			
	DN 11.08 B01	11020	6	127.00		149/203			
DN 11.01 C 09	11020	6	127.00		158/215				
21	DSC 11.27 C02	11020	6	127.00	Turbo Intercooled	180-200/ 245-272	BG660 (Steel) (x2) [45] BS560 (SE)	DB131 ○ (x2) DS560 ■ ○ (x2) →Eng.4070104 DS561 ○ (x2) Eng.4070104→	GB131 ○ [36]
	DSC 11.04	11020	6	127.00	Turbo Intercooled	189-245/ 257-333			
	DSC 11.27 C	11020	6	127.00	Turbo Intercooled	189/257			
	DSC 11.24	11020	6	127.00	Euro 2/Turbo Intercooled	191/260			
	DSC 11.08 B	11020	6	127.00	Turbo Intercooled	228/310			
	DSC 11.17 B/DSC 11.32	11020	6	127.00	Turbo Intercooled	235/320			
	DSC 11.35/DSC 11.36/ DSC 11.71	11020	6	127.00	Turbo Intercooled	235-266/ 320-362			
	DSC 11.16 B	11020	6	127.00	Turbo Intercooled	239/325			
	DSC 11.03	11020	6	127.00	Turbo Intercooled	254/345			
	DSC 11.39	11020	6	127.00	Euro 1/Turbo Intercooled	258/351			
	DSC 11.30	11020	6	127.00	Turbo Intercooled	265-280/ 360-381			
	DSC 11.23	11020	6	127.00	Euro 1/Turbo Intercooled	266/362			
	DSC 11.33	11020	6	127.00	Turbo Intercooled	266/362			
	DSC 11.18 L01	11020	6	127.00	Turbo Intercooled	267/360			
	DSC 11.13 B/DSC 11.18 B	11020	6	127.00	Turbo Intercooled	267/363			
	DSC 11.22	11020	6	127.00	Bi-Turbo Intercooled	280/381			
	DSC 11.70	11020	6	127.00	Turbo Intercooled	280/381			
	DTC 11.01	11020	6	127.00	Euro 1/Turbo Intercooled	295/401			
	DTC 11.02	11020	6	127.00	Euro 2/Turbo Intercooled	295/401			
	DSC 11.81	11020	6	127.00	Turbo Intercooled	305/415			
DSC 11.08 C	11020	6	128.00	Turbo Intercooled	228/310				
22	DS 11.71 C/DS 11.74 C	11020	6	127.00	Turbo	189/257	BG660 (Steel) (x2) [45] →12/79 BS560 (SE) (x2) 01/80→	DB131 ○ (x2) DS560 ■ ○ (x2) →Eng.4070104 DS561 ○ (x2) Eng.4070104→	GB131 ○ [36]
	DS 11.34	11020	6	127.00	Turbo Intercooled	228/310			
23	DSC 11.06	11020	6	127.00	Turbo Intercooled	229/311	AZ020 (Fibre) (x2) BG660 (Steel) (x2) [45] BS560 (SE) (x2)	CZ020 ■ ○ (x2) DB131 ○ (x2) DS560 ■ ○ (x2) →Eng.4070104 DS561 ○ (x2) Eng.4070104→	GB131 ○ [36]
	DSC 11.21	11020	6	127.00	Euro 1/Turbo Intercooled	235-266/ 320-362			
24	DSC 11.16	11020	6	127.00	Turbo Intercooled	239/325	BG660 (Steel) (x2) [45] BS560 (SE) (x2)	DB131 ○ (x2) DS560 ■ ○ (x2) →Eng.4070104 DS561 ○ (x2) Eng.4070104→	GB131 ○ [36]
25	DN 11.07	11022	6	127.00		139/189	BG660 (Steel) (x2) [45] →12/79 BS560 (SE) (x2) 01/80→	DB131 ○ (x2) DS560 ■ ○ (x2)	GB131 ○ [36]
	DN 11.08	11022	6	127.00		150/204			
	DS 11.14	11022	6	127.00	Turbo Intercooled	206-245/ 280-333			
	DS 11.15	11022	6	127.00	Turbo Intercooled	224-245/ 305-333			

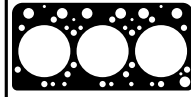
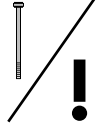
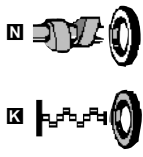
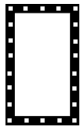
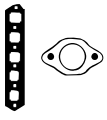

AZ020



BG660

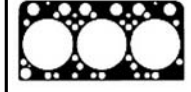

BS560

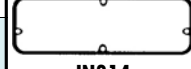

JN314

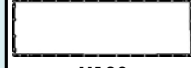

JJ138

	JN314 (x2)	JJ138		<input checked="" type="checkbox"/> NB618 <input checked="" type="checkbox"/> NB619	HT015 (x6)[14]
	JN314 (x2)	JJ138		<input checked="" type="checkbox"/> NB618 <input checked="" type="checkbox"/> NB619	HT015 (x6)[14]
	JN314 (x2)	JJ138		<input checked="" type="checkbox"/> NB618 <input checked="" type="checkbox"/> NB619	HT016 (x6)[14]
	JN314 (x2)	JJ138		<input checked="" type="checkbox"/> NB618 <input checked="" type="checkbox"/> NB619	HT015 (x6)[14]
	JN314 (x2)	JJ138		<input checked="" type="checkbox"/> NB618 <input checked="" type="checkbox"/> NB619	HT015 (x6)[14]
	JN314 (x2)	JJ138		<input checked="" type="checkbox"/> NB618 <input checked="" type="checkbox"/> NB619	HT015 (x6)[14]



cc



kW/PS

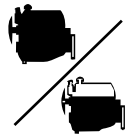

26	DS 11 / D11	11022	6	127.00		140-149/ 190-203	AZ020 (Fibre) (x2) →12/74	CZ020 ■ (x2) DB130 ■ (x2)	GB130 ○ [36]
	D 11 R 23	11022	6	127.00		143/195	BG660 (Steel) (x2) [45] →12/79 B5560 (SE) (x2) 01/80→		
27	DS 11/DS 11.01	11022	6	127.00	Turbo	184-202/ 250-275	AZ020 (Fibre) (x2) →12/74	CZ020 ■ (x2) DB130 ■ (x2) DS560 ■ (x2) →Eng.4070104 DS561 ○ (x2) Eng.4070104→	GB130 ○ [36] GB131 ○ [36]
	DS 11.25	11022	6	127.00	Turbo	185-189/ 252-260	BG660 (Steel) (x2) [45] →12/79		
	DS 11.02	11022	6	127.00	Turbo Intercooled	206-245/ 280-333	B5560 (SE) (x2) 01/80→		
	DS 11.15 B	11022	6	127.00	Turbo Intercooled	224/305			
	DS 11.72	11022	6	127.00	Turbo	230/313			
	DS 11.18	11022	6	127.00	Turbo Intercooled	254/345			
	DS 11.23	11022	6	127.00	Turbo	266/362			
	DS 11.22	11022	6	127.00	Turbo	280/381			
28	DSC 11.02	11022	6	127.00	Turbo Intercooled	267/363	BG660 (Steel) (x2) [45] B5560 (SE) (x2)	DS560 ■ (x2) →Eng.4070104 DS561 ○ (x2) Eng.4070104→	
29	D 14	14181	8	127.00	V	202/275	BV270 (Steel) (x8)	DB140 ■ (x8) [46]	GB140 ○ [36]
30	DS 14	14181	8	127.00	Turbo/V	257/350	BV270 (Steel) (x8)	DB140 ■ (x8) [46]	GB140 ○ [36] GB141 ○ [36] [47]
31	DSC 14.03 L07	14188	8	127.00	Turbo Intercooled/V	331/450	BV270 (Steel) (x8)	DB140 ■ (x8) [46]	GB141 ○ [36] [47]
32	DS 14.01	14190	8	127.00	Turbo/V	283-293/ 385-398	BV270 (Steel) (x8)	DB140 ■ (x8) [46]	GB141 ○ [36] [47]
	DS 14.06	14190	8	127.00	Turbo/V	285-291/ 388-396			
	DS 14.07	14190	8	127.00	Turbo/V	293/398			
	DSC 14.02	14190	8	127.00	Turbo Intercooled/V	301/409			
	DSC 14.01	14190	8	127.00	Turbo Intercooled/V	309/420			
	DSC 14.16	14190	8	127.00	Euro 1/Turbo Intercooled/V	368/500			
33	DSC 14.05	14190	8	127.00	Turbo Intercooled/V	290/394	BE950 (Steel) (x8) [45] →Eng.05544299 BV270 (Steel) (x8) Eng.05544299→	DB140 ■ (x8) [46] DV270 ○ (x8) [47] Eng.05544299→	GB141 ○ [36] [47]
	DSC 14.06	14190	8	127.00	Turbo Intercooled/V	309/420			
	DSC 14.03	14190	8	127.00	Turbo Intercooled/V	320/337/ 346/435/ 458/470			
	DSC 14.04	14190	8	127.00	Turbo Intercooled/V	346/470			
34	DSC 14.08	14190	8	127.00	Euro 1/Turbo Intercooled/V	309-331/ 420-450	BV270 (Steel) (x8) Eng.05544299→	DV270 ○ (x8) [47] Eng.05544299→	GB141 ○ [36] [47]
	DSC 14.09	14190	8	127.00	Euro 1/Turbo Intercooled/V	368/500			
35	DSC 14.10	14190	8	127.00	Euro 1/Turbo Intercooled/V	333-346/ 453-471	BV270 (Steel) (x8) Eng.05544299→	DV270 ○ (x8) [47] Eng.05544299→	GB141 ○ [36] [47]
36	DS 14 LB01/DS 14 LB06	14200	8	127.00	Turbo/V	309/316	BE950 (Steel) (x8) [45]	DB140 ■ (x8) [46]	GB140 ○ [36]
	DS 14 LB02/DS 14 LB07	14200	8	127.00	Turbo/V				
	DS 14.01 LB08	14200	8	127.00	Turbo/V				
37	DSC 1401 L01	14200	8	127.00	Turbo Intercooled/V		BE950 (Steel) (x8) [45] BV270 (Steel) (x8)	DB140 ■ (x8) [46] DV270 ○ (x8) [47]	GB141 ○ [36] [47]
38	DS 14 LB 05	14200	8	127.00	Turbo/V	257/350	BV270 (Steel) (x8)	DB140 ■ (x8) [46] DV270 ○ (x8) [47]	GB141 ○ [36] [47]
	DS 14 LB 08	14200	8	127.00	Turbo/V	276/375			
	DSC 14.07 L 01	14200	8	127.00	Turbo Intercooled/V	298/405			
39	DS 14.07 L01/DS 14.07 L02	14200	8	127.00	Turbo/V	276	BE950 (Steel) (x8) [45] BV270 (Steel) (x8) Eng.05544299→	DB140 ■ (x8) [46] DV270 ○ (x8) [47] Eng.05544299→	GB141 ○ [36] [47]
	DSC 14.01 L02/ DSC 14.01 L03	14200	8	127.00	Turbo Intercooled/V	309			

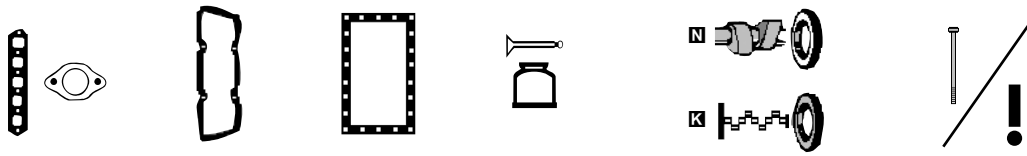

	JN314 (x2)	JJ138		<input checked="" type="checkbox"/> NB618 <input checked="" type="checkbox"/> NB619	HT015 (x6)[14]	 AZ020 BE950 BG660 BS560 BV270 JN314 JN322 JJ138
	JN314 (x2)	JJ138		<input checked="" type="checkbox"/> NB618 <input checked="" type="checkbox"/> NB619	HT015 (x6)[14]	
	JN314 (x2)			<input checked="" type="checkbox"/> NB618 <input checked="" type="checkbox"/> NB619	HT015 (x6)[14]	
	JN322 (x8)	HC475		<input checked="" type="checkbox"/> NB618 <input checked="" type="checkbox"/> NB619	HT015 (x8)[14]	
	JN322 (x8)	HC475		<input checked="" type="checkbox"/> NB618 <input checked="" type="checkbox"/> NB619	HT015 (x8)[14]	
	JN322 (x8)	HC475		<input checked="" type="checkbox"/> NB618 <input checked="" type="checkbox"/> NB619	HT015 (x8)[14]	
	JN322 (x8)	HC475		<input checked="" type="checkbox"/> NB618 <input checked="" type="checkbox"/> NB619	HT015 (x8)[14]	
	JN322 (x8)	HC475		<input checked="" type="checkbox"/> NB618 <input checked="" type="checkbox"/> NB619	HT017 (x8)[14]	
	JN322 (x8)	HC475		<input checked="" type="checkbox"/> NB618 <input checked="" type="checkbox"/> NB619	HT017 (x8)[14]	
	JN322	HC475		<input checked="" type="checkbox"/> NB618 <input checked="" type="checkbox"/> NB619	HT017 (x8)[14]	
	JN322 (x8)			<input checked="" type="checkbox"/> NB618 <input checked="" type="checkbox"/> NB619	HT017 (x8)[14]	
	JN322 (x8)	HC475		<input checked="" type="checkbox"/> NB618 <input checked="" type="checkbox"/> NB619	HT017 (x8)[14]	
	JN322 (x8)	HC475		<input checked="" type="checkbox"/> NB618 <input checked="" type="checkbox"/> NB619	HT015 (x8)[14]	
	JN322 (x8)	HC475		<input checked="" type="checkbox"/> NB618 <input checked="" type="checkbox"/> NB619	HT017 (x8)[14]	



cc









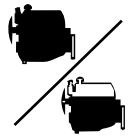



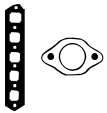

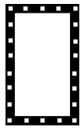

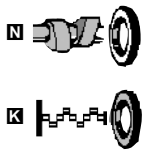
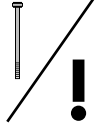
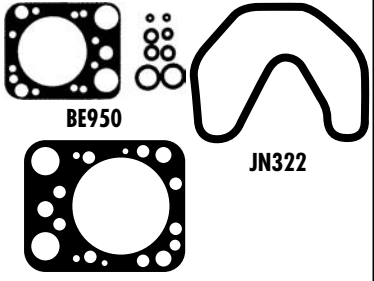

Ø



















kW/PS



40	DS 14.01 L01	14200	8	127.00	Turbo/V	276/375	BE950 (Steel) (x8)[45] →Eng.05544299 BV270 (Steel) (x8) Eng.05544299→	DB140 ■○ (x8)[46] DV270 ○ (x8)[47]	GB141 ○ [36][47]
41	DS 14.06 L01 / L02 / L03	14200	8	127.00	Turbo/V	276/285/ 291/375/ 388/396	BE950 (Steel) (x8)[45] →Eng.05544299 BV270 (Steel) (x8) Eng.05544299→	DB140 ■○ (x8)[46] DV270 ○ (x8)[47] Eng.05544299→	GB141 ○ [36][47]
42	DSC 14.15 DSC 14.13	14200 14200	8 8	127.00 127.00	Euro 3/Turbo Intercooled/V Euro 2/Turbo Intercooled/V	338/460 390/530	BV270 (Steel) (x8)	DB140 ■○ (x8)[46]	

						 <p>BE950</p> <p>JN322</p> <p>BV270</p>
	JN322 (x8)	HC475 		<input checked="" type="checkbox"/> NB618  <input checked="" type="checkbox"/> NB619 	HT017 (x8)[14] 	
	JN322 (x8)	HC475 		<input checked="" type="checkbox"/> NB618  <input checked="" type="checkbox"/> NB619 	HT017 (x8)[14] 	
	JN322 (x8)	HC475 		<input checked="" type="checkbox"/> NB618  <input checked="" type="checkbox"/> NB619 	HT015 (x8)[14] 	

		cc			9			cc			9
D 100 A	Diesel	9600	6	120.64	26	TD 120 A	Diesel	12000	6	130.17	49
D 100 B	Diesel	9600	6	120.64	23	TD 120 C	Diesel	12000	6	130.17	49
D 50 A	Diesel	5100	6	95.25	1	TD 120 D	Diesel	11980	6	130.17	45
D 50 B	Diesel	5100	6	95.25	1	TD 120 E	Diesel	11980	6	130.17	45
D 60	Diesel	5480	6	98.43	3	TD 120 F	Diesel	11980	6	130.17	45
D 7 B260	Diesel	6700	6	104.78	15	TD 120 FA	Diesel	11980	6	130.17	44
D 70 A	Diesel	6700	6	104.78	10	TD 120 FB	Diesel	11980	6	130.17	44
D 70 B	Diesel	6700	6	104.78	10	TD 120 FC	Diesel	11980	6	130.17	45
D100B	Diesel	9600	6	120.64	23	TD 120 G	Diesel	11980	6	130.17	45
D100BHC	Diesel	9600	6	120.64	23	TD 120 GA	Diesel	11980	6	130.17	45
D100BRC	Diesel	9600	6	120.64	23	TD 120 GG	Diesel	11977	6	130.17	42
D10A320	Diesel	9600	6	120.64	39	TD 121 F	Diesel	11980	6	130.17	45
D10A360	Diesel	9600	6	120.64	39	TD 121 FA	Diesel	11980	6	130.17	43
D12A340	Diesel	12100	6	131.00	50	TD 121 FB	Diesel	11980	6	130.17	43
D12A380	Diesel	12110	6	131.00	51	TD 121 FC	Diesel	11980	6	130.17	43
D12A420	Diesel	12100	6	131.00	50	TD 121 FD	Diesel	11980	6	130.17	45
D12C340	Diesel	12100	6	131.00	50	TD 121 FE	Diesel	11980	6	130.17	43
D12C380	Diesel	12100	6	131.00	50	TD 121 FF	Diesel	11980	6	130.17	43
D12C420	Diesel	12100	6	131.00	50	TD 121 FK	Diesel	11980	6	130.17	46
D12C460	Diesel	12100	6	131.00	50	TD 121 G	Diesel	11980	6	130.17	46
D12D340	Diesel	12100	6	131.00	50	TD 121 GD	Diesel	11980	6	130.17	46
D12D380	Diesel	12100	6	131.00	50	TD 122 F	Diesel	11980	6	130.17	47
D12D420	Diesel	12100	6	131.00	50	TD 122 FA	Diesel	11980	6	130.17	47
D12D460	Diesel	12100	6	131.00	50	TD 122 FH	Diesel	11980	6	130.17	47
D12D500	Diesel	12100	6	131.00	50	TD 122 FK	Diesel	11980	6	130.17	47
D60	Diesel	5480	6	98.43	4	TD 122 FL	Diesel	11980	6	130.17	47
D6A180	Diesel	5480	6	98.43	7	TD 122 FR	Diesel	11980	6	130.17	47
D6A210	Diesel	5480	6	98.43	7	TD 122 FS	Diesel	11980	6	130.17	47
D70CHC	Diesel	6725	6	104.78	17	TD 122 KHD	Diesel	11980	6	130.17	48
D7A285	Diesel	6700	6	104.78	15	TD 123 E	Diesel	11980	6	130.17	47
D7B230	Diesel	6700	6	104.78	15	TD 123 ES	Diesel	11980	6	130.17	47
D7B260	Diesel	6700	6	104.78	15	TD 50 A	Diesel	5100	6	95.25	2
D7C215	Diesel	7300	6	107.00	21	TD 50 B	Diesel	5100	6	95.25	2
D7C250	Diesel	7300	6	107.00	21	TD 60 A	Diesel	5480	6	98.43	8
D7C290	Diesel	7300	6	107.00	21	TD 60 B	Diesel	5480	6	98.43	5
D7C310	Diesel	7300	6	107.00	21	TD 60 C	Diesel	5480	6	98.43	5
HD 100 A	Diesel	9600	6	120.64	27	TD 61 B	Diesel	5480	6	98.43	6
HD 100 D	Diesel	9600	6	120.64	27	TD 61 F	Diesel	5480	6	98.43	6
MD 100A	Diesel	9600	6	120.64	23	TD 61 FB	Diesel	5480	6	98.43	6
MD 100B	Diesel	9600	6	120.64	23	TD 61 G	Diesel	5480	6	98.43	6
MD 120A	Diesel	11977	6	130.17	40	TD 61 GA	Diesel	5480	6	98.43	6
TAMD 120 A	Diesel	11977	6	130.17	42	TD 61 GB	Diesel	5480	6	98.43	6
TAMD 120 B	Diesel	11977	6	130.17	41	TD 61 GC	Diesel	5480	6	98.43	6
TD 100 A	Diesel	9600	6	120.64	23	TD 61 GE	Diesel	5480	6	98.43	6
TD 100 AHC	Diesel	9600	6	120.64	23	TD 61 GS	Diesel	5480	6	98.43	6
TD 100 ARC	Diesel	9600	6	120.64	23	TD 63 E	Diesel	5480	6	98.43	9
TD 100 B	Diesel	9600	6	120.64	23	TD 63 ES	Diesel	5480	6	98.43	9
TD 100 G	Diesel	9600	6	120.64	34	TD 70 A	Diesel	6700	6	104.78	10
TD 100 GA	Diesel	9600	6	120.64	34	TD 70 B	Diesel	6700	6	104.78	10
TD 100 GB	Diesel	9600	6	120.64	36	TD 70 C	Diesel	6700	6	104.78	11
TD 100 GG	Diesel	9600	6	120.64	24	TD 70 CHC	Diesel	6725	6	104.78	17
TD 101 F	Diesel	9600	6	120.64	35	TD 70 D	Diesel	6700	6	104.78	11
TD 101 FA	Diesel	9600	6	120.64	35	TD 70 E	Diesel	6700	6	104.78	10
TD 101 FC	Diesel	9600	6	120.64	35	TD 70 F	Diesel	6700	6	104.78	12
TD 101 FD	Diesel	9600	6	120.64	35	TD 70 FS	Diesel	6700	6	104.78	12
TD 101 G	Diesel	9600	6	120.64	35	TD 70 G	Diesel	6700	6	104.78	12
TD 101 GA	Diesel	9600	6	120.64	35	TD 70 H	Diesel	6700	6	104.78	10
TD 101 GB	Diesel	9600	6	120.64	32	TD 70 HA	Diesel	6700	6	104.78	10
TD 101 GE	Diesel	9600	6	120.64	32	TD 71 E	Diesel	6725	6	104.78	18
TD 102 F	Diesel	9600	6	120.64	33	TD 71 F	Diesel	6700	6	104.78	13
TD 102 FBQ	Diesel	9600	6	120.64	37	TD 71 FA	Diesel	6730	6	104.78	20
TD 102 FD	Diesel	9600	6	120.85	33	TD 71 FC	Diesel	6730	6	104.78	20
TD 102 FDQ	Diesel	9600	6	120.64	33	TD 71 FD	Diesel	6730	6	104.78	19
TD 102 FEQ	Diesel	9600	6	120.64	33	TD 71 FO	Diesel	6700	6	104.78	14
TD 102 FF	Diesel	9600	6	120.64	33	TD 71 FS	Diesel	6730	6	104.78	20
TD 102 FH	Diesel	9600	6	120.64	33	TD 71 FSQ	Diesel	6730	6	104.78	19
TD 102 FL	Diesel	9600	6	120.64	33	TD 71 G	Diesel	6725	6	104.78	18
TD 102 FM	Diesel	9600	6	120.64	33	TD 73 E	Diesel	6700	6	104.78	16
TD 102 FS	Diesel	9600	6	120.64	39	TD 73 ES	Diesel	6700	6	104.78	16
TD 102 FT	Diesel	9595	6	120.64	22	THD 100 A	Diesel	9600	6	120.64	29
TD 103 E	Diesel	9600	6	120.64	37	THD 100 D	Diesel	9600	6	120.64	30
TD 103 EA	Diesel	9600	6	120.64	39	THD 100 DA	Diesel	9600	6	120.64	29
TD 103 ES	Diesel	9600	6	120.64	38	THD 100 DB	Diesel	9600	6	120.64	29

		CC			9			CC			9
THD 100 DC	Diesel	9600	6	120.64	30						
THD 100 DD	Diesel	9600	6	120.64	30						
THD 100 E	Diesel	9600	6	120.64	28						
THD 100 EA	Diesel	9600	6	120.64	28						
THD 100 EB	Diesel	9600	6	120.64	28						
THD 100 EC	Diesel	9600	6	120.64	28						
THD 100 ED	Diesel	9600	6	120.64	28						
THD 100 EE	Diesel	9600	6	120.64	28						
THD 100 EK	Diesel	9600	6	120.64	28						
THD 101 GB	Diesel	9600	6	120.64	28						
THD 101 GC	Diesel	9600	6	120.64	28						
THD 101 GD	Diesel	9600	6	120.64	31						
THD 101 KB	Diesel	9600	6	120.64	31						
THD 101 KC	Diesel	9600	6	120.64	31						
THD 101 KE	Diesel	9600	6	120.64	31						
THD 101 KF	Diesel	9600	6	120.64	25						
THD 102 KA	Diesel	9600	6	120.64	25						
THD 102 KB	Diesel	9600	6	120.64	31						
THD 102 KD	Diesel	9600	6	120.64	31						
THD 102 KE	Diesel	9600	6	120.64	25						
THD 102 KF	Diesel	9600	6	120.64	31						
THD 103 KB	Diesel	9600	6	120.64	25						
THD 103 KD	Diesel	9600	6	120.64	25						
THD 103 KF	Diesel	9600	6	120.64	25						
TID 120 F	Diesel	11977	6	130.17	42						
TMD 100 A	Diesel	9600	6	120.64	23						
TMD 120 A	Diesel	11977	6	130.17	42						



21

9



21

9

860S	01/74→	4	FL 6 FL 611	12/94→03/00	7
861	01/74→	4	FL 6 FL 611	12/94→03/00	9
3200	01/74→	4	FL 6 FL 612	09/85→12/99	6
3300	01/74→	4	FL 6 FL 612	09/85→12/99	7
5350B		6	FL 6 FL 612	09/85→12/99	9
5350B	01/85→	18	FL 6 FL 612	11/91→12/99	7
A20		6	FL 6 FL 612	11/91→12/99	9
A20	01/85→	18	FL 6 FL 614	09/85→03/00	6
A25		6	FL 6 FL 614	09/85→03/00	7
A25	01/85→	18	FL 6 FL 614	09/85→03/00	9
B 6 B6R, B6LE	11/91→	7	FL 6 FL 615	11/91→03/00	7
B 6 B6R, B6LE	11/91→	9	FL 6 FL 615	11/91→03/00	9
B 10 B10M		28	FL 6 FL 618	11/91→03/00	7
B 10 B10M		29	FL 6 FL 618	11/91→03/00	9
B 10 B10M		30	FL 7 FL 7/230	09/85→09/98	13
B 12 B 12	01/92→	47	FL 7 FL 7/230	09/85→09/98	14
B 12 B 12	01/92→	50	FL 7 FL 7/230	09/85→09/98	15
B 12 B 12	02/06→	50	FL 7 FL 7/230	09/85→09/98	16
B9M	01/86→	25	FL 7 FL 7/260	11/91→09/98	15
B9M ch 20001-		25	FL 7 FL 7/260	11/91→09/98	16
B10M	01/86→	25	FL 7 FL 7/290	10/93→09/98	15
B10M ch 20001-		25	FL 10 FL 10/280	09/85→12/90	35
B57	01/85→	18	FL 10 FL 10/320	12/95→09/98	39
C10M	01/86→	25	FL 10 FL 10/360	12/95→09/98	39
DR860 T	01/74→	4	FL 10 FL 10H/320	12/95→09/98	39
DR860 TL	01/74→	4	FL 10 FL 10H/360	12/95→09/98	39
F 6 F 609	03/75→02/80	3	FL 12 FL 12/380	09/95→09/98	51
F 6 F 610	02/80→10/86	5	FL 12 FL 12/420	09/95→09/98	50
F 6 F 611	09/75→01/80	3	FL 12 FL 12H/380	09/95→09/98	51
F 6 F 611	02/80→02/86	5	FL 12 FL 12H/420	09/95→09/98	50
F 6 F 612	04/83→02/86	5	FL7	01/85→	18
F 6 F 613, F 614	09/75→02/86	5	FL88	01/65→	23
F 6 F 613, F 614	09/75→02/86	8	FL608-614	01/86→	6
F 6 F 615 S	12/78→10/81	5	FM 7 FM 7/250	08/98→12/01	21
F 6 F 616	02/81→02/86	5	FM 7 FM 7/290	08/98→12/01	21
F 6 F 617 S	12/78→02/86	5	FM 12 FM 12/340	08/98→09/05	50
F 7 F 7	08/78→12/85	12	FM 12 FM 12/380	08/98→09/05	50
F 10 F 10/260	02/82→06/85	34	FM 12 FM 12/420	08/98→09/05	50
F 10 F 10/260	02/82→06/85	35	FM 12 FM 12/460	08/98→09/05	50
F 10 F 10/280	08/77→02/82	23	FM 12 FM 12H/340	08/98→09/05	50
F 10 F 10/300	10/83→12/87	35	FM 12 FM 12H/380	08/98→09/05	50
F 10 F 10/320	10/87→12/94	33	FM 12 FM 12H/420	08/98→09/05	50
F 10 F 10/320	10/87→12/94	37	FS 7 FS 718	09/94→03/96	15
F 10 F 10/320	10/87→12/94	38	G88	01/65→	23
F 12 F 12/320	01/87→12/87	46	Industrial		17
F 12 F 12/320, F 12/330	08/77→12/86	45	Industrial		23
F 12 F 12/320, F 12/330	08/77→12/86	46	Industrial		24
F 12 F 12/360	01/88→12/94	47	Industrial		40
F 12 F 12/370	08/77→12/87	45	Industrial		41
F 12 F 12/400	01/88→12/94	47	Industrial		42
F 12 F 12/400, F 12/410	01/88→12/94	47	Industrial	01/70→12/81	42
F 80 F 88/260	08/65→06/77	23	LM840	01/74→	4
F 80 F 89	10/70→06/77	49	LM841	01/74→	4
F 80 F 89/330	10/70→06/77	49	LM845	01/74→	4
F10	01/74→12/81	36	LM846	01/74→	4
F88	01/65→	23	LM1254		23
F88	01/74→12/81	36	LM1254	01/65→	23
F607-614	01/74→	4	LM1640		23
FH 12 FH 12/340	08/93→	50	LM1640	01/65→	23
FH 12 FH 12/380	08/93→	50	LM1641		23
FH 12 FH 12/380	08/93→	51	LM1641	01/65→	23
FH 12 FH 12/420	08/93→	50	N 10 N 10/270	01/73→12/89	34
FH 12 FH 12/460	08/98→	50	N 10 N 10/270	01/73→12/89	35
FH 12 FH 12-500	09/01→	50	N 10 N 10/300	01/73→12/89	23
FL 6 FL 608	10/85→12/99	6	N 10 N 10/300	01/73→12/89	35
FL 6 FL 608	01/91→12/99	7	N10	01/74→12/81	36
FL 6 FL 608	01/91→12/99	9	N88	01/65→	23
FL 6 FL 608	01/93→12/99	7	NH 12 NH 12/380	05/99→	50
FL 6 FL 608	01/93→12/99	9	NH 12 NH 12/420	05/99→	50
FL 6 FL 610	09/85→11/94	6	Parca 654		23
FL 6 FL 611	09/85→11/94	6	Parca 654	01/65→	23
FL 6 FL 611	09/85→03/00	6	TC860TL	01/74→	4
FL 6 FL 611	09/85→03/00	7	VHK510		23
FL 6 FL 611	09/85→03/00	9	VHK510	01/65→	23

VOLVO COMMERCIAL



cc



kW/PS

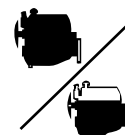

1	D 50 A	5100	6	95.25		79/107	BK210 (Steel), 1,25mm (x2)	DK210	EE210 [7]
	D 50 B	5100	6	95.25		86/117			
2	TD 50 A	5100	6	95.25	Turbo	108/147	BK210 (Steel), 1,25mm (x2)	DK210	EE210 [7]
	TD 50 B	5100	6	95.25	Turbo	121/165			
3	D 60	5480	6	98.43		88/120	BK210 (Steel), 1,25mm (x2) Eng.47364→	DK210	EE210 [7]
4	D60	5480	6	98.43		88.5/120	BK210 (Steel), 1,25mm (x2)	DK211	EE210 [7]
5	TD 60 C	5480	6	98.43	Turbo	108-113/ 147-154	BK210 (Steel), 1,25mm (x2)	DK211	EE211
	TD 60 B	5480	6	98.43	Turbo	128-132/ 174-180			
6	TD 61 G	5480	6	98.43	Turbo Intercooled	108-152/ 147-207	BT830 (Steel) (x2)	DT830 ○	ET830 GT830 ○
	TD 61 GA	5480	6	98.43	Turbo	112/152			
	TD 61 GE	5480	6	98.43	Turbo	130/177			
	TD 61 GB/TD 61 GS	5480	6	98.43	Turbo	131-132/ 179-180			
	TD 61 B/TD 61 GC	5480	6	98.43	Turbo	132/180			
	TD 61 F	5480	6	98.43	Turbo Intercooled	150-152/ 204-207			
TD 61 FB	5480	6	98.43	Turbo Intercooled	153/208				
7	D6A180	5480	6	98.43	Euro 3/Turbo Intercooled	132/180	BT830 (Steel) (x2)		ET830
	D6A210	5480	6	98.43	Euro 3/Turbo Intercooled	154/210			
8	TD 60 A	5480	6	98.43	Turbo	132/180	BK210 (Steel), 1,25mm (x2)	DK210	EE210 [7]
9	TD 63 E	5480	6	98.43	Turbo Intercooled	132/180	BT830 (Steel) (x2)	DT830 ○	ET830 GT830 ○
	TD 63 ES	5480	6	98.43	Turbo Intercooled	154/210			
10	D 70 A	6700	6	104.78		106/144	BE220 (Steel) (x2)	DE220	EE220 GE220
	D 70 B	6700	6	104.78		110/150			
	TD 70 A	6700	6	104.78	Turbo	136/185			
	TD 70 HA	6700	6	104.78	Turbo	143/195			
	TD 70 B	6700	6	104.78	Turbo	152/207			
	TD 70 E	6700	6	104.78	Turbo	154/210			
	TD 70 H	6700	6	104.78	Turbo	157/214			
11	TD 70 D	6700	6	104.78	Turbo	121/165	BE220 (Steel) (x2)	DE220	
	TD 70 C	6700	6	104.78	Turbo	149-152/ 202-207			
12	TD 70 G	6700	6	104.78	Turbo	147-156/ 200-212	BE220 (Steel) (x2)	DE220	EE221 GE221
	TD 70 F	6700	6	104.78	Turbo	162-174/ 220-237			
	TD 70 FS	6700	6	104.78	Turbo	180/245			
13	TD 71 F	6700	6	104.78	Turbo	169-180/ 220-245	BT840 (Steel) (x2)	DT840	ET840 GT840
14	TD 71 FQ	6700	6	104.78	Turbo Intercooled	169-173/ 220-235	BT840 (Steel) (x2)	DT840	ET840 GT840
15	D7B230	6700	6	104.78	Euro 2/Turbo Intercooled	169/230	BT840 (Steel) (x2)	DT840	ET841 GT841
	D 7 B260/D7B260	6700	6	104.78	Euro 2/Turbo Intercooled	191/260			
	D7A285	6700	6	104.78	Euro 2/Turbo Intercooled	210/286			
16	TD 73 E	6700	6	104.78	Turbo Intercooled	169/230	BT840 (Steel) (x2)	DT840	ET841 GT841
	TD 73 ES	6700	6	104.78	Turbo Intercooled	191/260			
17	D70CHC	6725	6	104.78			BE220 (Steel) (x2)	DE220	EE220 GE220
	TD 70 CHC	6725	6	104.78	Turbo				
18	TD 71 E/TD 71 G	6725	6	104.78	Turbo Intercooled	180/245	BT840 (Steel) (x2)	DT840	ET840 GT840
19	TD 71 FSQ	6730	6	104.78	Turbo Intercooled	169-184/ 230-250	BT840 (Steel) (x2)	DT840	ET840 GT840
	TD 71 FD	6730	6	104.78	Turbo Intercooled	180/245			

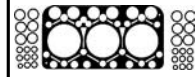
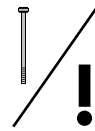
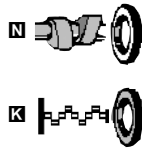
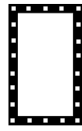
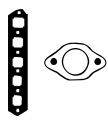

BE220



BK210

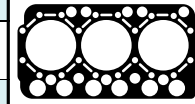

BT830, BT840



JJ135



JJ141

		JJ135			HT022 (x6)[14] S
					HT022 (x6)[14] S
		JJ135			HT010 (x6)[14] S
		JJ135			
		JJ135			HT010 (x6)[14] S
		JJ135			HBS427[8] \otimes M11x1.5x140mm (x20) HT009 (x6)[14] S
					HBS427[8] \otimes M11x1.5x140mm (x20)
		JJ135			HT010 (x6)[14] S
					HHBS427[8] \otimes M11x1.5x140mm (x20) HT009 (x6)[14] S
HA337 S		JJ141			HT008 (x6)[14] S
HA337 S		JJ141			HT008 (x6)[14] S
HA337 S		JJ141			HT008 (x6)[14] S
		JJ141			HT007 (x6)[14] S
		JJ141			
		JJ141			
		JJ474			HT007 (x6)[14] S
		JJ141			
		JJ141			HT007 (x6)[14] S
		JJ141			HT007 (x6)[14] S

VOLVO COMMERCIAL









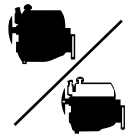



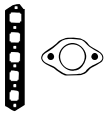



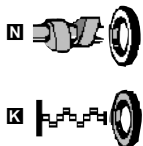
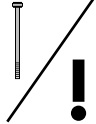
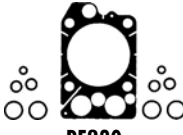
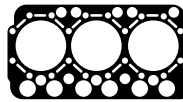
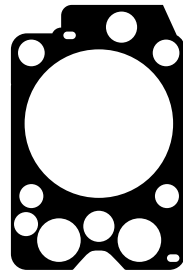

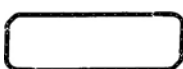

cc



kW/PS



20	TD 71 FA/TD 71 FC TD 71 FS	6730 6730	6 6	104.78 104.78	Turbo Turbo Intercooled	173/235 178-184/ 242-250	BT840 (Steel) (x2)	DT840	ET840 GT840
21	D7C215 D7C250 D7C290 D7C310	7300 7300 7300 7300	6 6 6 6	107.00 107.00 107.00 107.00	Euro 2/Turbo Intercooled Euro 2/Turbo Intercooled Euro 2/Turbo Intercooled Euro 2/Turbo Intercooled	158/215 184/250 213/290 228/310	BT840 (Steel) (x2)		
22	TD 102 FT	9595	6	120.64	Turbo Intercooled	228/310	BT930 (Steel) (x6)	DT930 ○	ET930
23	D100BHC/D100BRC/MD 100A/ MD 100B TD 100 AHC/TD 100 ARC/ TMD 100 A D100B D 100 B TD 100 A TD 100 B	9600 9600 9600 9600 9600 9600	6 6 6 6 6 6	120.64 120.64 120.64 120.64 120.64 120.64	Turbo Turbo Turbo Turbo Turbo Turbo	122/166 147/200 176-190/ 239-258 206-220/ 280-299	BE230 (Steel) (x6)	DE230	EE230 GE230 [7]
24	TD 100 GG	9600	6	120.64	Turbo		BT930 (Steel) (x6)	DT930 ○	ET930 GT930 ○
25	THD 102 KE THD 103 KF THD 102 KA THD 103 KB THD 101 KF THD 103 KD	9600 9600 9600 9600 9600 9600	6 6 6 6 6 6	120.64 120.64 120.64 120.64 120.64 120.64	Turbo Intercooled Turbo Turbo Intercooled Turbo Turbo Turbo	180/245 210/286 210/286 228/310 250/340	BT930 (Steel) (x6)		
26	D 100 A	9600	6	120.64		122-147/ 166-200	BE230 (Steel) (x6)	DE230	EE230
27	HD 100 A HD 100 D	9600 9600	6 6	120.64 120.64		129/175 132/180			
28	THD 100 EA THD 100 E THD 100 EB/THD 100 EC THD 100 ED THD 101 GB THD 100 EK THD 101 GC THD 100 EE	9600 9600 9600 9600 9600 9600 9600 9600	6 6 6 6 6 6 6 6	120.64 120.64 120.64 120.64 120.64 120.64 120.64 120.64	Turbo Turbo Intercooled Turbo Turbo Intercooled Turbo Turbo Turbo Turbo	133-180/ 180-245 160-203/ 218-276 160-203/ 218-276 160-203/ 218-276 160/218 179/243 180/245 212/288	BT930 (Steel) (x6)		EA230 Eng.2499 →
29	THD 100 DA THD 100 A THD 100 DB	9600 9600 9600	6 6 6	120.64 120.64 120.64	Turbo Intercooled Turbo Turbo Intercooled	133/181 139-191/ 200-260 160-203/ 218-276	BE230 (Steel) (x6)	DE230	
30	THD 100 D THD 100 DC THD 100 DD	9600 9600 9600	6 6 6	120.64 120.64 120.64	Turbo Turbo Intercooled Turbo	155-177/ 211-241 160-203/ 218-276 203/276	BE230 (Steel) (x6)	DE230	EA230 Eng.2499 →

						 BE230  BT840  BT930  JN336  JJ141  JJ476
		JJ141				
	JN336 (x6)				HT005 (x6)[14] 	
					HT006 (x6)[14] 	
		JJ476			HT005 (x6)[14] 	
					HT006 (x6)[14] 	
					HT005 (x6)[14] 	
					HT006 (x6)[14] 	
					HT005 (x6)[14] 	
					HT006 (x6)[14] 	
					HT005 (x6)[14] 	
	JN336 (x6)				HT006 (x6)[14] 	
					HT005 (x6)[14] 	
					HT006 (x6)[14] 	

VOLVO COMMERCIAL



cc



kW/PS

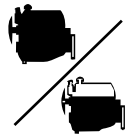

31	THD 101 GD	9600	6	120.64	Turbo	160-203/ 218-276	BT930 (Steel) (x6)		
	THD 102 KF	9600	6	120.64	Turbo Intercooled	180-210/ 250-286			
	THD 101 KB	9600	6	120.64	Turbo Intercooled	210/286			
	THD 102 KB	9600	6	120.64	Euro 1/Turbo Intercooled/ Straight	210/286			
	THD 101 KC	9600	6	120.64	Turbo Intercooled	228/310			
	THD 101 KE	9600	6	120.64	Bi-Turbo Intercooled	235/320			
	THD 102 KD	9600	6	120.64	Turbo Intercooled	252/343			
32	TD 101 GB	9600	6	120.64	Turbo Intercooled	185-200/ 252-272	BT930 (Steel) (x6)	DT930 ○	ET930 GT930 ○
	TD 101 GE	9600	6	120.64	Turbo Intercooled	200/272			
33	TD 102 FEQ	9600	6	120.64	Turbo Intercooled	191/260	BT930 (Steel) (x6)	DT930 ○	ET930 ET931 [48] GT930 ○
	TD 102 FH	9600	6	120.64	Turbo Intercooled	210-234/ 286-318			
	TD 102 F/TD 102 FF	9600	6	120.64	Turbo Intercooled	230-234/ 313-318			
	TD 102 FM	9600	6	120.64	Turbo Intercooled	230-252/ 313-343			
	TD 102 FDQ	9600	6	120.64	Turbo Intercooled	232-234/ 316-318			
	TD 102 FL	9600	6	120.64	Euro 1/Turbo	234/318			
	TD 102 FD	9600	6	120.85	Euro 1/Turbo Intercooled	234/318			
34	TD 100 G	9600	6	120.64	Turbo	192-202/ 261-275	BT930 (Steel) (x6)	DT930 ○	EE230 GT930 ○
	TD 100 GA	9600	6	120.64	Turbo	200/272			
35	TD 101 G	9600	6	120.64	Turbo	192-202/ 261-275	BT930 (Steel) (x6)	DT930 ○	ET930 ET931 [48] GT930 ○
	TD 101 GA	9600	6	120.64	Turbo Intercooled	200/272			
	TD 101 F	9600	6	120.64	Turbo Intercooled	215-220/ 292-299			
	TD 101 FA	9600	6	120.64	Turbo Intercooled	220/299			
	TD 101 FD	9600	6	120.64	Turbo Intercooled	220-222/ 299-302			
	TD 101 FC	9600	6	120.64	Turbo Intercooled	221/301			
36	TD 100 GB	9600	6	120.64	Turbo	207/220/ 280/300	BT930 (Steel) (x6)		EE230
37	TD 103 E	9600	6	120.64	Turbo Intercooled	210-235/ 286-320	BT930 (Steel) (x6)	DT930 ○	ET930 ET931 [48]
	TD 102 FBQ	9600	6	120.64	Turbo Intercooled	228/310			
38	TD 103 ES	9600	6	120.64	Euro 1/Turbo Intercooled	210-235/ 286-320	BT930 (Steel) (x6)	DT930 ○	ET930 ET931 [48]
39	D10A320	9600	6	120.64		235/320	BT930 (Steel) (x6)	DT930 ○	ET930
	TD 103 EA	9600	6	120.64	Euro 1/Turbo Intercooled	235/320			
	TD 102 FS	9600	6	120.64	Turbo Intercooled	250/340			
	D10A360	9600	6	120.64		265/360			
40	MD 120A	11977	6	130.17			BE240 (Steel) (x6)		
41	TAMD 120 B	11977	6	130.17	Turbo		BE240 (Steel) (x6)		
42	TD 120 GG/TID 120 F	11977	6	130.17	Turbo		BE240 (Steel) (x6)	DE240 ○	EE240 GE240 ○ [7]
	TAMD 120 A	11977	6	130.17	Turbo	225/243/ 306/330			
	TMD 120 A	11977	6	130.17		225/243/ 306/330			

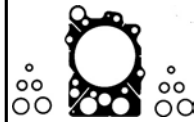
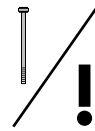
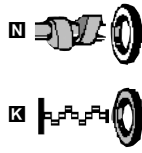
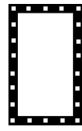
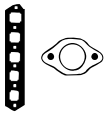



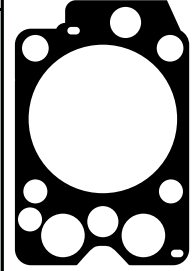













BE240



BT930



JJ476

					HT005 (x6)[14]  HT006 (x6)[14] 
					HT005 (x6)[14]  HT006 (x6)[14] 
		JJ473 [48] JJ476			HT005 (x6)[14] 
					HT005 (x6)[14]  HT006 (x6)[14] 
		JJ473 [48] JJ476			HT005 (x6)[14]  HT006 (x6)[14] 
					HT005 (x6)[14]  HT006 (x6)[14] 
					HT005 (x6)[14] 
		JJ473 [48] JJ476			HT005 (x6)[14] 
					HT005 (x6)[14] 
					HT004 (x6)[14]  HT004 (x6)[14] 

VOLVO COMMERCIAL









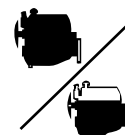

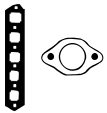

cc

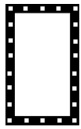

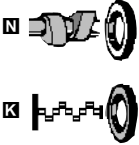
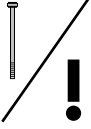
kW/PS

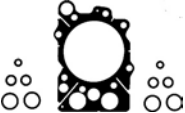
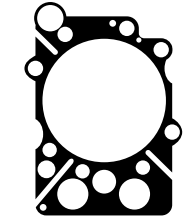









43	TD 121 FA	11980	6	130.17	Turbo Intercooled	206/280			
	TD 121 FB	11980	6	130.17	Turbo Intercooled	210/286			
	TD 121 FC	11980	6	130.17	Turbo Intercooled	232/315			
	TD 121 FE	11980	6	130.17	Turbo Intercooled	257/350			
	TD 121 FF	11980	6	130.17	Turbo Intercooled	272/370			
44	TD 120 FA	11980	6	130.17	Turbo Intercooled	213/290	BE240 (Steel) (x6)	DE240 ○	EE240
	TD 120 FB	11980	6	130.17	Turbo Intercooled	226-265/ 307-360			
45	TD 120 E	11980	6	130.17	Turbo	225-273/ 306-371	BE240 (Steel) (x6)	DE240 ○	EE240 GE240 ○ [7]
	TD 120 G	11980	6	130.17	Turbo	226-243/ 307-330			
	TD 120 GA	11980	6	130.17	Turbo	227/308			
	TD 120 F/TD 120 FC	11980	6	130.17	Turbo Intercooled	265/360			
	TD 121 F	11980	6	130.17	Turbo Intercooled	272-283/ 370-385			
	TD 120 D	11980	6	130.17	Turbo	273/371			
	TD 121 FD	11980	6	130.17	Turbo Intercooled	283/385			
46	TD 121 G	11980	6	130.17	Turbo	235-243/ 320-330	BE240 (Steel) (x6)	DE240 ○	EE240 GE240 ○ [7]
	TD 121 GD	11980	6	130.17	Turbo	243/330			
	TD 121 FK	11980	6	130.17	Turbo Intercooled	280/381			
47	TD 122 F	11980	6	130.17	Turbo	257-262/ 350-356	BT850 (Steel) (x6)	DT850 ○	ET850 GT850 ○ GT851 ○ [48]
	TD 122 FH	11980	6	130.17	Euro 1/Turbo Intercooled	262/356			
	TD 122 FR	11980	6	130.17	Turbo Intercooled	262-291/ 356-396			
	TD 123 E	11980	6	130.17	Euro 1/Turbo	262-265/ 356-360			
	TD 122 FA	11980	6	130.17	Turbo	272/370			
	TD 122 FK	11980	6	130.17	Turbo Intercooled	287-291/ 390-396			
	TD 122 FS	11980	6	130.17	Turbo Intercooled	287-291/ 395-396			
	TD 122 FL	11980	6	130.17	Turbo Intercooled	291/396			
	TD 123 ES	11980	6	130.17	Euro 1/Turbo	298/405			
48	TD 122 KHD	11980	6	130.17	Turbo Intercooled/Straight	272/370			
49	TD 120 A	12000	6	130.17	Turbo	243/330	BE240 (Steel) (x6)	DE240 ○	EE240 GE240 ○ [7]
	TD 120 C	12000	6	130.17	Turbo	260/354			
50	D12A340	12100	6	131.00	Turbo Intercooled	250/340	AF5280 (SE)		
	D12C340	12100	6	131.00	Euro 2/Turbo Intercooled	250/340			
	D12D340	12100	6	131.00	Euro 3/Turbo Intercooled	250/340			
	D12C380	12100	6	131.00	Turbo Intercooled	279/379			
	D12D380	12100	6	131.00	Euro 3/Turbo Intercooled	279/379			
	D12A420	12100	6	131.00	Euro 2/Turbo Intercooled	309/420			
	D12C420	12100	6	131.00	Turbo Intercooled	309/420			
	D12D420	12100	6	131.00	Euro 3/Turbo Intercooled	309/420			
	D12C460	12100	6	131.00	Turbo Intercooled	338/460			
	D12D460	12100	6	131.00	Euro 3/Turbo Intercooled	338/460			
	D12D500	12100	6	131.00	Euro 3/Turbo Intercooled	368/500			
51	D12A380	12110	6	131.00	Euro 2/Turbo Intercooled	279/380	AF5280 (SE)		

						 <p>AF5280</p>  <p>BE240</p>  <p>BT850</p>  <p>JM5270</p>  <p>JJ468</p>  <p>JJ475</p>
		JJ475				
		JJ475			HBS482 [8] ☉ M14x2x189mm (x8) HT004 (x6)[14] ☒	
		JJ475			HBS482 [8] ☉ M14x2x189mm (x8) HT003 (x6)[14] ☒ HT004 (x6)[14] ☒	
		JJ475			HBS482 [8] ☉ M14x2x189mm (x8) HT003 (x6)[14] ☒	
		JJ468 [48] JJ475			HBS482 (x6)[8] ☉ M14x2x189mm (x8) HT002 (x6)[14] ☒	
	JM5270 (Rubber)					
		JJ475			HBS482 [8] ☉ M14x2x189mm (x8) HT003 (x6)[14] ☒ HT004 (x6)[14] ☒	
					HT002 (x6)[14] ☒	
					HT002 (x6)[14] ☒	

NUMERICAL PARTS LIST





Numerische Teilenummernliste • Liste des références produits
Elenco numerico articoli • Lista de referencias





 AA5010 IVECO 66	 AN010 FIAT COMMERCIAL 28	 BF980 RENAULT TRUCKS / RVI 258	 BR710 HINO 50
AA5150 FORD COMMERCIAL 42	NEW HOLLAND 212	BF990 RENAULT TRUCKS / RVI 258	BS040 MITSUBISHI 204
NEW HOLLAND 214	OM 218	BG070 MAN 112, 114	BS310 MERCEDES-BENZ 150, 152
AB5100 RENAULT TRUCKS / RVI 258	AN340 FIAT COMMERCIAL 30	BG180 RENAULT TRUCKS / RVI 266	BS340 FIAT COMMERCIAL 28, 30
AB5110 RENAULT TRUCKS / RVI 258	NEW HOLLAND 214	BG650 MAN 112, 114, 116, 120, 122, 124	IVECO 62
AC5841 MERCEDES-BENZ 168, 170	OM 218	BG660 SCANIA 274, 276, 278	NEW HOLLAND 212
AC5931 MERCEDES-BENZ 154, 156	AN360 FIAT COMMERCIAL 32	BG850 MAN 114, 118, 120, 122, 124	BS350 IVECO 66, 68
AD490 FORD COMMERCIAL 42	IVECO 70	MERCEDES-BENZ 174, 176, 178, 180, 186, 188, 192, 194, 196, 198, 202	NEW HOLLAND 214
AD510 FORD COMMERCIAL 40	AN460 FIAT COMMERCIAL 28	BG990 MERCEDES-BENZ 148	BS560 SCANIA 274, 276, 278
AD5700 DAF 10	NEW HOLLAND 212	BH790 FIAT COMMERCIAL 32, 36	BS640 MITSUBISHI 204
AD5750 DAF 10	OM 218	IVECO 72, 76	BS930 MITSUBISHI 204
AD5770 RENAULT TRUCKS / RVI 266	AN470 FIAT COMMERCIAL 28	NEW HOLLAND 214	BS980 FORD COMMERCIAL 40
AE200 FORD COMMERCIAL 40	IVECO 62	BH840 RENAULT TRUCKS / RVI 260, 262	BS990 FORD COMMERCIAL 40, 42
AE5700 NISSAN 216	NEW HOLLAND 212	BJ040 FORD COMMERCIAL 40	BT570 SCANIA 272, 274
AE5710 NISSAN 216	AN480 NEW HOLLAND 212	BJ050 FORD COMMERCIAL 40	BT830 VOLVO COMMERCIAL 286
AE5940 NISSAN 216	AS410 MERCEDES-BENZ 158, 160, 162, 164, 166, 168	BJ060 FORD COMMERCIAL 40	BT840 VOLVO COMMERCIAL 286, 288
AF5280 VOLVO COMMERCIAL 292	AS450 MERCEDES-BENZ 176, 180	BJ260 ISUZU 52	BT850 VOLVO COMMERCIAL 292
AF5370 MERCEDES-BENZ 184, 186, 188, 190, 192	AX050 DAF 10	BJ390 NISSAN 216	BT930 VOLVO COMMERCIAL 288, 290
AG450 SCANIA 272	AX070 NEW HOLLAND 212	BJ970 HINO 50	BV270 SCANIA 278, 280
AG7340 MWM 206	AX700 FIAT COMMERCIAL 32	BJ980 HINO 50	BV500 MAN 102, 104, 106, 108, 110, 112
AG8280 MERCEDES-BENZ 182, 200	IVECO 70	BK040 ISUZU 52	BV520 FIAT COMMERCIAL 28, 30
AG9350 IVECO 70	AX850 NEW HOLLAND 212	BK210 VOLVO COMMERCIAL 286	IVECO 62
AG9360 IVECO 72	AY020 DEUTZ / KHD 20	BK490 FIAT COMMERCIAL 32, 36	NEW HOLLAND 212
AG9370 DEUTZ / KHD 18	FIAT COMMERCIAL 30, 32	IVECO 76	BV530 RENAULT TRUCKS / RVI 266
AG9380 DEUTZ / KHD 18	IVECO 66	BK530 NISSAN 216	BV590 HINO 50
AG9390 DEUTZ / KHD 18	NEW HOLLAND 212, 214	BK560 MITSUBISHI 204	BV710 FIAT COMMERCIAL 28, 30
AG9400 DEUTZ / KHD 18	OM 218	BK890 MITSUBISHI 204	IVECO 62, 64, 66
AG9410 DEUTZ / KHD 18	AY190 CUMMINS 4	BK960 HINO 50	NEW HOLLAND 212, 214
AG9420 DEUTZ / KHD 18	AY370 FIAT COMMERCIAL 32	BL150 BEDFORD 2	BW050 RENAULT TRUCKS / RVI 266
AH870 BEDFORD 2	IVECO 68, 70	BL160 BEDFORD 2	BW120 IVECO 66
AH940 BEDFORD 2	AY580 RENAULT TRUCKS / RVI 258	BL540 MAN 112	BW151 FIAT COMMERCIAL 34, 36
AH5370 DAF 14	AY590 RENAULT TRUCKS / RVI 258	BL600 RENAULT TRUCKS / RVI 260	IVECO 72, 74, 76
AH5390 MERCEDES-BENZ 176	AY650 FIAT COMMERCIAL 28	BL710 DAF 10, 12	BW160 FIAT COMMERCIAL 28, 30
AH5420 MWM 206	NEW HOLLAND 212	BL780 FORD COMMERCIAL 40	IVECO 62, 64, 66
AH5440 MAN 104	AY680 RENAULT TRUCKS / RVI 258	BL991 FIAT COMMERCIAL 34	NEW HOLLAND 212
AH5450 MAN 114, 118, 120, 122, 124	AY690 RENAULT TRUCKS / RVI 258	IVECO 74, 76	BW370 MERCEDES-BENZ 148
MERCEDES-BENZ 174, 176, 178, 180, 186, 188, 192, 194, 196, 198, 202	AY700 RENAULT TRUCKS / RVI 258	NEW HOLLAND 214	BW380 MERCEDES-BENZ 148, 150
AH5460 MWM 206	AZ020 SCANIA 274, 276, 278	BM780 DEUTZ / KHD 18, 20	BW390 RENAULT TRUCKS / RVI 262, 264, 266
AH5490 MWM 206	BC550 IVECO 70	IVECO 62, 66	BW470 DAF 12, 14
AH5570 DEUTZ / KHD 18	BC790 MERCEDES-BENZ 148	BN110 BEDFORD 2	BW480 DAF 10
AH5580 DEUTZ / KHD 18	BC800 MERCEDES-BENZ 150	BN290 RENAULT TRUCKS / RVI 260	BW530 CUMMINS 4
AH5590 DEUTZ / KHD 18	BD600 FORD COMMERCIAL 42	IVECO 62, 66	BW920 RENAULT TRUCKS / RVI 260, 264
AL330 IVECO 70	BD830 FIAT COMMERCIAL 28	BN500 FORD COMMERCIAL 42	BX390 RENAULT TRUCKS / RVI 258
AL350 FIAT COMMERCIAL 32	IVECO 62	BN510 FORD COMMERCIAL 42	BX400 RENAULT TRUCKS / RVI 258
IVECO 70	OM 218	BN520 HINO 50	BX410 RENAULT TRUCKS / RVI 258
AL360 FIAT COMMERCIAL 32	BE220 VOLVO COMMERCIAL 286	BN660 DAF 10	BX420 RENAULT TRUCKS / RVI 258
IVECO 70	BE230 VOLVO COMMERCIAL 288	BN720 MERCEDES-BENZ 148	BX540 NEW HOLLAND 212
AL570 NEW HOLLAND 214	BE240 VOLVO COMMERCIAL 290, 292	BR390 DEUTZ / KHD 20	BY401 FIAT COMMERCIAL 36
AL590 NEW HOLLAND 214	BE740 FORD COMMERCIAL 40	FIAT COMMERCIAL 32	IVECO 72, 74
AL610 NEW HOLLAND 212	BE940 SCANIA 272	IVECO 68, 70	BZ140 MERCEDES-BENZ 182, 200
AL640 IVECO 66	BE950 SCANIA 278, 280	BR550 ISUZU 52	CA5010 IVECO 66
	BE960 FORD COMMERCIAL 40		CA5600 IVECO 70
	BF780 RENAULT TRUCKS / RVI 260		CC5840 MERCEDES-BENZ 170
	BF800 RENAULT TRUCKS / RVI 260, 262		CC5841 MERCEDES-BENZ 168, 170
	BF970 RENAULT TRUCKS / RVI 260		CC5930 MERCEDES-BENZ 154

 CC5931 MERCEDES-BENZ 154, 156	 DC800 MERCEDES-BENZ 150	 DH793 FIAT COMMERCIAL 36	 DS350 IVECO 66, 68
CD490 FORD COMMERCIAL 42	DD600 FORD COMMERCIAL 42	IVECO 76	NEW HOLLAND 214
CD510 FORD COMMERCIAL 40	DD832 FIAT COMMERCIAL 28	DH797 FIAT COMMERCIAL 32	DS351 IVECO 68
CD5750 DAF 10	IVECO 62	IVECO 72	DS381 RENAULT TRUCKS / RVI 258
CE203 FORD COMMERCIAL 40	OM 218	DH798 FIAT COMMERCIAL 36	DS560 SCANIA 274, 276, 278
CE5711 NISSAN 216	DD843 DEUTZ / KHD 20	IVECO 76	DS561 SCANIA 274, 276, 278
CF5370 MERCEDES-BENZ 184, 186, 188, 190	FIAT COMMERCIAL 30, 32	DH799 FIAT COMMERCIAL 36	DS980 FORD COMMERCIAL 40
CG450 SCANIA 272	IVECO 66	IVECO 76	DS990 FORD COMMERCIAL 40, 42
CG9360 IVECO 72	OM 218	DJ040 FORD COMMERCIAL 40	DT570 SCANIA 272
CG9361 IVECO 72	DD844 NEW HOLLAND 214	DJ050 FORD COMMERCIAL 40	DT830 VOLVO COMMERCIAL 286
CH871 BEDFORD 2	DE220 VOLVO COMMERCIAL 286	DJ060 FORD COMMERCIAL 40	DT840 VOLVO COMMERCIAL 286, 288
CH940 BEDFORD 2	DE230 VOLVO COMMERCIAL 288	DJ262 ISUZU 52	DT850 VOLVO COMMERCIAL 292
CH5440 MAN 104	DE240 VOLVO COMMERCIAL 290, 292	DJ270 HINO 50	DT930 VOLVO COMMERCIAL 288, 290
CL233 IVECO 62	DE588 OM 218	DJ280 HINO 50	DV270 SCANIA 278, 280
CL356 FIAT COMMERCIAL 32	DE740 FORD COMMERCIAL 40	DJ970 HINO 50	DV500 MAN 102, 104, 106, 108, 110
IVECO 70	DE910 NISSAN 216	DK042 ISUZU 52	DV520 FIAT COMMERCIAL 28
CL542 NEW HOLLAND 214	DE960 FORD COMMERCIAL 40	DK210 VOLVO COMMERCIAL 286	IVECO 62
CL611 IVECO 62	DF805 RENAULT TRUCKS / RVI 262	DK211 VOLVO COMMERCIAL 286	DV530 RENAULT TRUCKS / RVI 266
CM834 IVECO 66	DF806 RENAULT TRUCKS / RVI 260	DK560 MITSUBISHI 204	DV710 FIAT COMMERCIAL 30
CN01B FIAT COMMERCIAL 28	DF970 RENAULT TRUCKS / RVI 260	DK562 MITSUBISHI 204	IVECO 64, 66
OM 218	DF980 RENAULT TRUCKS / RVI 258	DL160 BEDFORD 2	DV711 FIAT COMMERCIAL 30
CN01E FIAT COMMERCIAL 28	DF990 RENAULT TRUCKS / RVI 258	DL602 RENAULT TRUCKS / RVI 260	IVECO 66
OM 218	DG071 MAN 112, 114	DL630 RENAULT TRUCKS / RVI 266	DV712 NEW HOLLAND 212, 214
CN013 NEW HOLLAND 212	DG080 RENAULT TRUCKS / RVI 262	DL714 DAF 12	DV971 FORD COMMERCIAL 42
CN170 NEW HOLLAND 212	DG082 RENAULT TRUCKS / RVI 262	DL717 DAF 12	NEW HOLLAND 214
CN340 FIAT COMMERCIAL 30	DG083 RENAULT TRUCKS / RVI 262, 264, 266	DL780 FORD COMMERCIAL 40	DW050 RENAULT TRUCKS / RVI 266
CN341 NEW HOLLAND 214	DG640 MAN 102, 104	DL992 FIAT COMMERCIAL 34	DW120 IVECO 66
CN344 FIAT COMMERCIAL 30	DG650 MAN 112, 114, 116, 120, 122, 124	IVECO 74	DW150 IVECO 72
OM 218	DG651 MAN 112	NEW HOLLAND 214	DW151 FIAT COMMERCIAL 34, 36
CN347 FIAT COMMERCIAL 30	DG650 MERCEDES-BENZ 174, 176, 178, 180, 192, 202	DL993 FIAT COMMERCIAL 34	IVECO 72, 74
OM 218	DG853 MERCEDES-BENZ 174, 176, 178, 180, 188, 192, 194, 196, 198, 202	IVECO 74, 76	DW370 MERCEDES-BENZ 148
CN465 NEW HOLLAND 212	DG854 MERCEDES-BENZ 174, 176, 178, 180, 188, 192, 194, 196, 198, 202	DL994 FIAT COMMERCIAL 34	DW372 MERCEDES-BENZ 148
CN467 NEW HOLLAND 212	DG855 MAN 114, 118, 120, 122, 124	IVECO 74	DW373 MERCEDES-BENZ 148
CN468 FIAT COMMERCIAL 28	DH79A FIAT COMMERCIAL 36	DN110 BEDFORD 2	DW380 MERCEDES-BENZ 148
OM 218	IVECO 76	DN500 FORD COMMERCIAL 42	DW381 MERCEDES-BENZ 148, 150
CN470 FIAT COMMERCIAL 28	DH142 NEW HOLLAND 212	DN510 FORD COMMERCIAL 42	DW390 RENAULT TRUCKS / RVI 262, 264, 266
IVECO 62	DH145 FIAT COMMERCIAL 28	DN660 DAF 10	DW470 DAF 12, 14
CN481 NEW HOLLAND 212	IVECO 62	DN663 DAF 10	DW472 DAF 14
CS370 MERCEDES-BENZ 150	DH146 FIAT COMMERCIAL 28	DN722 MERCEDES-BENZ 148	DW473 DAF 14
CS412 MERCEDES-BENZ 162, 164	IVECO 62	DP320 NEW HOLLAND 212	DW480 DAF 10
CS413 MERCEDES-BENZ 160	DH147 FIAT COMMERCIAL 28	DP490 NEW HOLLAND 212	DW531 CUMMINS 4
CX050 DAF 10	IVECO 62	DR392 FIAT COMMERCIAL 32	DX391 RENAULT TRUCKS / RVI 258
CX850 NEW HOLLAND 212	DH152 NEW HOLLAND 214	IVECO 70	DX400 RENAULT TRUCKS / RVI 258
CY010 NEW HOLLAND 212	DH157 FIAT COMMERCIAL 30	DR393 DEUTZ / KHD 20	DX540 NEW HOLLAND 212
CY190 CUMMINS 4	IVECO 66	FIAT COMMERCIAL 32	DZ140 MERCEDES-BENZ 182, 200
CY680 RENAULT TRUCKS / RVI 258	DH158 FIAT COMMERCIAL 28, 30	IVECO 68, 70	DZ141 MERCEDES-BENZ 182, 200
CZ020 SCANIA 274, 276, 278	IVECO 62	DR401 FIAT COMMERCIAL 32	DZ142 MERCEDES-BENZ 182, 200
CZ030 SCANIA 272	DH159 FIAT COMMERCIAL 30	IVECO 70	DZ143 MERCEDES-BENZ 182, 200
DB130 SCANIA 274, 278	IVECO 62	DR402 FIAT COMMERCIAL 32	EA230 VOLVO COMMERCIAL 288
DB131 SCANIA 274, 276	DH152 NEW HOLLAND 214	IVECO 68	EB990 MERCEDES-BENZ 162, 164, 166, 168
DB140 SCANIA 278, 280	DH157 FIAT COMMERCIAL 30	DR555 ISUZU 52	EC220 BEDFORD 2
DC200 FIAT COMMERCIAL 32	IVECO 66	DR556 ISUZU 52	EC330 MERCEDES-BENZ 182
IVECO 70	DH158 FIAT COMMERCIAL 28, 30	DR557 ISUZU 52	EC370 MERCEDES-BENZ 200
DC551 FIAT COMMERCIAL 32	IVECO 62, 64	DR558 ISUZU 52	EC521 MERCEDES-BENZ 182
IVECO 70	DH159 FIAT COMMERCIAL 30	DS310 MERCEDES-BENZ 152	EC522 MERCEDES-BENZ 200
DC790 MERCEDES-BENZ 148	IVECO 62, 64		

NUMERICAL PARTS LIST





Numerische Teilenummernliste • Liste des références produits
Elenco numerico articoli • Lista de referencias





 EC790 MERCEDES-BENZ 148	 FD511 FORD COMMERCIAL 40	 GE221 VOLVO COMMERCIAL 286	 GL992 FIAT COMMERCIAL 34
EC791 MERCEDES-BENZ 150	FD512 FORD COMMERCIAL 40	GE230 VOLVO COMMERCIAL 288	IVECO 74
EC5840 MERCEDES-BENZ 168, 170, 172	FE5711 NISSAN 216	GE240 VOLVO COMMERCIAL 290, 292	NEW HOLLAND 214
EC5850 MERCEDES-BENZ 154, 156	FG9360 IVECO 72	GE911 NISSAN 216	GL993 FIAT COMMERCIAL 34
ED462 BEDFORD 2	FG9361 IVECO 72	GE960 FORD COMMERCIAL 40	IVECO 74, 76
ED5750 DAF 10	FL35D FIAT COMMERCIAL 32	GF970 RENAULT TRUCKS / RVI 260	GL994 FIAT COMMERCIAL 34
EE204 FORD COMMERCIAL 40	IVECO 70	GF980 RENAULT TRUCKS / RVI 258	IVECO 74
EE210 VOLVO COMMERCIAL 286	FL203 DEUTZ / KHD 20	GF981 RENAULT TRUCKS / RVI 258	GM785 DEUTZ / KHD 18
EE211 VOLVO COMMERCIAL 286	FL581 NEW HOLLAND 214	GF982 RENAULT TRUCKS / RVI 258	GM789 DEUTZ / KHD 20
EE220 VOLVO COMMERCIAL 286	FL611 IVECO 62	GF990 RENAULT TRUCKS / RVI 258	GM790 DEUTZ / KHD 18
EE221 VOLVO COMMERCIAL 286	FN01B FIAT COMMERCIAL 28	GG85A MAN 114	GM791 DEUTZ / KHD 22
EE230 VOLVO COMMERCIAL 288, 290	OM 218	GG85F MERCEDES-BENZ 202	GN500 FORD COMMERCIAL 42
EE240 VOLVO COMMERCIAL 290, 292	FN01E FIAT COMMERCIAL 28	GG651 MAN 114, 116	GN510 FORD COMMERCIAL 42
EF031 BEDFORD 2	OM 218	GG851 MERCEDES-BENZ 192	GN520 HINO 50
EF5370 MERCEDES-BENZ 184, 186, 188, 190	FN013 NEW HOLLAND 212	GG856 MERCEDES-BENZ 178, 180	GN521 HINO 50
EG140 FORD COMMERCIAL 40	FN46A FIAT COMMERCIAL 28	GH15A FIAT COMMERCIAL 28, 30	GP320 NEW HOLLAND 212
EG160 FORD COMMERCIAL 40, 42	OM 218	IVECO 62, 64	GP490 NEW HOLLAND 214
EG692 DAF 10, 12	FN170 NEW HOLLAND 212	GH15B FIAT COMMERCIAL 30	GR392 FIAT COMMERCIAL 32
EG700 DAF 10	FN344 FIAT COMMERCIAL 30	IVECO 62, 64	IVECO 70
EG856 MAN 114	OM 218	GH142 NEW HOLLAND 212	GR393 DEUTZ / KHD 20
EH5450 MAN 122	FN347 NEW HOLLAND 214	GH145 FIAT COMMERCIAL 28	FIAT COMMERCIAL 32
EH5451 MAN 118	FN349 FIAT COMMERCIAL 30	IVECO 62	IVECO 68, 70
EL600 RENAULT TRUCKS / RVI 260	OM 218	GH146 FIAT COMMERCIAL 28	GR402 FIAT COMMERCIAL 32
EL601 RENAULT TRUCKS / RVI 260, 264	FN465 NEW HOLLAND 212	IVECO 62	IVECO 68
EM720 MERCEDES-BENZ 148	FN469 NEW HOLLAND 212	GH147 FIAT COMMERCIAL 28	GR550 ISUZU 52
EN720 MERCEDES-BENZ 148	FN470 FIAT COMMERCIAL 28	IVECO 62	GR555 ISUZU 52
ES311 MERCEDES-BENZ 152	IVECO 62	GH152 NEW HOLLAND 212	GR556 ISUZU 52
ES411 MERCEDES-BENZ 158, 160	FN475 NEW HOLLAND 212	GH153 NEW HOLLAND 214	GR557 ISUZU 52
ET830 VOLVO COMMERCIAL 286	FN477 NEW HOLLAND 212	GH159 FIAT COMMERCIAL 30	GR800 HINO 50
ET840 VOLVO COMMERCIAL 286, 288	FN481 NEW HOLLAND 212	IVECO 66	GR810 HINO 50
ET841 VOLVO COMMERCIAL 286	FS414 MERCEDES-BENZ 160	GH671 FIAT COMMERCIAL 32	GS040 MITSUBISHI 204
ET850 VOLVO COMMERCIAL 292	FV670 FORD COMMERCIAL 42	IVECO 68	GS350 IVECO 66, 68
ET930 VOLVO COMMERCIAL 288, 290	FX361 ISUZU 52	GH794 FIAT COMMERCIAL 32	NEW HOLLAND 214
ET931 VOLVO COMMERCIAL 290	FX850 NEW HOLLAND 212	IVECO 72	GS351 IVECO 68
EV500 MAN 104, 108, 110	FY010 NEW HOLLAND 212	GH795 FIAT COMMERCIAL 36	GS641 MITSUBISHI 204
EV501 MAN 106, 110	FZ030 SCANIA 272	IVECO 76	GT570 SCANIA 272
EW470 DAF 12, 14	GB130 SCANIA 274, 278	GH796 FIAT COMMERCIAL 36	GT830 VOLVO COMMERCIAL 286
EW474 DAF 14	GB131 SCANIA 274, 276, 278	IVECO 76	GT840 VOLVO COMMERCIAL 286, 288
EW480 DAF 10	GB140 SCANIA 278	NEW HOLLAND 214	GT841 VOLVO COMMERCIAL 286
EW531 CUMMINS 4	GB141 SCANIA 278, 280	GH797 FIAT COMMERCIAL 36	GT850 VOLVO COMMERCIAL 292
EX030 DAF 10	GC150 HINO 50	IVECO 76	GT851 VOLVO COMMERCIAL 292
EX851 MERCEDES-BENZ 174, 176, 178, 180	GC551 FIAT COMMERCIAL 32	NEW HOLLAND 214	GT930 VOLVO COMMERCIAL 288, 290
EX852 MERCEDES-BENZ 192, 194, 196, 198	IVECO 70	GJ262 ISUZU 52	GV500 MAN 102
EY190 CUMMINS 4	GC790 MERCEDES-BENZ 148	GJ280 HINO 50	GV501 MAN 110
EZ182 RENAULT TRUCKS / RVI 266	GD600 FORD COMMERCIAL 42	GJ970 HINO 50	GV502 MAN 104, 106, 108, 110
EZ184 RENAULT TRUCKS / RVI 266	GD832 FIAT COMMERCIAL 28	GJ980 HINO 50	GV520 FIAT COMMERCIAL 28
EZ192 RENAULT TRUCKS / RVI 262	IVECO 62	GK041 ISUZU 52	IVECO 62
EZ193 RENAULT TRUCKS / RVI 262, 264	OM 218	GK042 ISUZU 52	GV710 FIAT COMMERCIAL 30
EZ195 RENAULT TRUCKS / RVI 262	GD843 DEUTZ / KHD 20	GK043 ISUZU 52	IVECO 64, 66
EZ196 RENAULT TRUCKS / RVI 262, 264	FIAT COMMERCIAL 30, 32	GK530 NISSAN 216	GV711 FIAT COMMERCIAL 30
EZ197 RENAULT TRUCKS / RVI 262, 264, 266	IVECO 66	GK560 MITSUBISHI 204	IVECO 66
EZ202 RENAULT TRUCKS / RVI 260	GD846 IVECO 66	GK890 MITSUBISHI 204	GV714 NEW HOLLAND 212
FA5010 IVECO 66, 70	NEW HOLLAND 212	GK960 HINO 50	GV715 NEW HOLLAND 212, 214
FA5600 IVECO 70	GD847 NEW HOLLAND 214	GL600 RENAULT TRUCKS / RVI 260	GW120 IVECO 66
FB5101 RENAULT TRUCKS / RVI 258	GD848 NEW HOLLAND 214	GL780 FORD COMMERCIAL 40	GW151 FIAT COMMERCIAL 34, 36
FD491 FORD COMMERCIAL 42	GE220 VOLVO COMMERCIAL 286		IVECO 72, 74

 GX410 RENAULT TRUCKS / RVI 258	 HC480 FIAT COMMERCIAL 29	 HT014 SCANIA 273	 JB925 RENAULT TRUCKS / RVI 263, 265, 267
HA337 VOLVO COMMERCIAL 287	IVECO 63	HT015 SCANIA 275, 277, 279, 281	JC054 OM 219
HBS011 RENAULT TRUCKS / RVI 259	HJ057 FIAT COMMERCIAL 31	HT016 SCANIA 275, 277	RENAULT TRUCKS / RVI 259
HBS045 MERCEDES-BENZ 149	IVECO 63	HT017 SCANIA 279, 281	JC055 OM 219
HBS046 MERCEDES-BENZ 151	HJ069 FIAT COMMERCIAL 29	HT018 MERCEDES-BENZ 175, 177, 179, 181, 187, 189, 193, 195, 197, 199, 203	RENAULT TRUCKS / RVI 259
HBS058 MERCEDES-BENZ 149	IVECO 63	HT019 MAN 115, 119, 121, 123, 125	JC199 NISSAN 217
HBS059 MERCEDES-BENZ 149, 151	HJ070 FIAT COMMERCIAL 29, 31		JC204 NISSAN 217
HBS226 MAN 113, 115, 119, 121, 123, 125	IVECO 63, 65, 67		JC232 HINO 51
IVECO 63, 65, 67	HJ237 FIAT COMMERCIAL 29	HT020 MERCEDES-BENZ 175, 177, 179, 181, 193, 203	JC234 FIAT COMMERCIAL 29, 31
MERCEDES-BENZ 175, 177, 179, 181, 187, 189, 193, 195, 197, 199, 203	HJ240 FIAT COMMERCIAL 33		IVECO 63, 67
	IVECO 67, 71	HT021 MERCEDES-BENZ 175, 177, 179, 181, 187, 189, 193, 195, 199, 203	NEW HOLLAND 215
HBS350 MERCEDES-BENZ 183, 201	HJ271 RENAULT TRUCKS / RVI 259		JC267 FIAT COMMERCIAL 33
HBS351 MERCEDES-BENZ 155, 157	HJ285 FIAT COMMERCIAL 37		IVECO 67, 69, 71
HBS352 MERCEDES-BENZ 171, 173	IVECO 77	HT022 VOLVO COMMERCIAL 287	JC268 DEUTZ / KHD 21
HBS366 MAN 119, 121, 123	HL210 DEUTZ / KHD 18, 20	HT026 FIAT COMMERCIAL 33	FIAT COMMERCIAL 33
HBS367 MAN 123	IVECO 62, 66	IVECO 69, 71	IVECO 67, 69, 71
HBS427 VOLVO COMMERCIAL 287	HL363 DEUTZ / KHD 20, 22	HT027 FIAT COMMERCIAL 33	JC291 NISSAN 217
HBS472 MAN 105, 113	IVECO 70, 72, 76	IVECO 69, 71	JC292 NISSAN 217
HBS473 MAN 103, 105, 107, 109, 111	HL399 DEUTZ / KHD 20, 22	HT028 FIAT COMMERCIAL 33	JC321 MITSUBISHI 205
	IVECO 70, 72, 76	IVECO 69, 71	JC329 ISUZU 53
HBS475 MERCEDES-BENZ 185, 187, 189, 191, 193	HL605 SCANIA 272	HT029 FIAT COMMERCIAL 33	JC336 ISUZU 53
	HL5003 IVECO 71	IVECO 69, 71	JC354 HINO 51
HBS482 VOLVO COMMERCIAL 293	HL5004 IVECO 73	HT030 FIAT COMMERCIAL 33	JC355 HINO 51
HBS485 IVECO 67	HL5070 MAN 113, 115, 117, 121, 123	IVECO 69, 71	JC458 FIAT COMMERCIAL 33
HC056 FORD COMMERCIAL 41	HL5077 MERCEDES-BENZ 185, 187, 189, 191, 193	HT031 IVECO 67, 69	IVECO 69
HC057 FORD COMMERCIAL 43		NEW HOLLAND 215	JC603 NEW HOLLAND 215
HC083 NEW HOLLAND 213	HL5080 FIAT COMMERCIAL 33, 37	IVECO 67, 69	JC677 RENAULT TRUCKS / RVI 267
HC104 FIAT COMMERCIAL 33	IVECO 77	NEW HOLLAND 215	JC678 RENAULT TRUCKS / RVI 267
IVECO 71	HL5081 FIAT COMMERCIAL 37	HT033 IVECO 67, 69	JC679 RENAULT TRUCKS / RVI 267
HC118 IVECO 63	IVECO 77	NEW HOLLAND 215	JC732 FIAT COMMERCIAL 29, 31
HC127 FIAT COMMERCIAL 29, 31	HR397 MAN 111	IVECO 67, 69	IVECO 63, 65, 67
IVECO 63, 65	RENAULT TRUCKS / RVI 259	HT034 IVECO 67, 69	NEW HOLLAND 213, 215
HC331 FIAT COMMERCIAL 29	HR602 IVECO 67	NEW HOLLAND 215	JC808 MITSUBISHI 205
OM 219	RENAULT TRUCKS / RVI 259	HT5038 MERCEDES-BENZ 183, 201	JC873 FIAT COMMERCIAL 35
HC335 NEW HOLLAND 213	HR629 FORD COMMERCIAL 43	JA468 FORD COMMERCIAL 43	IVECO 75, 77
HC366 RENAULT TRUCKS / RVI 263	HR666 MERCEDES-BENZ 151, 153	JA849 FIAT COMMERCIAL 33	NEW HOLLAND 215
HC397 NEW HOLLAND 213	HR667 MERCEDES-BENZ 159, 161, 163, 165, 167, 169	IVECO 71	JC874 FIAT COMMERCIAL 35
HC398 NEW HOLLAND 213, 215		JA866 FIAT COMMERCIAL 29, 31	IVECO 75, 77
HC413 FIAT COMMERCIAL 29	HR668 MERCEDES-BENZ 151	IVECO 63	NEW HOLLAND 215
IVECO 63	HR757 MERCEDES-BENZ 149	NEW HOLLAND 213, 215	JD114 MERCEDES-BENZ 153, 163, 165, 167, 169
HC416 FIAT COMMERCIAL 31	HR758 MERCEDES-BENZ 149, 151	OM 219	
IVECO 67	HR769 MERCEDES-BENZ 177	JA893 FIAT COMMERCIAL 33	JD117 MAN 113, 115, 117, 119, 121, 123, 125
HC426 HINO 51	HR775 MAN 103, 105, 107, 109, 111, 113	IVECO 71	MERCEDES-BENZ 175, 177, 179, 181, 187, 189, 193, 195, 197, 199, 203
HC428 FIAT COMMERCIAL 31		JA894 FIAT COMMERCIAL 33	
HC429 FORD COMMERCIAL 43	HR801 DEUTZ / KHD 19, 21	IVECO 67, 71	
HC433 FIAT COMMERCIAL 33	HT002 VOLVO COMMERCIAL 293	JA5009 IVECO 67	
IVECO 69, 71	HT003 VOLVO COMMERCIAL 293	JA5077 MERCEDES-BENZ 183, 185, 187, 191, 193, 201	JD118 MAN 103, 105, 107, 109, 111
HC463 MERCEDES-BENZ 151, 153	HT004 VOLVO COMMERCIAL 291, 293		
HC466 FIAT COMMERCIAL 29	HT005 VOLVO COMMERCIAL 289, 291	JB162 MERCEDES-BENZ 149	JD119 MERCEDES-BENZ 153, 163, 165, 167, 169
IVECO 63	HT006 VOLVO COMMERCIAL 289, 291	JB179 MERCEDES-BENZ 175, 177, 179, 181, 185, 189, 191, 193, 195, 197, 199, 203	
HC474 SCANIA 273	HT007 VOLVO COMMERCIAL 287		JD124 MAN 103, 105, 107, 109, 111
HC475 SCANIA 279, 281	HT008 VOLVO COMMERCIAL 287	JB188 DEUTZ / KHD 19, 21	JD150 MAN 119
HC479 FIAT COMMERCIAL 31	HT009 VOLVO COMMERCIAL 287	IVECO 63, 67	
IVECO 65, 67	HT010 VOLVO COMMERCIAL 287	JB848 MAN 113, 115	JD156 MAN 113, 115, 117, 119, 121, 123, 125
	HT013 SCANIA 273	JB897 RENAULT TRUCKS / RVI 259	JD158 MERCEDES-BENZ 149

NUMERICAL PARTS LIST

Numerische Teilenummernliste • Liste des références produits
Elenco numerico articoli • Lista de referencias

 JD159 MERCEDES-BENZ 149	 JH5168 MERCEDES-BENZ 201	 JJ543 MERCEDES-BENZ 149, 151	 JN311 FIAT COMMERCIAL 33, 37
JD172 DEUTZ / KHD 21, 23 IVECO 71, 73, 77	JH5169 IVECO 73	JJ546 RENAULT TRUCKS / RVI 263, 265, 267	IVECO 73, 77
JD225 FIAT COMMERCIAL 29	JH5172 MWM 207	JJ547 RENAULT TRUCKS / RVI 267	NEW HOLLAND 215
JD229 FIAT COMMERCIAL 29, 31 IVECO 63, 65, 67 NEW HOLLAND 213, 215	JJ068 RENAULT TRUCKS / RVI 259	JJ556 MERCEDES-BENZ 151, 153	JN312 FIAT COMMERCIAL 29
JD250 RENAULT TRUCKS / RVI 263, 265, 267	JJ069 RENAULT TRUCKS / RVI 261, 265	JJ593 IVECO 67	IVECO 63
JD297 MERCEDES-BENZ 151	JJ118 BEDFORD 3	JJ613 RENAULT TRUCKS / RVI 259	NEW HOLLAND 213
JD298 MERCEDES-BENZ 149, 151	JJ119 BEDFORD 3	JM258 BEDFORD 3	JN314 DAF 11
JD299 MERCEDES-BENZ 149, 151	JJ121 FORD COMMERCIAL 41	JM346 RENAULT TRUCKS / RVI 267	SCANIA 275, 277, 279
JD318 RENAULT TRUCKS / RVI 259, 261, 265	JJ135 VOLVO COMMERCIAL 287	JM348 FORD COMMERCIAL 41	JN316 MAN 113, 115, 117, 119, 121, 123, 125
JD319 RENAULT TRUCKS / RVI 263, 265, 267	JJ137 SCANIA 273	JM354 MAN 103, 105, 107, 109, 111	JN322 SCANIA 279, 281
JD320 RENAULT TRUCKS / RVI 267	JJ141 VOLVO COMMERCIAL 287, 289	JM449 FORD COMMERCIAL 41	JN333 SCANIA 273
JD321 RENAULT TRUCKS / RVI 267	JJ177 ISUZU 53	JM450 FORD COMMERCIAL 43	JN336 VOLVO COMMERCIAL 289
JD584 IVECO 67	JJ178 MITSUBISHI 205	JM475 BEDFORD 3	JN346 RENAULT TRUCKS / RVI 263, 265, 267
JD5086 MERCEDES-BENZ 183, 201	JJ190 FIAT COMMERCIAL 33	JM540 FORD COMMERCIAL 41	JN387 FORD COMMERCIAL 41
JD5271 DAF 13, 15	IVECO 69, 71	JM541 FORD COMMERCIAL 41, 43	JN388 FORD COMMERCIAL 43
JD5283 MERCEDES-BENZ 155, 157, 169, 171, 173	JJ191 FIAT COMMERCIAL 33	NEW HOLLAND 213	JN425 HINO 51
JD5350 IVECO 63, 65	IVECO 67, 69, 71	JM661 FIAT COMMERCIAL 29, 31	JN429 MITSUBISHI 205
JD5431 MERCEDES-BENZ 185, 187, 189, 191, 193	NEW HOLLAND 215	IVECO 63, 65	JN475 NISSAN 217
JD5938 IVECO 73	JJ220 NISSAN 217	NEW HOLLAND 213, 215	JN504 ISUZU 53
JD5939 IVECO 73	JJ242 MITSUBISHI 205	JM666 FIAT COMMERCIAL 29	JN505 ISUZU 53
JE107 NISSAN 217	JJ244 ISUZU 53	NEW HOLLAND 213	JN508 HINO 51
JE150 FIAT COMMERCIAL 31, 37 IVECO 63, 65, 67, 77	JJ252 HINO 51	OM 219	JN572 MERCEDES-BENZ 149
JE212 BEDFORD 3	JJ280 MERCEDES-BENZ 175, 177, 179, 181	JM667 FIAT COMMERCIAL 31	JN594 OM 219
JE476 FIAT COMMERCIAL 29 IVECO 63	JJ376 ISUZU 53	NEW HOLLAND 215	RENAULT TRUCKS / RVI 259
JE479 FIAT COMMERCIAL 29, 31 NEW HOLLAND 213 OM 219	JJ406 IVECO 69	JM848 MERCEDES-BENZ 149	JN596 RENAULT TRUCKS / RVI 259
JE639 FIAT COMMERCIAL 33 IVECO 71	JJ416 NEW HOLLAND 213	JM856 MERCEDES-BENZ 157, 159, 161	JN619 MERCEDES-BENZ 149
JE737 HINO 51	JJ456 RENAULT TRUCKS / RVI 263	JM869 DEUTZ / KHD 19, 21	JN621 MERCEDES-BENZ 149
JE5005 IVECO 71	JJ460 MERCEDES-BENZ 159, 161, 165, 169	IVECO 63, 67	JN622 MERCEDES-BENZ 149, 151
JE5035 MERCEDES-BENZ 155, 157, 169, 171, 173	JJ464 MERCEDES-BENZ 157, 159, 161, 163, 167	JM5004 IVECO 67	JN674 ISUZU 53
JF123 RENAULT TRUCKS / RVI 259	JJ468 VOLVO COMMERCIAL 293	JM5026 IVECO 71	JN708 ISUZU 53
JH420 FORD COMMERCIAL 41, 43	JJ473 VOLVO COMMERCIAL 291	JM5075 MERCEDES-BENZ 155, 157	JN745 IVECO 67, 69 NEW HOLLAND 215
JH683 MERCEDES-BENZ 149, 151	JJ474 VOLVO COMMERCIAL 287	JM5172 MERCEDES-BENZ 171	JN748 FIAT COMMERCIAL 31
JH858 MERCEDES-BENZ 203	JJ475 VOLVO COMMERCIAL 293	JM5186 MERCEDES-BENZ 183, 201	IVECO 65, 67
JH859 MERCEDES-BENZ 193, 195, 197, 199	JJ476 VOLVO COMMERCIAL 289, 291	JM5187 MERCEDES-BENZ 183, 201	NEW HOLLAND 213, 215
JH5001 IVECO 67	JJ489 MAN 125	JM5270 MERCEDES-BENZ 183, 185, 187, 189, 191, 193, 201	JN796 FIAT COMMERCIAL 35, 37
JH5018 MERCEDES-BENZ 183	MERCEDES-BENZ 203	VOLVO COMMERCIAL 293	IVECO 73, 75, 77
JH5062 FIAT COMMERCIAL 37 IVECO 77	JJ490 MAN 103, 105, 107, 109, 111	JM7043 MERCEDES-BENZ 185, 187, 189, 191, 193	NEW HOLLAND 215
JH5063 NEW HOLLAND 213	JJ495 MAN 115, 117, 119, 121, 123	JM7064 IVECO 73	JN888 MERCEDES-BENZ 163, 165, 167, 169
JH5071 IVECO 71, 73	MERCEDES-BENZ 179, 181, 185, 187, 189, 191	JM7095 MERCEDES-BENZ 155, 157	JN893 FIAT COMMERCIAL 33
JH5072 MERCEDES-BENZ 183	JJ498 MERCEDES-BENZ 149	JN192 FIAT COMMERCIAL 29	IVECO 69, 71
JH5073 MERCEDES-BENZ 201	JJ518 FIAT COMMERCIAL 35, 37	IVECO 63	JN935 FIAT COMMERCIAL 29
JH5082 MERCEDES-BENZ 149	IVECO 73, 75, 77	NEW HOLLAND 213	IVECO 63
JH5094 MERCEDES-BENZ 155, 157	NEW HOLLAND 215	JN222 DEUTZ / KHD 21	NEW HOLLAND 213
JH5095 MERCEDES-BENZ 169, 171, 173	JJ519 OM 219	FIAT COMMERCIAL 31, 33	JN942 DAF 11, 13
	RENAULT TRUCKS / RVI 259	IVECO 67	JN943 DAF 11, 13, 15
	JJ523 DAF 11, 13	NEW HOLLAND 215	JN949 RENAULT TRUCKS / RVI 261
	JJ524 DAF 13, 15	JN260 MAN 113	JN956 RENAULT TRUCKS / RVI 259
	JJ528 DAF 11	JN266 RENAULT TRUCKS / RVI 267	JN977 MERCEDES-BENZ 175, 177, 179, 181, 187, 189, 193, 195, 197, 199, 203
	JJ529 DAF 11	JN269 RENAULT TRUCKS / RVI 261	JP069 RENAULT TRUCKS / RVI 259
	JJ533 RENAULT TRUCKS / RVI 259	JN273 MERCEDES-BENZ 151	JR580 RENAULT TRUCKS / RVI 259
	JJ542 MAN 103	JN310 FIAT COMMERCIAL 33, 37	JR843 IVECO 71
		IVECO 73, 77	
		NEW HOLLAND 215	

 JR5038 MERCEDES-BENZ 185, 187, 189, 191, 193	 LR948 FIAT COMMERCIAL 29 IVECO 63	 NB929 MAN 113, 115, 117, 119, 121, 123, 125 MERCEDES-BENZ 175, 177, 179, 181, 183, 185, 187, 189, 191, 193, 195, 197, 199, 201, 203 NEW HOLLAND 213, 215	 NJ298 HINO 51 NJ300 HINO 51 NJ301 HINO 51 NJ302 HINO 51 NJ303 HINO 51 NJ305 HINO 51 NJ306 HINO 51 NJ308 HINO 51 NJ463 HINO 51 NJ490 MITSUBISHI 205 NJ496 MITSUBISHI 205 NJ497 MITSUBISHI 205 NJ596 ISUZU 53 NJ619 HINO 51 NJ790 ISUZU 53 NJ791 ISUZU 53 NJ910 MITSUBISHI 205 NJ931 HINO 51 NJ937 ISUZU 53 NJ980 MITSUBISHI 205 NP067 RENAULT TRUCKS / RVI 259 NP068 RENAULT TRUCKS / RVI 259 PA159 FIAT COMMERCIAL 29 IVECO 63 NEW HOLLAND 213 OM 219 PA189 NISSAN 217 PA190 NISSAN 217 PA192 NISSAN 217 PA208 ISUZU 53 PA425 MITSUBISHI 205 PA525 MITSUBISHI 205 PA705 RENAULT TRUCKS / RVI 261, 263 PA706 RENAULT TRUCKS / RVI 259, 261 PA708 RENAULT TRUCKS / RVI 263, 265 PA709 RENAULT TRUCKS / RVI 263, 265 PA714 RENAULT TRUCKS / RVI 259 PA815 MERCEDES-BENZ 149, 151 PA894 ISUZU 53 PA977 ISUZU 53 PB047 IVECO 67, 69 PB172 MERCEDES-BENZ 151, 159, 161, 163, 165, 167, 169 PB177 MERCEDES-BENZ 151, 159, 161, 173, 175 PB180 DEUTZ / KHD 19 PB182 HINO 51 PB224 MAN 121, 123, 125 MERCEDES-BENZ 175, 177, 179, 181, 187, 189, 193, 195, 197, 199, 203
JS075 NEW HOLLAND 215	LS048 FIAT COMMERCIAL 29, 31 IVECO 63, 65	NB934 DEUTZ / KHD 21, 23 IVECO 71, 73, 77	
JS077 NEW HOLLAND 215	LS051 FIAT COMMERCIAL 29, 31 IVECO 63, 65, 67	NB935 DEUTZ / KHD 21, 23 IVECO 71, 73, 77	
JS078 NEW HOLLAND 215	LS083 NEW HOLLAND 215	NB938 DEUTZ / KHD 19, 21 IVECO 63, 67	
KA499 FIAT COMMERCIAL 29, 31 IVECO 63, 65, 67 NEW HOLLAND 213, 215	LS109 FIAT COMMERCIAL 35 IVECO 67, 75	NB939 DEUTZ / KHD 19, 21 IVECO 63, 67	
KA5038 MERCEDES-BENZ 185, 187, 189, 191, 193	LT987 FIAT COMMERCIAL 35 IVECO 75	NB946 DAF 11, 13 NB947 DAF 11, 13, 15 NB956 DAF 13, 15	
KD929 RENAULT TRUCKS / RVI 259	NA736 FORD COMMERCIAL 41	NB964 MAN 103, 105 NB966 MAN 115 NB967 MAN 103, 105, 107, 109, 111, 113	
KD930 IVECO 67, 69	NA748 FORD COMMERCIAL 41, 43 NA764 FORD COMMERCIAL 41, 43	NB973 MERCEDES-BENZ 149 NB974 MERCEDES-BENZ 149 NB975 MERCEDES-BENZ 149, 151 NB977 MERCEDES-BENZ 173, 175, 177, 181 NB978 MERCEDES-BENZ 151, 153, 159, 161, 163, 165, 167, 169 NB979 MERCEDES-BENZ 151, 157, 159, 161 NB984 MERCEDES-BENZ 177	
KD931 RENAULT TRUCKS / RVI 259	NA784 RENAULT TRUCKS / RVI 259 NA965 FORD COMMERCIAL 41, 43 NA5038 FIAT COMMERCIAL 29 NA5039 FIAT COMMERCIAL 29 IVECO 63 OM 219 RENAULT TRUCKS / RVI 259	NF013 RENAULT TRUCKS / RVI 263 NF603 RENAULT TRUCKS / RVI 259 NF604 RENAULT TRUCKS / RVI 259 NF636 RENAULT TRUCKS / RVI 259 NF715 RENAULT TRUCKS / RVI 259, 261 NF745 RENAULT TRUCKS / RVI 267 NF754 MAN 103, 105, 107, 109, 111, 113 RENAULT TRUCKS / RVI 261 NF831 RENAULT TRUCKS / RVI 267 NF832 RENAULT TRUCKS / RVI 263, 265, 267 NF837 RENAULT TRUCKS / RVI 259, 261 NF839 RENAULT TRUCKS / RVI 263, 265 NF840 RENAULT TRUCKS / RVI 263, 265 NF883 RENAULT TRUCKS / RVI 259 NF885 RENAULT TRUCKS / RVI 259	
KD5001 FIAT COMMERCIAL 35, 37 IVECO 73, 75	NA5040 FIAT COMMERCIAL 29, 31 IVECO 63, 65, 67	NF831 RENAULT TRUCKS / RVI 267 NF832 RENAULT TRUCKS / RVI 263, 265, 267 NF837 RENAULT TRUCKS / RVI 259, 261 NF839 RENAULT TRUCKS / RVI 263, 265 NF840 RENAULT TRUCKS / RVI 263, 265 NF883 RENAULT TRUCKS / RVI 259 NF885 RENAULT TRUCKS / RVI 259	
KD5002 FIAT COMMERCIAL 37 IVECO 77	NA5041 FIAT COMMERCIAL 29 IVECO 63, 67	NJ225 NISSAN 217 NJ228 NISSAN 217 NJ230 NISSAN 217 NJ231 ISUZU 53 NJ232 ISUZU 53 NJ233 ISUZU 53 NJ236 ISUZU 53 NJ257 MITSUBISHI 205 NJ258 MITSUBISHI 205 NJ297 HINO 51	
KG405 FORD COMMERCIAL 41	NA5042 IVECO 67		
KG406 FORD COMMERCIAL 41	NA5043 FIAT COMMERCIAL 29 OM 219		
KG431 BEDFORD 3	NA5074 MERCEDES-BENZ 149, 151		
KG485 FORD COMMERCIAL 41	NA5101 FORD COMMERCIAL 41, 43 NA5120 MERCEDES-BENZ 155, 157, 169, 171, 173		
KG936 FIAT COMMERCIAL 29, 31 IVECO 63, 65	NA5121 MERCEDES-BENZ 155, 157, 169, 171, 173		
KK180 NEW HOLLAND 213	NA5131 MERCEDES-BENZ 149, 151		
KK195 FIAT COMMERCIAL 29, 31 NEW HOLLAND 213, 215 OM 219	NA5156 MAN 103, 105, 107, 109, 111, 113 NA5181 MAN 103, 105, 107, 109, 111, 113 RENAULT TRUCKS / RVI 259, 261, 265		
KK196 FIAT COMMERCIAL 29, 31 NEW HOLLAND 213, 215 OM 219	NB460 BEDFORD 3		
KK972 NEW HOLLAND 213	NB618 SCANIA 273, 275, 277, 279, 281		
KK5599 RENAULT TRUCKS / RVI 259	NB619 SCANIA 273, 275, 277, 279, 281		
KK5608 IVECO 67, 69	NB688 FORD COMMERCIAL 41, 43 NB928 MAN 113, 115, 117, 119, 121, 123, 125 MERCEDES-BENZ 175, 177, 179, 181, 183, 185, 187, 189, 191, 193, 195, 197, 199, 201, 203		
KL137 FIAT COMMERCIAL 37 IVECO 73, 77			
KL351 FIAT COMMERCIAL 29 NEW HOLLAND 213 OM 219			
KT632 BEDFORD 3			
KT633 FORD COMMERCIAL 41			
KT638 FORD COMMERCIAL 41, 43			
KV477 FIAT COMMERCIAL 33, 35, 37 IVECO 71, 73, 75, 77			
KV482 FIAT COMMERCIAL 33 IVECO 71			
LA190 RENAULT TRUCKS / RVI 259			
LA602 FIAT COMMERCIAL 33, 35 IVECO 71, 75, 77			
LA646 NEW HOLLAND 213			
LB096 FORD COMMERCIAL 43			
LB802 RENAULT TRUCKS / RVI 263, 265			
LB955 MERCEDES-BENZ 151, 153, 159, 161, 163, 165, 167, 169			
LC280 RENAULT TRUCKS / RVI 259			
LC281 RENAULT TRUCKS / RVI 259			
LC282 RENAULT TRUCKS / RVI 259			

INTERCHANGE OE → PAYEN

Vergleichsliste OE → Payen • Références croisées 1ère Monte → Payen
Intercambio OE → Payen • Intercambio entre equipo original y Payen

OE reference	▲ Payen	OE reference	▲ Payen	OE reference	▲ Payen	OE reference	▲ Payen	OE reference	▲ Payen
0000146711	HC366	0241333	JJ523	0682674	DL714	1104425002	BJ390	1273501	PA815
0000157426	PA709	02419798	HR775	0682677	DL717	1104425004	BJ390	1275083	NB947
0000321459	HC366	0242 1820	NB935	0682680	DW470	1104425005	BJ390	1275084	NB956
0000321961	HC366	0242 3697	HR775	0682686	EW480	1104425505	BJ390	1283129	BW480
0000322666	HC366	02421819	NB935	0682687	E6700	1104425507	BJ390	1283752	BW470
0000323477	EZ192	02421820	NB935	0682688	E6692	1111410902	BR550	12904372	AH5420
0000323479	EZ192	02423697	HR775	0682689	DN660	1111411040	BJ260	12904380	AG7340
0000323761	DW390	02910048	HL210	0682690	EW470	1111411080	BJ260	1298923	BW470
0000530296	HR769	02911536	HL363	0682885	DW480	1111411150	BJ260	1302827	HT014
001 997 74 47	PA815	02928810	HL399	0683106	EW470	1111411700	BR550	1304593	AN460
0019971241	PA815	02928813	GM791	0683107	EW480	1111411701	BR550	1305959	JN322
0019972641	LB955	02928832	FL203	0683191	EW474	1111411710	BR550	131039	JN314
0019974141	LB955	02928976	GM785	0683337	DW473	1111411960	BR550	1312934	HT015
0029970847	NB975	02928981	GM790	0683350	CD5750	111151021	BJ970	1313459	BV270
0059972647	NB966	02928994	HL210	0683351	ED5750	111151730	BN520	13134598	BV270
0059979047	NB975	02929333	GM789	0683373	DW472	111151781	BV590	131444	JJ138
0069973347	NB966	0343407001	NJ233	0730024	NB460	1111730100	JN674	131571	JN333
0069978547	NB979	0376279	BW470	0730080	KT633	1111730101	JN674	131614	JJ137
0074659	BW480	0389276	JJ528	0750121	JN942	1111730550	JN708	1320372	BW470
0089971547	NB975	040100043	GJ980	0751275	BL710	1111730590	JN505	1320596000	PA189
0089971647	NB975	040100087	GJ280	0753623	JJ523	1112125000	JJ220	1320596001	PA189
0094701	BN660	040100088HS	DJ270	0761513	AX050	1113670720	JJ244	1320596002	PA189
0098504	JJ529	040100089	GK960	0996090400	GF980	1114036	HT016	1320797000	PA190
0098519	JJ524	040100102	GJ970	1010196025	GE911	1125690010	PA894	1320725000	PA192
0099978547	NB975	040100152	GN520	1010196525N	FE5711	1125690551	PA977	1320725001	PA192
0099978947	NB973	040100158	GN521	1010197025	GK530	113105245F	NA784	1327997500	JN475
0099979447	NB979	0415 3728	PB180	1010197128	GK530	11341289948	PA815	1339668	AD5750
00A103085A	NB973	0415 7234	JM869	1010396025	GE911	1141150360	JC329	1400596001	JC291
0109970947	NB973	04150782	NB938	1010396026	GE911	1141450830	JC336	1400596003	JC199
0109973347	NB973	04150783	NB939	1010396027	GE911	1141450890	JC336	1400596004	JC204
0109979047	NB975	04153728	HR801	1020500058	HR757	11490525	PB180	1400897000	JC292
01170604	NB935	04157654	BM780	108719	HC118	1150140122	JH683	1418493	JA468
0119972247	NB978	04221154	HR801	1096250800	NJ236	116117	AX050	1428996	HC056
0119975647	NB977	04230392	NB939	1096251120	NJ596	11612777	HR397	1428997	HC057
01212716	HT019	04232267	NB939	1096251280	NJ233	116533ESA	KG405	1444133	GD600
013 997 14 47	NB966	04237267	NB939	1096251930	NJ236	116534ESA	KG406	1444135	DD600
0139971447	NB929	04271262	AH5590	1096251950	NJ596	118729	E6700	14462880	KG936
014 997 13 47	NB966	04271263	AH5580	1096252800	NJ790	118730	E6692	14462882	KG936
0149971347	NB929	04271264	AH5570	1096253160	NJ236	12015120	NB068	1447267	GE960
0149971647	NB978	04285624	AG9400	1096253190	NJ937	1209970346	NB973	1447268	DE960
0149974647	NB928	04285624BF6M2013	AG9400	1096253290	NJ791	12160435	AH5420	1447269	BE960
0159979048	HT018	04285625	AG9410	1096253630	NJ596	12160608	JH5172	1448485	KT638
0159979148	HT018	04285625BF6M2013	AG9410	1096253840	NJ596	1226865	JJ528	1461765	BE960
0179977447	NB974	04285626	AG9420	1096253848	NJ596	12270877	JH5172	1463704	FV670
0189975247	NB973	04285626BF6M2013	AG9420	1096254040	NJ790	12272403	AH5460	1463705	FV670
0197Y2	GX410	04289406	AG9390	1096254050	NJ791	12272404	AH5490	1463783	GE960
0199971947	NB973	04289407	AG9380	1104296025	DE910	1227890010	NJ225	1463784	GD600
0199976647	NB928	04289408	AG9370	1104296525N	CE5711	1227996000	NJ230	1463786	DE960
02148905	NB934	04862518	BH790	1104497500	BK530	1227997000	NJ230	1463787	DD600
0219971847	NA5131	0490301	JE212	1104497501	BK530	1227997001	NJ230	1470910	PB180
0219972147	NA5121	0490491	JM348	1104497502	BK530	1227997002	NJ230	1474550	PB180
0219974047	NA5120	0490525	PB180	1104497503	BK530	12279J2000	NJ228	1486852	PB180
0219975347	NA5121	0578785600	NF745	11044NC000	AE5710	12279J2001	NJ228	1486853	PB180
02230216	BM780	0682231	EW480	11044NC001	AE5700	12279Z5001	NJ228	1490506	PB180
0239978447	NA5131	0682667	CX050	11044Z5000	BJ390	125000	DC551	1490525	PB180
0241144	JN943	0682673	DN663	11044Z5001	BJ390	126907123	JM848	1499652	FV670

OE reference	▲ Payen	OE reference	▲ Payen	OE reference	▲ Payen	OE reference	▲ Payen	OE reference	▲ Payen
1525251	PB180	1813948	DJ040	1902231	GH794	1905579	DD832	1905968	DW120
15566	PA705	1813949	EG140	1902234	GD832	1905580	GD843	1907574	GV520
1564185	BE960	1813950	DS990	1902235	GD843	1905581	DD843	1907575	GV710
1564186	BD600	1813951	EG160	1902243	CN470	1905582	GL994	1907664	GW120
1564187	BE960	1817048	JM540	1902244	FN470	1905583	DL994	1907668	GS351
1564188	BD600	1817049	JM541	1902245	CN470	1905584	GL993	1907669	DS351
15683	PA714	1819540	DJ050	1902246	FN349	1905585	DL993	1907681	DW151
1568834	PB180	1819541	DJ060	1902247	FN01E	1905586	DR393	1907682	GW151
15690	PA706	1819544	BE740	1902248	FL35D	1905587	DR392	1907748	GV710
1574857	BD600	1824481	JJ121	1902250	FN46A	1905588	DC200	1907749	DV710
157968	PA708	1824483	JH420	1902251	CN468	1905589	DH79A	1907799	DS381
15965010457	HT019	1844762	BJ040	1902259	DC551	1905590	GH796	1907801	DS381
1596529	PB180	1844763	BE740	1902260	GC551	1905591	DH799	1907802	DS381
1600002	AY370	1851747M1	NA736	1902261	GC551	1905692	DV711	1907811	HC479
1602146	BN510	1873577	BX540	1902262	DC551	1905693	GV711	1907812	HC480
1602147	BN510	187486	JA866	1902263	DC200	1905707	GH795	1907832	BV710
1620378	PB180	1878100260	FX361	1902290	DR401	1905708	DH798	1907833	AN460
1644647	HR801	1878100300	FX361	1902466	BH790	1905731	GH795	1907834	AN470
1651532	PB180	1878102471	GJ262	1902545	DH158	1905732	DH798	1907835	BV520
1651865	JJ456	1878102472	GJ262	1902546	DL994	1905795	BH790	1907837	BS340
170610	BE950	1878102473	GJ262	1902547	DL992	1905797	DH797	1907838	BW160
1706100	JN322	1878102474	GJ262	1902549	DH157	1905798	GH794	1907847	GW151
1708111	CD490	1878102640	DJ262	1902550	GH159	1905799	DH79A	1907848	DW151
1710277	AD510	1878104040	GR550	1902551	DV711	1905800	GH797	1907849	GS351
1710281	AD510	1878104041	GR550	1902552	GV711	1905801	DH799	1907850	DS351
1710291	AD490	1878104044	GR550	1902553	HC127	1905802	GH796	1907851	GV520
1710293	AD490	1878106090	GR550	1902575	GS350	1905808	GH796	1907852	DV520
1710683	NA748	1900425	FN470	1902587	GH146	1905903	JR843	1907853	GV710
1710835	HR629	1900635	FN347	1902589	GH146	1905913	CN468	1907854	DV710
1716218	KG405	19007873	GH15A	1902590	DV520	1905917	HC433	1907863	FN46A
1716221	KG406	1901162	GL994	1902636	AY370	1905926	GH147	1907864	CN468
1717613	AE200	1901303	DP490	1902637	BR390	1905927	DH147	1907865	GH147
1717801	JM348	1901384	FN344	1902639	JC873	1905928	FN470	1907866	DH147
1743591	FD511	1901864	DH147	1902647	HC466	1905929	CN470	1907867	GH145
1743592	FD511	1901876	DR393	1902648	GH15B	1905930	GH159	1907868	DH145
1743593	FD511	1901882	DH797	1902649	DH159	1905931	DH157	1907869	FN470
1743738	CD490	1901885	DH793	1902650	GL993	1905934	GC551	1907870	CN470
1743744	CD510	1901888	DD832	1902651	DL993	1905935	DC551	1907871	GH15A
1743745	CD510	1901897	DD843	1904840	LS051	1905936	GC551	1907872	DH158
1743746	CD510	1901905	CN340	1904884	HC413	1905937	DC551	1907873	GH15B
1756141	BV520	1901908	CN01B	1904899	KV482	1905940	DC200	1907874	DH159
1762246	JM449	1901911	AL350	1904915	JC055	1905941	FL35D	1907930	GH15B
1762293	JM450	1901914	DC200	1905507	JA894	1905942	AL350	1907934	GV711
177014	AZ020	1902061	BH790	1905541	JC267	1905950	GR393	1907935	DV711
1770148	AZ020	1902211	HC466	1905549	JA893	1905951	GR402	1907936	GH159
1780566	FD491	1902212	GH147	1905552	JN893	1905953	GR392	1907937	DH157
1780567	FD491	1902219	HC127	1905560	GL992	1905955	DR401	1907938	GH145
1780571	FD491	1902222	GH15B	1905561	DL992	1905956	CN01B	1907939	DH145
1780578	FD512	1902223	DH159	1905571	FN46A	1905959	GS350	1907940	DH159
1780582	FD512	1902224	GR392	1905572	GH146	1905960	DS350	1907959	GL992
1791178	NB688	1902225	DR392	1905573	DH145	1905961	GH146	1907960	DL992
1794576	JA468	1902226	GH15A	1905574	GH15A	1905962	DH146	1907961	GL994
1803774	CE203	1902227	GL994	1905575	DH158	1905963	GD832	1907962	DL994
1803775	CE203	1902228	GL992	1905576	GH15B	1905964	FN344	1907963	GL993
1803798	AE200	1902229	GR393	1905577	DH159	1905965	CN344	1907964	DL993
1813946	DJ040	1902230	GR402	1905578	FN01B	1905966	DV520	1907986	BR390

INTERCHANGE OE → PAYEN

Vergleichsliste OE → Payen • Références croisées 1ère Monte → Payen
Intercambio OE → Payen • Intercambio entre equipo original y Payen

OE reference	▲ Payen	OE reference	▲ Payen	OE reference	▲ Payen	OE reference	▲ Payen	OE reference	▲ Payen
1907987	AY370	1908690	DW151	1909672	DH152	1940047	GH142	249448	E6692
1908009	DE588	1908691	GW151	1909712	GD848	1940048	GH142	249526	JJ137
1908016	GS350	1908693	DW150	1909713	DD844	1940050	FY010	2495265	JJ137
1908023	DS350	1908694	GW151	1909726	DH152	1940051	GP490	257375	BG660
1908027	JA849	1908695	DW151	1909764	GD847	1940053	GP490	257381	BE940
1908028	JE476	1908701	DH79A	1909765	DD844	1940054	DV712	2573814	BE940
1908035	JC458	1908702	GH797	1909767	DP320	1940057	GV715	258458	JN333
1908036	JE479	1908703	DH799	1909976	DD844	1940058	DV712	2584589	JN333
1908040	FN01E	1908704	GH796	1909983	GH142	1940059	GV715	2584597	JN314
1908041	DD832	1908705	DH798	1909985	DH142	1940060	DP490	259775047	NA5121
1908042	GD843	1908706	GH795	1909989	DP320	1940061	DP490	260306	CX050
1908043	DD843	1908818	DW151	1930197	GV715	1940074	GP320	269548	JD5271
1908044	DR393	1908819	GW151	1930249	CY010	1940075	DP320	2700E6700A1	NB688
1908045	DR392	1908821	DW150	1930259	FN469	1940076	FN347	2700E6700B	NB688
1908046	DC200	1908822	GW151	1930260	CN467	1940077	FN013	2700E6701C	KT638
1908047	DC551	1908823	DW151	1930273	GP320	1940078	CN341	2701E6051C	BE960
1908048	GC551	1908881	GL992	1930274	DP320	1940079	FN013	2701E6051D	BE960
1908049	DC551	1908882	GL994	1930369	GD848	1940080	CN013	2701E6584	JM449
1908051	DC200	1908883	DL992	1930373	GH153	1940081	AN010	2701E6781C	HC056
1908052	FL35D	1908884	DL994	1930433	GP490	1940082	FN013	2703E6051D	BD600
1908053	CL356	1908885	GL993	1930435	DP490	1940083	CN341	2703E6584	JM450
1908057	GR393	1908886	DL993	1930449	HC335	1940084	FN013	2703E6781C	HC057
1908058	GH671	1909307	CN341	1930455	HC398	1940085	CX850	2703E6C037	DD600
1908059	DR402	1909511	FN347	1930457	HC335	1940086	CN013	2703E9448A	JA468
1908060	GR392	1909512	CN341	1930570	DD844	1940087	CN013	2704E9448A	JA468
1908061	GH671	1909516	CX850	1930593	GV715	1940091	DP320	2707610	GE220
1908062	DR401	1909543	GH152	1930797	CY010	1940092	GP320	270765	DT840
1908063	CN01B	1909544	DP490	1930800	CY010	1940102	FN013	2707669	DK210
1908065	GD832	1909545	FN347	1930848	DP490	1940106	FN347	2707685	DK211
1908066	FN344	1909546	CN341	1930887	HC335	1940111	CY010	2707719	DE220
1908069	CN344	1909547	FN475	1930890	HC398	1940122	FY010	270772	DT850
1908129	GH795	1909549	FN013	1940003	DD844	1940123	CY010	270774	ET830
1908130	DH798	1909550	CN013	1940004	HC335	1940124	CN467	2707743	ET830
1908201	LT987	1909551	FN013	1940005	HC398	1940125	FN469	270775	ET840
1908317	GW120	1909552	CN013	1940010	GD847	1940126	CY010	2707784	EE211
1908332	GH671	1909556	CX850	1940016	GD848	1940127	FY010	2707883	HT005
1908333	DR402	1909564	CN465	1940023	FN465	1940135	CY010	270789	BT930
1908335	DR401	1909565	FN347	1940024	DP490	1ADKN6701A	KT638	2707891	BT930
1908343	DR393	1909566	CN341	1940025	DH152	2031096001	JE107	270789X6	DT930
1908344	GR393	1909567	FN465	1940026	DP490	2031096002	JE107	2708272	AH870
1908345	DR392	1909568	CN465	1940027	GH153	203F6051AA	BE960	2708277	AH940
1908346	GR392	1909569	FN013	1940028	GH152	212171	AX050	2708E6C037	DD600
1908350	GW151	1909570	CN013	1940029	GH152	2152429	JJ138	2709344	AH940
1908358	GW151	1909571	GH142	1940030	CN467	215246	JJ137	2709345	AH870
1908359	GL992	1909572	DH142	1940031	CN465	229014	AG7340	270949	BT850
1908360	GL994	1909573	FN013	1940033	CN465	229977647	NA5120	2709491	DT850
1908369	HC428	1909574	AN010	1940034	FN469	231938	NB619	270949X6	DT850
1908389	HC428	1909575	FN013	1940035	FN465	2319382	NB619	270950	HT002
1908390	HC331	1909576	CN013	1940036	FN465	237713	EX030	2709509	HT002
1908399	DW150	1909594	AN460	1940038	AN460	2380100220	BJ980	2709574	GE220
1908400	DL992	1909596	FN465	1940039	FN475	2414111	NA736	2709582	DE230
1908401	DL994	1909597	CN465	1940040	FN475	2415344	NA736	2711216	HT002
1908402	GL993	1909598	FN347	1940042	FN477	2415391	NB460	2711307	ET850
1908403	DL993	1909599	CN341	1940044	CY010	2418F475	NB934	271155	HT003
1908674	GW120	1909612	FN475	1940045	DH142	2421819	NB934	2711554	HT003
1908675	DW120	1909671	GH152	1940046	DH142	245279	CX050	271156	HT004

OE reference	▲ Payen	OE reference	▲ Payen	OE reference	▲ Payen	OE reference	▲ Payen	OE reference	▲ Payen
2711562	HT004	276035	DT930	346216	BT570	36883106	KT633	4157247	JB188
2711570	HT005	276039	ET841	3520100580	JJ460	371503	JJ138	4184903	JD172
271158	HT006	276112	ET931	3520100880	JJ464	3715034	JJ138	420025	JJ135
2711588	HT006	2761229	ET930	3520101980	JJ464	373472	BS560	4200259	JJ135
271159	HT007	276123	ET930	3520102380	JJ460	373473	BS560	420618	GT840
2711596	HT007	2761237	ET930	3520102621	CS413	3761420080	JD119	420641	GT840
271160	HT008	2761245	EE240	3520160120	AS410	376729	BW470	420642	GT840
2711604	HT008	276125	GT851	3520160421	JM856	3802375	EY190	420740	JJ135
271161	HT009	2761252	ET850	3520160620	AS410	384702	JJ137	4210100380	EX851
2711612	HT009	276194	GT850	3520160720	AS410	387503	BT570	4210100408	EX851
271162	HT010	276198	ET931	3520160921	JM856	38821480	NA5038	421025	JJ141
2711620	HT010	2768166	BT840	3520161220	AS410	389348	BN660	4210258	JJ141
272589	NB618	2768216	GT830	3520161320	AS410	3905794	NA965	4220100480	EX852
275 5254	GE221	276916	AF5280	3520161420	AS410	3921394	BW530	4220100608	EX852
275334	EA230	291159	BT570	3520530296	HR769	3925462	EG140	4220160020	BG850
275460	HT022	2991540	AY370	3525861290	FS414	3926004	EG140	4220160022	BG850
2754604	HT022	2992575	CG9360	3530103708	ES411	3927569	BE740	4220160220	BG850
2755213	BK210	2996302	FG9361	3530104808	ES411	3976375	JM541	4220160420	BG850
275524	EE210	2996303	CG9361	360 053 00 96	PB177	3977023	BS990	4220160620	BG850
2755247	EE210	2996504	FG9360	3610643	BH790	3981074	BS980	4220530196	PB224
275525	BE220	3.681E037	AG450	3640100180	HC463	40000040	NA784	4229900301	HBS226
2755254	BE220	30187486	JA866	3640100380	DS310	40000720	NA5039	4229900401	HBS226
275528	EE220	3081300509	JJ242	3640101180	JJ556	40002810	NA5040	4230100080	DG853
2755288	EE220	3110706300	NJ490	3640102108	ES311	40003630	NP068	4230100380	DG853
275531	EE230	3110706301	NJ490	3640102208	ES311	40003634	NP068	4230100880	DG853
2755312	EE230	3120132100	BS930	3640104020	DS310	40003637	NP068	4230160220	BG850
275534	EA230	3121233300	NJ980	364016027	BS310	40003640	NP068	423145	JN336
2755346	EA230	3140100480	CS370	3640160320	BS310	40003650	NP067	4231452	JN336
275548	BE240	3140106020	CS370	3640160620	BS310	40003657	NP067	4235860090	DG853
2755486	BE240	3140107708	ES311	3640160720	BS310	40004000	NA784	4241410480	JD117
275551	BE230	3140108008	ES311	3660100580	JJ464	40004290	NA784	4246054	JJ475
2755510	DE230	3140161120	BS310	3660100680	JJ464	40007	CE203	424918	JJ135
275554	DT850	3145860190	CS370	3660100720	AS410	40100070	NP067	4249181	JJ135
275555	EE240	3150300080	NB984	3660100780	JJ460	40100080	NP068	424919	JJ141
2755551	EE240	3210066	BD830	3660103708	EB990	40100301	NB946	4249199	JJ141
2755668	BK210	3210089	AL360	3660103820	CS412	40100320	NP067	424983	ET930
2755676	HT010	3210095	AN360	3660104408	EB990	40100321	NP068	42531636	NP067
275716	EE221	3210096	BC550	3660106120	CS412	40100324	NP068	4279436	JC054
2757169	EE221	3210107	BR390	3660160020	AS410	40100330	NP067	4279438	JC055
2757185	EE211	3210109	BR390	3660160021	JN888	40100331	NP067	428297200	JJ068
2757383	HT010	3210110	AY370	3660160120	AS410	40100334	NP067	441 014 00 22	JJ280
275740	BK210	3214089	BS340	3660160220	AS410	40100340	NP068	4420110059	HT018
2757409	BK210	3214127	BD830	3660160321	JN888	40101333	NA5041	4420140222	JH859
2757557	HT003	3214130	AL360	3660160620	AS410	40101393	NA5043	4420160020	BG850
2757722	HT009	3214132	AN360	3660160720	AS410	4025865090	GG851	4420160121	JN977
275774	BT830	3214134	BC550	3660530058	HR769	4030140322	JH858	4420160320	BG850
2757748	GT830	323662	HT013	3660530158	PB177	4031420380	JB179	4420160420	BG850
275774X2	DT830	3283333	AY190	3661410580	JD114	4035865090	DG850	4420160520	BG850
275776	DT830	3283569	AY190	3661410780	JD114	4035866090	DG850	4420160621	JN977
2757789	HT007	3310392	AL350	3661420180	JD119	4039900501	HBS226	4420160721	JN977
275779	GT840	338643	NB618	3661420480	JD119	4040140022	JJ489	4420530196	PB224
2757797	BT840	3386430	NB618	366303	NB619	4058790	AH5370	4421411780	JD117
275779X2	DT840	3410530096	HR666	367569	BE950	406307	JE479	4430140022	JH858
275781	DT840	3460160120	AH5390	36812136	AE200	4089648	CY190	4440100120	DG854
275784	GT840	346143	BG660	3681E034	AG450	4142114	NA784	4440140022	JJ489
2760346	GE230	3461431	BG660	3681E035	AG450	4153728	PB180	4441458100	NJ233

INTERCHANGE OE → PAYEN

Vergleichsliste OE → Payen • Références croisées 1ère Monte → Payen
Intercambio OE → Payen • Intercambio entre equipo original y Payen

OE reference	▲ Payen	OE reference	▲ Payen	OE reference	▲ Payen	OE reference	▲ Payen	OE reference	▲ Payen
4441458181	NJ233	4679630	LS083	4790927	BP480	5000336057	GL600	5001830001	EZ184
4441459700	NJ233	4681051	JN310	4790928	AN470	5000336059	GF970	5001830801	EZ184
4441459781	NJ233	4681248	BV520	4790929	BV710	5000336163	GL600	5001830807	GL600
4470100720	DG850	4686958	KL137	4791426	JJ518	5000336164	GF970	5001830814	EZ182
4470140022	JJ495	4690351	AN460	4792644	ET930	5000336300	GF990	5001830817	DL602
4518878	AL330	4690380	AN470	4792644	JJ476	5000338022	GF990	5001836510	GX410
4528390	AL640	469336	ET930	4794848	JJ468	5000556084	GL600	5001836511	DX391
4528901	LS109	4695777	BV520	4810554	BH790	5000560821	NB966	5001853924	NP067
4530174	JN796	4696011	JN311	4818778	BV520	5000666061	BV530	500300288	JC234
4531110	JA893	4696355	BV710	4828150	HBS011	5000667619	BL600	500300289	JC603
4531113	JA894	470 261-9	HBS482	4829433	KD5001	5000678104	NF831	500306170	AY680
4539179	AL350	4704811	JC234	48301145	BS340	5000678440	JN266	500306171	AY690
4553286	AN460	4707536	BD830	4830145	BV520	5000678639	BW050	500306172	AY700
4569185	KG936	4708956	BV520	4830224	HR602	5000684118	BW920	5003065108	LB802
4570100105	EF5370	4708957	BV710	4836317	BS340	5000691089	BL600	5003087026	NF831
4570106220	DZ142	4710881	JR580	4836717	BS340	5000694668	NF832	5003087031	NF832
4570107320	CF5370	4711837	HC416	4837051	AB5100	5000786229	PA709	500309014	JM7064
4570150180	JR5038	4712546	HC413	4837141	JC055	5000793008	EZ193	500314225	NF883
4570160021	JM7043	471480	BT840	4837222	LS048	5000793009	EZ195	500315684	NF885
4570160121	JM5270	471520X2	DT840	4837347	DS381	5000793019	DG082	500316112	JJ613
4570160221	JM5270	4716458	NP067	4837349	DS381	5000793036	DG080	500317403	JN956
4570161120	AF5370	4716750	NP068	4837594	JN796	5000793037	DG082	500323989	JM5026
4571410080	JD5431	4721316	JC603	4839530	JC873	5000793038	EZ195	5003338022	GF990
4571420080	JA5077	4722993	BP480	4840063	JC873	5000793039	EZ193	500348329	FA5010
4572010080	KA5038	4723325	BH790	4840064	JC873	5000793222	DG083	500348331	CA5010
4579900201	HBS475	4731005	BL991	4845136	JN935	5000793626	DG083	500354411	CY680
4594861	LS109	4741299	KV482	4845138	JN748	5000793734	DG083	500354580	HBS485
4599561	KA499	4741300	LS109	4845364	AY020	5000793752	DV530	500366181	DX400
4599809	LS048	4744488	LA190	4846584	JR580	5000793902	EL601	500366528	DX391
4601981	JC732	4754068	BV710	4846870	BV520	5000794179	DL602	500369188	KK5599
4602162	JD5350	4754069	BV710	4846871	BP480	5000794311	DL602	500369483	CY680
4604615	LS051	4755836	BH790	4846872	BV710	5000814478	DL630	500382172	AA5010
4608942	KA499	4757271	AN010	4846874	AN460	5000814480	DG080	500391047	AY700
4610742	JE476	4757272	AN010	4846875	AN470	5000814481	DG082	500395171	CA5010
4616568	KV482	4757273	AX850	4851921	JC732	5000814482	DG082	500395172	FA5010
4616588	KV482	4757274	AY020	4852099	LA602	5000815434	NP067	500396535	AG9350
4628453	JM661	4757275	BD830	4854648	HBS011	5000839008	DL630	500397664	CA5600
4630672	KV477	4757276	AN340	4854653	JC874	5000839009	EZ182	500397665	FA5600
4632123	JE150	4759494	BP480	4856991	BV520	5001000786	NA784	5010240656	JJ546
4633735	LT987	4769441	BV520	4856992	BV710	5001000816	NA784	5010339723	NA5181
4640754	AN360	4769442	BV520	4862513	BH790	5001001215	HBS011	5010477117	AD5770
46432735	JD150	4769443	BP480	4862514	BH790	5001001216	HBS011	5012850	DC790
46527523	JD225	4769444	BP480	4862515	BH790	5001001254	NP067	5012851	DC800
4653286	AN460	477118	ET841	4864034	KV477	5001014264	EZ184	5013013	JM848
4653615	AN470	477119	ET841	4868470	BC550	5001825563	DL630	5013019	JN273
4654363	JN192	477327	ET841	4868475	AN360	5001825564	DG080	504007514	AG9360
465783	BT830	4776395	BH790	4868477	AL350	5001825565	DG082	504017372	JJ613
4658407	HBS427	4776544	JC732	4871982	JC873	5001825566	DG082	504028001	JH5071
4659146	AN360	477785	JJ474	490525	PB180	5001826447	EZ197	504031409	NF885
46608292	FN46A	4782504	JJ468	4928554	JA866	5001826448	EZ193	504034832	NF885
4670914	JE639	4782836	JN192	5000043840	BL600	5001826450	EL600	504059361	NF883
4673810	LR948	4785051	JJ475	5000044902	BF980	5001826451	DL602	504092108	KK5608
46757318	JD150	4789843	AN470	5000045766	JN260	5001826452	DL602	504092110	JD5350
4675733	BH790	479067	JJ473	5000133224	JN269	5001826453	EL601	504154280	JD5938
4675744	BH790	4790925	AN460	5000133662	BL600	5001826884	DG083	504287510	JH5169
4678902	BC550	4790926	BV520	5000246231	GF970	5001829815	AY590	5096250140	NJ232

OE reference	▲ Payen	OE reference	▲ Payen	OE reference	▲ Payen	OE reference	▲ Payen	OE reference	▲ Payen
5096250141	NJ232	51039010216	B6650	510E6C037A	CD490	5420140422	JH5073	5878100582	GK041
5096250150	NJ231	51039010227	B6650	510E6C037B	CD490	5420140622	JH5073	5878100583	GK041
5096250520	NJ232	51039010233	B6650	510E6C037C	CD490	550007	CG450	5878101670	GK043
5096250540	NJ231	51039010244	B6650	5111410040	BK040	5500079	CG450	5878101671	GK043
51.00900.6550	DV500	51039010245	B6650	5111410300	BK040	550008	CZ020	5878101672	GK043
51.00900.6558	DG855	51039010246	B6650	5111410570	BK040	550025	GB140	5878101673	GK043
51.00900.6570	DG650	51039010252	B6650	5111410830	BK040	550028	FZ030	5878101680	DK042
51.00900-6437	DG650	51039010260	BG070	5111730040	JN505	550099	DB140	5878101681	DK042
51.00900-6464	GG651	51039010262	B6650	5111730160	JN504	5500996	DB140	5878102182	GK042
51.00900-6602	EH5450	51039010268	B6650	5113670050	JJ177	5501507	CZ020	5881256	HJ271
51.01510.0151	NF754	51039010272	AH5440	5113670051	JJ177	550152	CZ030	5890739	DS381
51.03901.0297	AH5450	51039010273	AH5440	5113670410	JJ244	550180	FZ030	5891827	DE588
51.03905.0134	JN316	51039010285	AH5440	5113670630	JJ376	5501804	FZ030	5891972	DE588
51.04902.0028	PB224	51039010286	AH5440	5113670631	JJ376	550181	GB130	5892434	DE588
51.05904.0131	JJ489	51039010292	BV500	5113670640	JJ376	5501812	GB130	5893811	JC732
51.05904.0132	JJ495	51039010295	BV500	5113670641	JJ376	550182	CZ030	5894789	DS381
51.05904.0133	JJ489	51039010337	BV500	5113670720	JJ244	5501820	CZ030	590E6C037B	CD490
51.05904-0139	JJ490	51039010338	BG850	5125690010	PA208	550183	DB130	5930354	HC466
51.08901.0027	JD124	51039010342	BG650	5140139	JD5350	5501838	DB130	6 535 949	PB180
51.08902.0161	JD117	51039010346	BV500	5141150300	JC329	550184	GB140	6010100180	EM720
51009006204	DG071	51039010347	BV500	5141450040	JC336	5501846	GB140	6010103620	DW370
51009006256	DG640	51039010351	BV500	5141450041	JC336	550188	GB141	6010104805	EM720
51009006424	CH5440	51039010355	BL540	5141450042	JC336	5501887	GB141	6010104820	DW370
51009006522	GV500	51039010357	BV500	51900200275	HBS473	550214	DB140	6010140222	JJ498
51009006524	GV501	51039010379	BV500	51900200356	HBS473	5502141	DB140	6010160421	JN572
51009006527	DV500	51039050043	JN260	51900200383	HBS472	550227	GB131	6010160521	JN619
51009006530	GV500	51039050102	JM354	51900200403	HBS367	5502273	GB131	6010160621	JN572
51009006531	GV501	51039050127	JM354	51900200404	HBS367	5504567	HT017	6010160721	JN619
51009006532	GV502	51039050134	JN316	51904900070	HBS366	551404	GT570	6010162320	BW370
51009006534	DV500	51039050144	JN260	51904900071	HBS366	551415	CZ030	6010162520	BW370
51009006535	GG85A	51039050148	JM354	51965010357	HT019	5514153	CZ030	6010163320	BW370
51009006550	DV500	51049020027	HR775	51965010412	HT019	551416	FZ030	6011410280	JD158
51009006558	DG855	51049020028	PB224	541 010 52 20	DZ141	551426	CZ020	6011410580	JD158
51009006566	GV502	51059040083	JJ495	5410100205	EC330	551427	DB130	6011420280	JD159
51009006570	DG651	51059040132	JJ495	5410100505	EC521	551437	GB140	6020100080	EN720
51009006583	EG856	51059040133	JJ489	5410100921	DZ143	551438	HC475	6020104220	DW380
51009006603	EH5451	51059040171	JJ542	5410101120	DZ140	5514385	HC475	6020104320	DN722
51009006604	EV500	51089010023	JD156	5410140322	JH5018	551449	GT570	6020105505	EN720
51009006605	EV501	51089010087	JB848	5410140522	JH5072	5514492	GT570	6020106720	DW380
51015100133	NB966	51089020086	JD118	5410160320	BZ140	551450	HC474	6020107520	DW381
51015100145	NB928	51089020121	JD118	5410160321	JM5186	5514500	HC474	6020140322	JJ543
51015100150	NB928	51089020161	JD117	5410160421	JM5187	5514567	DB131	6020160121	JN621
51015100151	NF754	51089020170	JD118	5410160520	BZ140	551459	GB131	6020160221	JN622
51015100152	NB964	510E6008D	FD491	5410161020	BZ140	551469	DB140	6020160321	JN621
51015100153	NB929	510E6008E	FD491	5410161120	BZ140	5514690	DB140	6020160420	BN720
51015100163	NB964	510E6008F	FD491	5410161320	DZ143	551470	GB141	6020162220	BW380
51015100172	NB967	510E6008K	FD491	5410161520	AG8280	551484	DT570	6020162320	BW380
51015100196	NB966	510E6008L	FD491	5410980280	JD5086	5514849	DT570	6020162420	BW380
51015100197	NB928	510E6008M	FD491	5410980380	JD5086	551512	DS561	6020162620	BN720
51015100206	NB966	510E6008T	FD491	5410980480	JD5086	551513	DS560	6020163020	BN720
51015100218	NA5181	510E6008U	FD491	5411420180	JA5077	551516	GB131	6020163120	BN720
51015100219	NA5156	510E6008V	FD491	5419900501	HBS350	5878100220	GK041	6020163520	BW380
51015100237	NB967	510E6051B	AD490	542 010 04 05	EC522	5878100221	GK041	6020163920	BW380
51015106002	NB928	510E6051E	AD490	5420100205	EC370	5878100222	GK041	6020500058	HR758
51015106004	NB928	510E6362	NA748	5420140122	JH5073	5878100580	GK041	6021410080	JD299
51029505155	JN260	510E6362B	NA748	5420140322	JH5168	5878100581	GK041	6021410280	JD298

INTERCHANGE OE → PAYEN

Vergleichsliste OE → Payen • Références croisées 1ère Monte → Payen
Intercambio OE → Payen • Intercambio entre equipo original y Payen

OE reference	▲ Payen	OE reference	▲ Payen	OE reference	▲ Payen	OE reference	▲ Payen	OE reference	▲ Payen
6021410680	JD298	61321115	PB047	61687325	HC433	763F6008HAA	GD600	826F6385AAB	KT638
6021410780	JD298	6134416	JN594	6170100380	EC791	763F6014FAA	DD600	826F6584DAA	JN387
6021410880	JD298	6134949	GL780	6170101105	EC791	763F6014GAA	DD600	826F6584EAA	JN388
6021420080	JD299	6134958	DL780	6170160180	JN273	763F6014HAA	DD600	826F6700D1B	NB688
6039900110	HBS058	6134963	KT638	6170160680	BC800	763F6051GBB	BD600	826F6701DAB	KT638
6039900210	HBS058	6139764	BN500	6170160720	BC800	7700853324	HBS011	826F6781AA	HC056
6039900310	HBS058	6147047	PB180	6170160820	BC800	7701031953	JN594	826F6781CA	HC057
6040140022	JJ498	6150160080	JM848	6171420780	JD297	7701034967	JC054	82875	CE203
6050140022	JJ543	6150162020	BG990	6175860390	DC800	7701035740	NP067	833347	HR801
6050140122	JJ543	6151420580	JB162	6175915	NB984	7701040490	AB5110	8544659	JE479
60507653	JF123	6151420780	JB162	622708540054	AH5420	7701041926	NF883	86TM6571AA	PB180
60535949	HR801	61576216	HT028	62270854006	AH5420	7701042340	NP067	86TM6571AB	HR801
6062634	NA5101	61576217	HT027	622708540064	AH5420	7701043299	NP068	8804253	AX070
6062635	NB688	61576218	HT026	622808530064	JH5172	7701044092	NF883	8807692	KK972
6102562	JN387	61581378	JC267	630508530164	JH5172	7701044093	NF885	8807693	PA159
6102563	JN388	61583935	JC268	6393739	BL150	7701044224	BX390	8807694	KK180
6103811	BL780	61584021	JC458	6470140022	JJ543	7701044225	BX400	8808493	KK195
6103812	BN500	61584262	JC268	6535949	HR801	7701044226	BX410	8808494	KL351
6103813	BN510	61584371	BR390	656590	BN660	7701203212	DS381	8808495	KK196
6104215	GL780	61584473	JN893	681404	DN663	7701204563	DE588	88089010206	JB897
6104216	GN500	61584574	JC267	682670	DN660	7701204926	DE588	8814911	JM667
6104218	GN510	61584666	BR390	682685	EX030	7701404452	HR397	8816531	JM666
6104220	GN510	61585206	JC458	683F6008AA	GD600	7701461929	NB946	8817862	HC331
6104227	DL780	61585237	AY370	683F6008DAA	GE960	7701461930	NP067	8818398	HC083
6104236	HC056	61585255	JC267	683F6014AA	DD600	7701465195	DL992	8818558	AN010
6104238	HC057	61585264	JC267	683F6014DAA	DE960	7761598	JD225	8818605	AN340
6105490	KT638	61585438	JJ190	683F6701AA	KT638	7765227	JD225	8818915	HC428
611 010 01 74	NA5074	61585680	HT029	693F6008GAA	FV670	7766037	JD150	8820866	HC397
6110100114	NA5074	61585681	HT030	693F6008HAA	FV670	77BM6571AB	PB180	8824255	HC397
6110140222	JH5082	61585712	BR390	693F6701AAA	KT638	783F6700AA1A	NA5101	8824633	AX850
61315063	JS075	61585946	BR390	703F6008AAA	GE960	783F6700AAA	NB688	8829095	JN312
61315083	PB047	61586092	JC267	703F6008EAA	FV670	793F6701AAA	KT638	8829321	JN222
61315094	JN745	61586153	AY370	703F6014AAA	DE960	8090960	GV715	8940326720	JJ376
61315681	JN745	61586446	BR390	703F6014BAA	DD600	8096541	AY690	8940326730	JJ376
6131594	JN745	61586448	BR390	703F6051AA	BE960	8096619	JR580	8941458390	BK040
61316600	JJ406	61586449	AY370	7048712	NB984	8096682	JC055	8941592610	JC336
61316613	BS350	61589036	JA893	71713695	DX391	8096910	BX410	8966010	FN01B
61316747	HT031	61589037	JA894	71713696	GX410	8096911	AY590	8996010	FN01B
61316748	HT032	6159900112	HBS045	71713987	CY680	8096930	DX391	89FF6700A2A	NB984
61316749	HT033	6159900212	HBS045	71728337	GX410	8097075	BX420	89FF6710BA	JJ456
61316793	HT034	6159900312	HBS045	723F9448HAA	JA468	8097366	LC280	901040	FL581
61317233	JC267	6160100380	EC790	723F9A457HAA	JA468	8097421	CY680	901919	FL35D
61317796	KD930	6160105221	GC790	73001262	NP068	813948	DS980	90328	FL611
61318325	JJ406	6160105506	EC790	7300877	JC055	813949	EG140	9040101921	CC5931
61319042	JS077	6160140122	JH683	7301198	NP067	826F6008AA	GL780	9040102220	CC5930
61319043	JS078	6160160920	BC790	7301262	NP068	826F6008AB	GL780	9040104505	EC5850
61319052	KK5608	6160161220	BC790	7302293	JN594	826F6008BA	GN500	9040160421	JM5075
61319053	JN745	6160161420	BC790	735232M91	EE204	826F6008DA	GN510	9040161020	AC5931
61319083	JJ191	6160161520	BC790	753F6D000AA	BE960	826F6008FA	GN510	9040161120	AC5931
61319085	BS350	6160162020	BC790	753F6D000BA	BD600	826F6014AA	DL780	9060100321	CC5840
61319208	JC268	6165860390	GC790	753F6D000CA	BE960	826F6014AB	DL780	9060103720	CC5840
61319394	JN745	6165860490	DC790	753F6D000DA	BD600	826F6051DAA	BL780	9060104505	EC5840
61320224	JJ406	6165860990	DC790	753F6D000DB	BD600	826F6051FAA	BN510	9060105521	CC5841
61320638	BR390	6165861290	DC790	76043876	AX850	826F6051H1A	BN510	9060106020	CC5840
61320639	AY370	61687174	JJ191	763F6008FAA	GD600	826F6051H2A	BN510	9060108720	CC5840
61321089	JC267	61687175	JJ191	763F6008GAA	GD600	826F6385AAA	KT638	9060160420	AC5841

OE reference	▲ Payen	OE reference	▲ Payen	OE reference	▲ Payen	OE reference	▲ Payen	OE reference	▲ Payen
9060160421	JM5172	98427452	JJ416	98481293	HC397	99488483	JJ519	CFPN6008C	DS990
9060160720	AC5841	98427996	NB946	98484659	KD931	99488486	JJ533	CFPN6A008A	EG140
9060160769	HBS351	98427998	NP067	98489690	JD229	996562	AL330	CFPN6A008B	EG140
9060161120	AC5841	98428409	NP068	98492150	DS381	A850X6014CNA	DC790	CFPN6A008C	EG160
9060161220	AC5841	98430478	KD929	98493262	JJ518	A850X6014CRA	DC800	DONN6710B	JJ121
9060530358	HR801	98431960	AN460	98493305	JA866	A850X6584BGA	JM848	DONN6710D	JH420
9061410180	JD5283	98431961	BV520	98493460	AX070	A850X6584BNA	JN273	D3NN6051E	BJ040
9061420280	JE5035	98431962	BP480	98493462	AN340	ABU8751	DE960	D3NN6051F	BE740
9099243270	NJ233	98431963	AN470	98493464	AN010	ABU8752	HC056	D5NN6700A	NA764
9099243280	NJ233	98431964	BV710	98494599	BD830	ABU8754	HC057	D5NN6701A	NA965
9099243560	NJ596	98433204	JJ593	98495010	JA5009	ABU8755	DD600	D8NN6051AA	BS980
9099244330	NJ232	98433292	KD5002	98497505	BW120	ABU8756	CH940	DNN6051F	DE740
9099245060	NJ233	98434020	JC055	98499587	AX850	ABU8757	EF031	DONN6710B	JJ121
9099245070	NJ231	98435149	BW120	9899707660	BJ260	ABU8763	EC220	DONN6710D	JH420
9099245500	NJ233	98436180	JD584	99425767	JC054	ABU8778	EG700	EONN6051FA	BE740
9099245580	NJ233	98443190	BV710	9942588	JP069	ABU8780	EG692	E138Z9	CD510
9102171	NA736	98443191	BW160	99430005	BX390	ABU8864	CS412	E140Z5	CD490
91034705	AH870	98443194	BV520	99432353	BX400	ABU8870	CG450	E1ADDN6008AB	FD511
91065314	BL150	98443195	BS340	99432354	BX390	ABU8872	CZ020	E1ADDN6008AC	FD511
91065315	BL160	98445099	AB5110	99432807	LC281	ABU8874	DB140	E1ADDN6008AD	FD511
91075538	DL160	98446492	JJ533	99432808	LC282	ABU8875	GB140	E1ADDN6008AK	FD512
91075539	DL160	9844828	AN460	99433965	NP067	ABU8876	DE220	E1ADDN6008AM	FD512
91079782	AH940	98448285	BV520	99435413	BV520	ABU8877	EE220	E1ADDN6008B	FD511
91079783	AH870	98448286	BV710	99435433	BS340	ABU8878	DE230	E1ADDN6051C	AD510
91093358	CH871	98448288	AN460	99435439	BV710	ABU8879	EE230	E1ADDN6051E	AD510
9111416840	BJ260	98448289	AN470	99435440	BW160	ABU8880	EE240	E1ADDN6C037C	CD510
9111416841	BJ260	98448533	BV520	99435791	BW151	ABU8881	DE240	E1ADDN6C6051C	CD510
9125690550	PA977	98448534	BS340	99440116	JE5005	ABU8883	DG853	E1ADKN6051B	AD510
9125690551	PA977	98448536	BW160	99440847	KD5001	AJR4005	KT633	E1ADKN6701A	KT638
922908540144	AG7340	98448537	BV710	99442636	AN460	BBU6343	F2030	E232Z9	CD510
93FF6700AA	NB984	98448817	AB5110	99442637	AN470	BBU6344	C2030	E234Z5	CD490
94032672	JJ376	98449318	JN222	9944352	DS381	BBU6345	DB130	E235Z5	CD490
94032673	JJ376	98451055	NP068	99443902	JH5001	C47E6700A	NA764	E3NN6701BA	NA965
94037668	NJ937	98453649	HC480	99444980	JC874	C47Z6700A	NA764	E3NN670BA	NA965
94051171	NJ790	98453651	HC480	99446692	JM5004	C4TZ6700A	NA764	E5NN6584BD	JM541
94051172	NJ791	98454039	NP067	99447458	NF883	C5NE6051F	BJ050	E5NN670BA	NA965
94145839	BK040	98454041	NP067	99453418	NF883	C5NE6051H	BJ060	E7NN6051DA	BJ040
94159261	JC336	98454045	NP067	99455400	HL5004	C5NE6051J	BJ060	E8NN6051AA	BS980
957E6008A	CE203	98455718	HC480	99456553	HL5003	C5NE6051K	BE740	E8NN6051BA	BS990
957E6051B	AE200	98456215	BV520	99456733	LA602	C5NE6571A	KG485	E8NN6051M	BS980
957E6584	JM348	98456216	BS340	99458402	BX420	C5NE6700A	NA764	EAPN6A008A	EG140
957E6701	KT633	98456218	BW160	99460983	BX410	C5NE6701A	JH420	F1NN6051BA	BX540
957E6C037	CE203	98456219	BV710	99461498	AY580	C5NE6701C	NA965	L681EF06	AE200
960E6051	AE200	98457859	HC480	99461499	AY590	C5NE6701C2	NA965	ME020231	BJ990
96353096	JM5172	98461673	NF885	99462588	JP069	C5NE6710A	JH420	ME021960	JJ242
968677	AL330	98471333	LC280	99465715	BY401	C5NN6700A	NA764	ME022821	BJ990
968689	JA849	98472008	AN460	99468744	NF883	C7NN6051D	BJ050	ME023152	NJ497
98400776	KA499	98472010	AN470	99469051	JH5062	C7NN6051E	BJ060	ME023491	NJ257
98400791	JD5350	98472012	BP480	99469244	JH5071	C7NN6051R	BJ050	ME024108	PA525
98410475	AB5100	98472024	AN460	99474208	AA5010	C7NN6051S	BJ060	ME024156	NJ258
98410476	AY590	98472025	AN470	99477116	GX410	C7NN6584B	JM540	ME030856	NJ910
98420446	JN796	9847212	BP480	99477119	DX391	C7NN6584C	JM541	ME030913	BS040
98420754	LA646	98472291	JN956	99481357	AN460	C9NN6701D	JH420	ME030932	JN429
98421263	JR580	98480127	JN796	99482736	LC280	C9NN6710D	JH420	ME031026	JN429
98421297	LA190	98481105	JN310	99486696	AY650	CFPN6008A	DJ040	ME031051	NJ496
98425767	JC054	98481292	HC083	99487487	GX410	CFPN6008B	DJ040	ME031489	BK560

INTERCHANGE OE → PAYEN

Vergleichsliste OE → Payen • Références croisées 1ère Monte → Payen
Intercambio OE → Payen • Intercambio entre equipo original y Payen

OE reference	▲ Payen®	OE reference	▲ Payen®	OE reference	▲ Payen®	OE reference	▲ Payen®	OE reference	▲ Payen®
ME031521	BK560								
ME031543	NJ496								
ME031548	NJ497								
ME031584	NJ257								
ME031858	BK560								
ME031859	BS040								
ME031916	BK560								
ME033008	JC321								
ME033276	JC321								
ME033401	JC321								
ME033496	JC808								
ME034003	JJ178								
ME035128	PA525								
ME038091	GK890								
ME038521	GK560								
ME038521HS	DK560								
ME038596	GK560								
ME041113	BS040								
ME051132	BS640								
ME999038HS	DK562								
ME999219	GS040								
ME999371	GS641								
MH034027	NJ258								
MIDR063540	EZ184								
MIDS063540	DL630								
OM351A	FS414								
OM400	HT020								
OM420	HT021								
OM440	HT021								
OM501	HT5038								
OM502	HT5038								
SSDJ480	DR555								
SSDJ481	DR556								
SSDJ482	DR557								
SSDJ483	DR558								
U5LB0012	EE204								
U5LT0012	CE203								
W81SM6571A2C	PB180								

TECHNICAL NOTES

Technische Hinweise • Notes techniques
Note tecniche • Notas técnicas



1	Shape: Seal	Form: Dichtring	Forme: Bague	Forma: Anello di tenuta
2	Aluminium	Ventildeckel: Aluminium	Aluminium	Alluminio
3	Steel	Ventildeckel: Stahl	Acier	Acciaio
4	Rocker cover pressed steel	Zylinderkopphaube aus Stahlblech	Couvre culasse en acier	Coperchio punterie in acciaio
5	Rocker cover aluminium	Zylinderkopphaube aus Aluminium	Couvre culasse en aluminium	Coperchio punterie in alluminio
6	With JN462 and JN594	Mit JN462 und JN594	Avec JN462 et JN594	Contiene JN462 e JN594
7	Without crankshaft seal	Ergänzungsartikel / Ergänzende Info:Ohne Wellendichtring für die Kurbelwelle	Sans bague d'étanchéité de vilebrequin	Articolo complementare/Info integrativa: senza paraolio-albero a gomito
8	Bolt Kit, cylinder head	Zylinderkopfschraubensatz	Jeu de vis de culasse de cylindre	Kit bulloni testata
9	2 Locating holes of 13mm	Markierungskerbe 13mm	2 trous de positionnement 13mm	2 Fori Centraggio 13mm
10	Gasket, water pump	Wasserpumpendichtung	Joint de pompe à eau	Guarnizione pompa acqua
11	Gasket, timing case	Steuergehäusedichtung	Joint de carter de distribution	Guarnizione carter della distribuzione
12	Locating hole 13mm	Markierungskerbe 13mm	Trou de positionnement 13mm	Fori di centraggio 13mm
13	Gasket Set, manual transmission	Dichtungssatz, Schaltgetriebe	Jeu de joints d'étanchéité, boîte de vitesse manuelle	Kit guarnizioni, Cambio manuale
14	O-Ring Set, cylinder sleeve	Dichtungssatz, Zylinderlaufbüchse	Jeu de joints d'étanchéité, chemise de cylindre	Kit guarnizioni, Canna cilindro
15	Bimetallic	Bimetallisch	Bi-métallique	Bimetallica
16	Includes 8 cylinder head gaskets	Enthält 8 Zylinderkopfdichtungen	Inclus 8 joints de culasse	Contiene 8 guarnizioni testa
17	For engines with rope seals	Für Motoren mit Dichtschnurabdichtung	Pour moteurs avec joints en corde	Per motori con tenuta a fune
18	Rope seal	Dichtschnurr	Joint corde	Guarnizione tenuta a corda
19	Includes JN594 + JN956	Beinhaltet JN594 + JN956	JN594 + JN956 inclus	Include JN594 + JN956
20	Sealant	Abdichtungsmaterial	Pâte à joints	Sigillante
21	Alternative material	Alternativmaterial	Matériau optionnel	Materiale alternativo
22	For vehicles without ride height adjustment	Fahrzeugausstattung: Für Fahrzeuge ohne Niveauregulierung	Pour véhicule sans réglage de niveau	Per veicoli senza imp. correzione altezza
23	For vehicles with ride height adjustment	Fahrzeugausstattung: Für Fahrzeuge mit Niveauregulierung	Pour véhicule avec réglage de niveau	Per veicoli con impianto correzione altezza
24	Integrated seal & housing	Dichtungsring im Gehäuse integriert	Plaque avant avec bague intégrée	Paraolio con alloggiamento
25	With cylindrical fit	Mit zylindrischer Passform	Avec montage cylindrique	Accoppiamento cilindrico
26	With taper fit	Mit kegeliger Passform	Avec tenon court	Accoppiamento conico
27	Without oil pan gasket	Ergänzungsartikel / Ergänzende Info 2:Ohne Ölwanndichtung	Sans joint de carter d'huile	Senza guarnizione coppa olio
28	Cast Aluminium	Zylinderkopphaubenmaterial: Aluguß	Aluminium moulé	Coperchio testa cilindri in alluminio
29	Synthetic Material	Zylinderkopphaubenmaterial: Kunststoff	Matières synthétiques	Materiale sintetico
30	Oil Pan Material: Cast Steel	Ölwannenmaterial: Stahlguß	Pour carter d'huile en fonte: acier	Materiale coppa olio: Acciaio fuso
31	Oil Pan Material: Cast Aluminium	Ölwannenmaterial: Aluguß	Pour carter d'huile en fonte: aluminium	Materiale coppa olio: Alluminio fuso
32	Oil Pan Material: Steel	Ölwannenmaterial: Stahl	Pour carter d'huile en acier	Materiale coppa olio: Acciaio
33	Tappet Cover Material: Synthetic Material	Zylinderkopphaubenmaterial: Kunststoff	Matières synthétiques	Coperchio punterie in materiale sintetico
34	Tappet Cover Material: Aluminium	Zylinderkopphaubenmaterial: Aluguß	Aluminium moulé	Coperchio punterie in alluminio
35	Height 2 [mm]: 13	Höhe 2 [mm]: 13	Hauteur 2 [mm]: 13	Altezza 2 [mm]: 13
36	With cylinder sleeve ring	Mit Zylinderlaufbüchsenring	Avec deux joints de chemise de cylindre	Con anello tenuta canna cilindro
37	Without JH5002	Ohne JH5002	JH5002 non inclus	Senza JH5002
38	For 3 cylinder	für 3 Zylinder	pour cylindre: 3	Per 3 cilindri
39	Metal	Metall	Métal	Metallo
40	For 2 cylinder	für 2 Zylinder	pour cylindre: 2	Per 2 cilindri
41	For 1 cylinder	für 1 Zylinder	pour cylindre: 1	Per 1 cilindro
42	For 6 cylinder	für 6 Zylinder	pour cylindre: 6	Per 6 cilindri
43	Diameter 1 [mm]: 2,00	Durchmesser 1 [mm]: 2,00	Diamètre 1 [mm]: 2,00	Diametro 1 [mm]: 2,00



1	Forma: Anillo obturador	Kształt: Pierscień uszczelniający	Форма: Уплотнение	الشكل: مانع تسرب
2	Aluminio	Aluminium	Алюминий	مادة وعاء الزيت: ألومنيوم
3	Acero	Stal	Сталь	مادة وعاء الزيت: الصلب
4	Tapa de balancines de acero prensado	Pokrywa rozrządu tłoczona ze stali	Покрытие рокера из листовой стали	غطاء الأذرع المتأرجحة المصنوع من الصلب المضغوط
5	Tapa de balancines de aluminio	Pokrywa rozrządu aluminiowa	Покрытие рокера из алюминия	غطاء الأذرع المتأرجحة المصنوع من الألومنيوم
6	Con JN462 y JN594	Z JN462 i JN594	C JN462 i JN594	مع JN462 و JN594
7	Sin retén de cigüeñal	Bez uszczelnienia wału korbowego	Без уплотнения коленвала	مادة تكميلية/معلومات تكميلية: بدون مانع تسرب عمود المرفق
8	Juego de tornillos de culata	Zestaw śrub głowicy cylindrow	Набор болтов ГБЦ	طقم المسامير، رأس الأسطوانة
9	2 muescas de ubicación de 13mm	2 otwory pozycjonujące 13 mm	2 установочных отверстия 13 мм	فتحتا تحديد موقع سعة 13 ملم
10	Junta, bomba de agua	Uszczelka, pompa wodna	Прокладка, водяной насос	حشية، مضخة ماء
11	Junta de cárter de distribución	Uszczelka, obudowa rozrządu	Прокладка, корпус газораспределительного механизма	حشية، جوان كارتر الكتيه
12	Muesca de ubicación 13mm	Otwór pozycjonujący 13 mm	Установочное отверстие 13 мм	فتحة تحديد موقع سعة 13 ملم
13	Juego de juntas, caja de cambios	Zestaw uszczelkeł, mechaniczna skrzynia biegów	Комплект прокладок, механическая коробка передач	مجموعة حشية، ناقل حركة يدوي
14	Juego de juntas, bombín	Zestaw o-ringów, tuleja cylindrowa	Комплект кольцевых уплотнений, гильза цилиндра	مجموعة حشية، ناقل حركة يدوي مجموعة حلقة دائرية، كم الأسطوانة
15	Bimetálico	Bimetalowy	Биметаллический	ثنائي المعدن
16	Incluye 8 juntas de culata	Zawiera 8 uszczelkeł głowicowych	Включает в себя 8 прокладок ГБЦ	تتضمن 8 حشيات لروس الأسطوانات
17	Motores retén 'rope'	Do silników z uszczelnieniem sznurowym	Для двигателей с сальниковой набивкой	للمحركات المزودة بموانع تسرب حبلية
18	Junta 'rope'	Uszczelnienie sznurowe	Сальниковая набивка	مانع تسرب حبلي
19	Incluye JN594 + JN956	Zawiera JN594 + JN956	Включает JN594 + JN956	يتضمن JN594 + JN956
20	Sellante	Uszczelniacz	Герметик	مانع تسرب
21	Material alternativo	Materiał alternatywny	Альтернативный материал	مادة بديلة
22	Para vehículos sin regulación de nivel de altura	Do samochodów bez regulacji wysokości zawieszenia	Для автомобилей без регулировки высоты подвески	معدة المركبة: للمركبات التي لا يمكن ضبط ارتفاع الركوب بها
23	Para vehículos con regulación de nivel de altura	Dla samochodów z regulacją prześwitu podwozia	Оборудование автомобиля: для автомобилей с регулировкой высоты подвески	معدة المركبة: للمركبات التي لا يمكن ضبط ارتفاع الركوب بها
24	Retén de Carcasa	Zintegrowane uszczelnienie i obudowa	Уплотнение интегрированное в корпус	أختام متكاملة و قالب
25	Con montaje cilíndrico	Z połączeniem cylindrycznym	С цилиндрической посадкой	بتركيبية أسطوانية
26	Con montaje de cinta	Z połączeniem stożkowym	С конусной посадкой	بتركيبية مستدقة
27	Sin junta de cárter de aceite	Bez uszczelki miski olejowej	без прокладки поддона картера	مادة تكميلية/معلومات تكميلية 2: بدون حشية وعاء الزيت
28	Material culata: aluminio	Odlwane aluminium	Литой алюминий	الألومنيوم المصبوب
29	Plástico	Materiał syntetyczny	Синтетический материал	مادة غطاء غاز: مادة صناعية
30	Material cárter: Acero fundido	Materiał miski olejowej: odlew stalowy	Материал масляного поддона: литая сталь	مادة وعاء الزيت: الصلب المصبوب
31	Material cárter: Aluminio fundido	Materiał miski olejowej: odlwane aluminium	Материал масляного поддона: Литой алюминий	مادة وعاء الزيت: الألومنيوم المصبوب
32	Material cárter: Acero	Materiał miski olejowej: stal	Материал масляного поддона: сталь	مادة وعاء الزيت: الصلب
33	Material de la tapa de balancines: Plástico	Materiał pokrywy rozrządu: materiał syntetyczny	Материал толкателя клапана: синтетический материал	تشتمل المواد: المواد الاصطناعية
34	Material de la tapa de balancines: Aluminio	Materiał pokrywy rozrządu: aluminium	Материал толкателя клапана: алюминий	تشتمل المواد: الألومنيوم
35	Altura 2 [mm]: 13	Wysokość 2 [mm]: 13	Высота 2 [мм]: 13	الارتفاع 2 [ملم]: 13
36	Con segmentos para camisa	Zawiera pierścień tulei cylindrowej	С кольцом гильзы цилиндра	أسطوانة جلبية مع حلقة
37	Excluido JH5002	Bez JH5002	Без JH5002	بدون JH5002
38	para cilindro: 3	Dla 3 cylindrowy	Для цилиндров: 3	ثلاث أسطوانات
39	Metal	Metal	Метал	المعدن
40	para cilindro: 2	Dla 2 cylindrowy	Для цилиндров: 2	لأسطوانتين
41	para cilindro: 1	Dla 1 cylindrowy	Для цилиндров: 1	لأسطوانة واحدة
42	para cilindro: 6	Dla 6 cylindrowy	Для цилиндров: 6	لست أسطوانات
43	Diámetro 1 [mm]: 2,00	Średnica 1 [mm]: 2,00	Диаметр 1 [мм]: 2,00	قطر 1 [مم]: 2.00

TECHNICAL NOTES

Technische Hinweise • Notes techniques
Note tecniche • Notas técnicas



44	Diameter 1 [mm]: 3,75	Durchmesser 1 [mm]: 3,75	Diamètre 1 [mm]: 3,75	Diametro 1 [mm]: 3,75
45	Cylinder head assembly, contains one steel plate plus rubber seal rings	Zylinderkopf-Dichtungssatz enthält Stahlplatte und Gummidichtungsringe	Assemblage de culasse, comprenant plaque acier et rondelles d'étanchéité caoutchouc	Montaggio testa cilindro, contiene piastra in acciaio con anelli in gomma per tenuta
46	Includes BE950	Beinhaltet BE950	BE950 inclus	Contiene BE950
47	Includes BV270	Beinhaltet BV270	BV270 inclus	Contiene BV270
48	Steel laminated sumps only	Nur für laminierte Ölsümpfe	Seulement pour carter en acier laminé	Solo per carter in acciaio laminato
49	Gasket, thermostat housing	Dichtung für Thermostatgehäuse	Joint, boîtier de thermostat	Guarnizione sede termostato
50	Gasket, thermostat	Thermostatdichtung	Joint de thermostat	Guarnizione termostato
51	Gasket, charger	Turboladerdichtung	Joint de turbocompresseur	Guarnizione turbo
52	Charge Type: Naturally Aspirated Engine	Aufladungsart: Sauger	Moteur aspiration naturelle	Motore aspirato
53	Seal, oil pump	Ölpumpen-Wellendichtring	Joint de pompe à huile	Guarnizione coppa olio
54	Charge Type: Turbo Intercooler	Aufladungsart: Ladeluftgekühlter Turbo	Turbo/refroidissement d'air de suralimentation	Turbo / Intercooler
55	Seal	Wellendichtring	Bague	Guarnizione
56	Shaft Seal, manual transmission	Wellendichtring, Schaltgetriebe	Bague d'étanchéité, boîte de vitesse manuel	Paraolio, Cambio velocità manuale
57	Gasket, timing case cover	Steuergehäusedeckeldichtung	Joint de carter de distribution	Guarnizione copricatena distribuzione
58	Seal, coolant pipe	Dichtring, Kühlmittelrohrleitung	Bague d'étanchéité, conduite de réfrigérant	Anello tenuta, Condorrio raffreddamento
59	With 1/2" cylinder head studs	Mit 1/2"-Zylinderkopfschrauben	poignon de couvre-culbuteur 6,5mm	Con viti testa cilindro da 1/2"
60	With 9/16" cylinder head studs	Mit 9/16"-Zylinderkopfschrauben	Poignon de couvre-culbuteur 8,5mm	Con viti testa cilindro da 9/16"
61	Single Layer Steel	Einlagige Stahl-Zylinderkopfdichtung	Feuille simple acier	In acciaio monostrato
62	Vertical engines only	Nur für Motoren mit vertikaler Einbaulage	Seulement pour moteur vertical	Solamente per motori verticali
63	For engines with lip seals	Für Motoren mit Lippendichtung	Seulement pour moteur avec bagues à lèvre	Per motori con paraoli a labbro
64	Horizontal engines only	Nur für Motoren mit horizontaler Einbaulage	Seulement pour moteur horizontal	Solamente per motori orizzontali
65	For vertical engines only	Nur für Motoren mit vertikaler Einbaulage	Seulement pour moteur vertical	Solamente per motori verticali
66	For intake valves	Für Einlassventile	Pour valves d'admission	valvole aspirazione
67	Set does not include crankshaft front or rear oil seals	Satz enthält keine Dichtringe für die Kurbelwelle	Pochette n'inclut pas les bagues AV ou AR de vilebrequin	la serie non contiene paraoli anteriore e posteriore albero motore
68	Oil seal, wheel hub	Radnaben-Dichtring	Bague d'étanchéité, moyeu de roue	Paraolio mozzo ruota
69	Set does not contain crankshaft front oil seals	Satz enthält keinen vorderen Dichtring für die Kurbelwelle	Pochette n'inclut pas les bagues avant de vilebrequin	la serie non contiene paraolio anteriore albero motore
70	Cylinder liner seals/gaskets included	Zylinderlaufbüchsen-Abdichtungen/Dichtungen enthalten	Joints de chemise / joints inclus	Guarnizioni anelli tenuta canna inclusi

				
44	Diámetro 1 [mm]: 3,75	Średnica 1 [mm]: 3,75	Диаметр 1 [мм]: 3,75	قطر 1 [مم] : 3.75
45	Montaje de culata, contiene una placa metálica mas juntas tóricas	Zestaw montażowy głowicy, zawiera jedną podkładkę stalową plus gumowe pierścienie uszczelniające	Набор ГБЦ, содержит стальной лист и резиновые кольца уплотнений	مجموعة رأس الأسطوانة، تتضمن لوحة واحدة من الصلب وجوانات مطاطية
46	Incluye BE950	Zawiera BE950	Включает BE950	يتضمن BE950
47	Incluye BV270	Zawiera BV270	Включает BV270	يتضمن BV270
48	Solamente para cárter de acero laminado.	Tylko laminowane stalowe miski olejowe	Только для стальных поддонов	أحواض مصنوعة من رقائق الصلب فقط
49	Junta, alojamiento del termostato	Uszczelka, korpus termostatu	Прокладка, корпус термостата	حشية ، قالب ترموستات
50	Junta, termostato	Uszczelka, termostat	Прокладка, термостат	حشية ، ترموستات
51	Junta de compresor	Uszczelka, sprężarka dotadowująca	Прокладка, нагнетатель	جوان التبريد
52	Motor de aspiración	Silnik wolnossący/bez dotadowania	Атмосферный двигатель	محرك ينضخ طبيعي
53	Anillo de retención	Uszczelnienie, pompa oleju	Сальник, масляный насос	حشية، مضخة زيت
54	Intercooler/turbo	Turbo Intercooler	Промежуточный охладитель турбонаддува	توربو المبرد
55	Junta	Uszczelnienie	Уплотнение	ختم
56	Anillo retén, caja de cambios	Uszczelnienie wału, skrzynia biegów mechaniczna	Сальник вала, ручная коробка передач	ختم عمود , ناقل الحركة اليدوي
57	Junta de la tapa del cárter de distribución	Uszczelka, pokrywa obudowy rozrządu	Прокладка, корпус газораспределительного механизма	حشية، جوان غطا كارتير الكتينه
58	Junta anular, tubería refrigerante	Uszczelnienie, przewód cieczy chłodzącej	Уплотнение, трубка системы охлаждения	الختم ، أنبوب التبريد
59	Con remaches de 1/2" de junta de culata	Ze śrubami głowicowymi 1/2"	С длиной шпилек головки блока 1/2 дюйма	مع 1 / 2 "مسامير رأس الأسطوانات
60	Con remaches de 9/16" de junta de culata	Ze śrubami głowicowymi 9/16"	С длиной шпилек головки блока 9/16 дюйма	مع 9 / 16 "مسامير رأس الأسطوانات
61	Metálica monocapa	Pojedyncza warstwa stalowa	Однослойное стальное уплотнение	طبقة واحدة الصلب
62	Sólo motores verticales	Tylko silniki pionowe	Только двигатели вертикального расположения	للمحركات العمودية فقط
63	Para motores con retenes de labio	Dla silników z uszczelnieniami wargowymi	Для двигателей с уплотнением по кромке	للمحركات مع الأختام الشفة
64	Sólo motore horizontales	Tylko silniki poziome	Только для двигателей горизонтального расположения	للمحركات الأفقية فقط
65	Para motores verticales solamente	Tylko dla silników pionowych	Только для двигателей вертикального расположения	للمحركات العمودية فقط
66	Para válvulas de admision	Dla zaworów dolotowych	Для впускных клапанов	لصمامات السحب
67	El kit no incluye los retenes delanteros o traseros del cigüeñal	Zestaw nie zawiera przednich lub tylnych uszczelnień olejowych wału korbowego	Комплект не содержит передних или задних сальников коленвала	مجموعة لا تتضمن سداد للزيوت الأمامي أو الخلفي للعمود المرفقي
68	Retén, cubo de rueda	Uszczelnienie olejowe, piasta kota	Сальник, ступица колеса	ختم النفط، محور العجلة
69	El kit no incluye los retenes delanteros del cigüeñal	Zestaw nie zawiera przednich uszczelnień olejowych wału korbowego	Комплект не содержит передних сальников коленвала	مجموعة لا تحتوي على سداد للزيوت الأمامي للعمود المرفقي
70	Incluidas las juntas/retenes de la camisa	Zawiera uszczelki/uszczelnienia tulei cylindrowej	Уплотнения гильзы цилиндра/прокладки включены	تشمل جوانات الأختام بطانة اسطوانة

A NEW LOOK FOR THE SEALING EXPERT

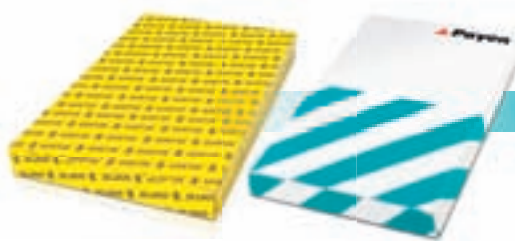

CURRENT

NEW

Federal-Mogul Global Aftermarket EMEA bvba

Kontichsesteenweg 67/1 • B-2630 Aartselaar • Belgium
Phone +32 (0)3 450 83 10 • Fax +32 (0)3 450 83 38

Central Distribution Centre

Prins Boudewijnlaan 7 • B-2550 Kontich • Belgium
Phone +32 (0) 3450 83 10 • Fax +32 (0) 3450 83 38



**Federal-Mogul Italy Srl
Aftermarket Division**

Via Enrico Fermi 8 • 37135 Verona • Italy
Phone +39 045 828 13 11 • Fax +39 045 828 14 00



Federal-Mogul Friction Products GmbH

Federal-Mogul Aftermarket

Klosterstraße 16 • D-51709 Marienheide • Germany
Phone +49 (0) 2264 89 0 • Fax +49 (0) 2264 89 266



Federal-Mogul Aftermarket UK Limited

Greyhound Drive • Bradford • BD7 1NQ • England
Phone +44 (0) 1274 723481 • Fax +44 (0) 1274 848282



Federal-Mogul Ibérica, S.L.

Federal-Mogul Aftermarket España, S.A.

Calle Alcarria, nº 2 • 28823 Coslada • Madrid • Spain
Phone: + 34 91 746 1900 • Fax: + 34 91 746 18 90



Federal-Mogul Aftermarket France

60-62, rue Danjou • 92517 Boulogne-Billancourt Cedex • France
Phone +33 (0) 1 46 94 27 00 • Fax +33 (0) 1 46 94 27 01

Service Commande de stock :

Phone +33 (0) 810 000 029 • Fax +32 34 50 80 26

Service Commande express :

Phone +33 (0) 810 000 029 • Fax +33 (0) 1 46 94 27 01



Federal-Mogul Aftermarket

Southern Africa (PTY) Ltd









33 Western Boulevard • City West • Johannesburg • South Africa
Phone +27 11 630 3000 • Fax +27 11 630 3040



Federal-Mogul Aftermarket Turkey

Meclisi, Mebusan Caddesi, No: 133 • Findikli - Istanbul 80040 • Turkey
Phone +90 212 292 6313 • Fax +90 212 292 6260



			
<p>GASKETS</p> <ul style="list-style-type: none"> Full Set Head Set Conversion Set Without cylinder head gasket Without seals Without rocker gasket Without valve stem seals Left Right Upper Lower Inlet Exhaust Set <p>MISCELLANEOUS</p> <ul style="list-style-type: none"> Front Rear Inner Outer <p>HEADBOLT</p> <ul style="list-style-type: none"> Male hex Female hex Male star Female star Male torx Female torx Teeth hex Small hex 	<p>DICHTUNGEN</p> <ul style="list-style-type: none"> Vollsatz Kopfsatz Kurbelgehäusesatz Zylinderkopfdichtung nicht enthalten Ohne Öldichtungen Ohne Zylinderkopfdeckeldichtungen Ohne Ventilschaftdichtungen Links Rechts Oben Unten Einlaß Auslaß Satz <p>VERSCHIEDENES</p> <ul style="list-style-type: none"> Vorne Hinten Innen Außen <p>ZYLINDERKOPFSCHRAUBEN</p> <ul style="list-style-type: none"> Sechskant Innensechskant Vielzahl Innenvielzahl Außen Torx Innen Torx Innenvielzahl Sechskant mit angegossener Scheibe 	<p>GUARNIZIONI</p> <ul style="list-style-type: none"> Serie motore completa Serie Smeriglio Serie Complementare Senza guarnizione testa cilindro Senza paraoli Senza coperchio valvole Senza paraoli gambo valvola Sinistro Destro Superiore Inferiore Aspirazione SCARICO Serie <p>MINUTERIA</p> <ul style="list-style-type: none"> Anteriore Posteriore Interna Esterna <p>VITI TESTA CILINDRO</p> <ul style="list-style-type: none"> Esagonale Brugola Esagonale Stellare 12 punte Cava a stella 12 punte Torx esterno Torx cava A scanalatura esagonale Esagono flangiato 	<p>JOINTS</p> <ul style="list-style-type: none"> Pochette complète Pochette rodage Pochette complément Joint de culasse non inclus Bagues d'étanchéité non inclus Joint de couvre culbuteurs non inclus Joints de queue de soupape non inclus Gauche Droite Supérieur Inférieur Admission Échappement Pochette <p>ARTICLES DIVERS</p> <ul style="list-style-type: none"> Avant Arrière Intérieur Extérieur <p>VIS DE CULASSE</p> <ul style="list-style-type: none"> Hexagonale Hexagonale type "Allen" Cannelée Cannelée intérieure/femelle Etoile "torx" mâle Etoile "torx" intérieure/femelle Cannelée intérieur Mâle hexagonale avec rondelle intégrée
<p></p> <p>JUNTAS</p> <ul style="list-style-type: none"> Juego Completo Conjunto de Cilindro Juego de Conversión Sin junta de culata Sin retenes Sin juntas de balancines Sin retenes de válvula Izquierda Derecha Superior Inferior Admisión Escape Juego <p>OTRAS PIEZAS</p> <ul style="list-style-type: none"> Delantero Trasero Interior Exterior <p>TORNILLOS</p> <ul style="list-style-type: none"> Hexagonal macho Hexagonal hembra Estrella macho Estrella hembra Torx macho Torx hembra Estrella hembra especial Hexagonal con arandela 	<p></p> <p>USZCZELKI</p> <ul style="list-style-type: none"> Kompletny zestaw Zestaw głowicowy - góra silnika Zestaw zamienny - dół silnika Bez uszczelki głowicowej Bez uszczelnień olejowych Bez uszczelki pod dekiel zaworów Bez uszczelnień zaworów Lewy/Lewa Prawy/Prawa Górny/Górna Dolny/Dolna Dolot Wydech Zestaw <p>RÓŻNE</p> <ul style="list-style-type: none"> Przedni Tylny Wewnętrzny Zewnętrzny <p>ŚRUBA GŁOWICOWA</p> <ul style="list-style-type: none"> Sześciokąt - męski Sześciokąt - żeński Gwiazda - męski Gwiazda - żeński Torx - męski Torx - żeński Sześciokąt - zębowy Sześciokąt - mały 	<p></p> <p>ПРОКЛАДКИ</p> <ul style="list-style-type: none"> Полный комплект Комплект прокладок ГБЦ Комплект для модернизации Без прокладки ГБЦ Без уплотнений Без прокладок рокеров Без масляемых колпачков Левый/Левая Правый/Правая Верхний/Верхняя Нижний/Нижняя Впускного Выпускного Комплект <p>РАЗНОЕ</p> <ul style="list-style-type: none"> Передний Задний Внутренний Внешний <p>БОЛТ ГБЦ</p> <ul style="list-style-type: none"> Шестигранник наружный Шестигранник внутренний "звездочка" наружная "звездочка" внутренняя "торкс" наружный "торкс" внутренний Зубчатый шестигранник Малый шестигранник 	<p></p> <p>الحشيات</p> <ul style="list-style-type: none"> المجموعة الكاملة مجموعة الرأس مجموعة التحويل بدون حشية رأس الأسطوانة بدون السدادات بدون حشية القلاب بدون سدادات ساق الصمام اليمنى اليسرى العليا السفلية السحب المجموعة <p>متنوعة</p> <ul style="list-style-type: none"> الأمامية الخلفية الداخلية الخارجية <p>مسمار الرأس</p> <ul style="list-style-type: none"> سداسي الذكر سداسي الأنثى نجمة ذكر نجمة أنثى النجمي الذكر النجمي الأنثى سداسي السنون سداسي صغير

Federal-Mogul ADVANCED ANTI-COUNTERFEIT PROGRAMME

The following features on all new GASKETS and HEADBOLTS packaging prove that the parts inside are Original Quality.



1 LOOK FOR THE HOLOSPOT®

The Holospot® label features a 4-digit alphanumeric code.

Please check it to make sure that:

- The 4-digit code appears in rainbow colours using the light of the magnifier and is different on each pack
- The Federal-Mogul logo also appears in the Holospot®. The last 4 digits of the alphanumeric code have to be the same as the ones in the Holospot®

2 CHECK THE UNIQUE CODE ONLINE AT WWW.FMECAT.EU

Each Federal-Mogul part has a unique code which is displayed on the labels in an alphanumeric and Data Matrix format. A Data Matrix code is a 2-dimensional (2-D) matrix barcode. The Unique Code can be verified in 3 different ways:

- Typing in the Unique Code
- Reading the 2-D code with a 2-D scanner
- Reading the 2-D code with mobile phone. Mobile phone should be equipped with at least 3.0 megapixel camera, auto-focus, large display and camera light. Download NeoReader™ software and check the list of manufacturers to see the models that are supported by the NeoReader at www.neoreader.com

3 PROTECTION

Special label design means any attempt to remove or swap the label will result in tearing

 Go to www.fmecat.eu for verification



